

ACME SCREW ASSEMBLIES

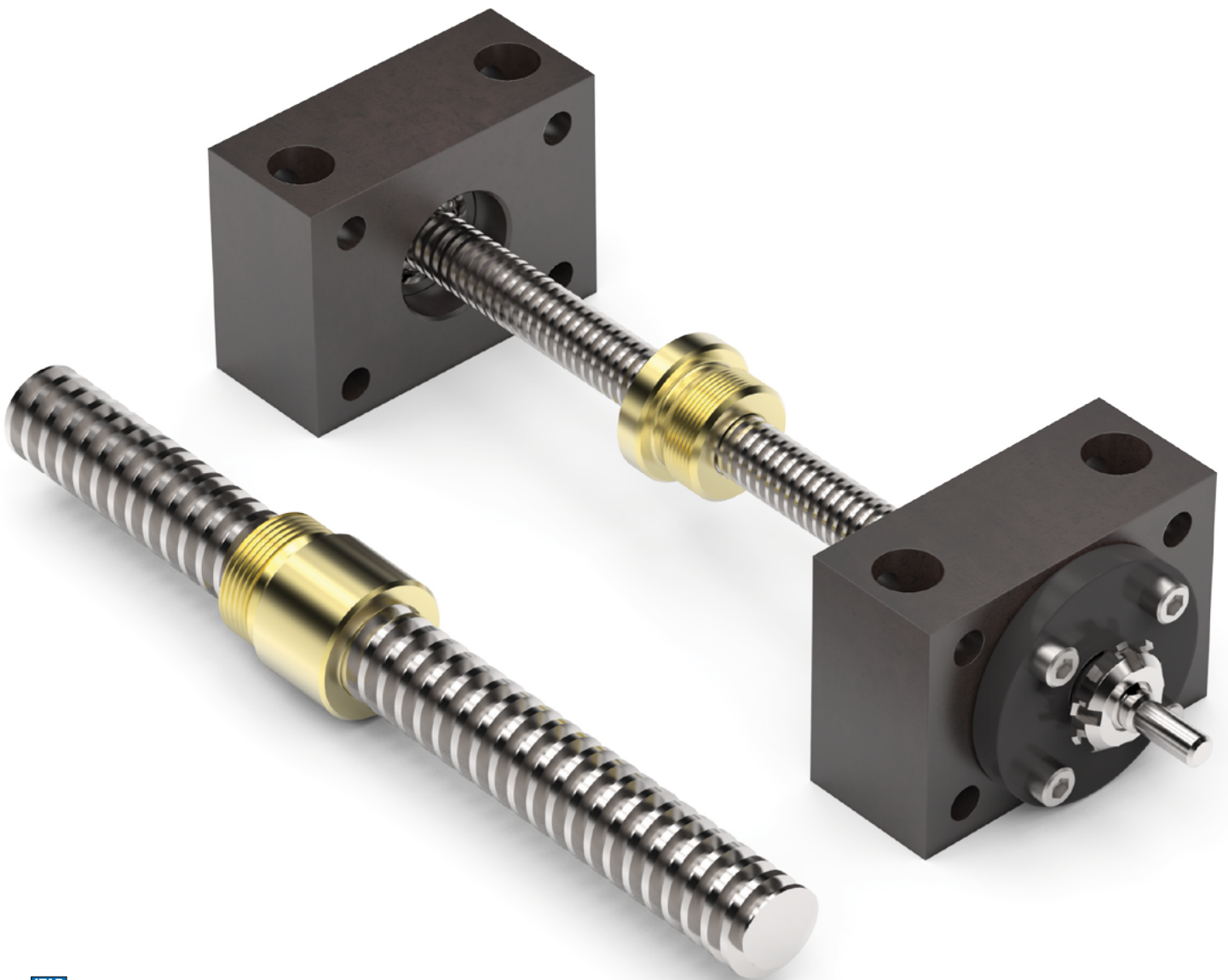



Helix Linear Technologies, Inc., Beachwood, Ohio USA

Helix Linear Technologies is the most high-tech lead screw manufacturing facility globally, producing the broadest product line of any lead screw manufacturer. We offer precision rolled, milled, and ground screws in diameters from 1.6 mm to 152.4 mm and leads from .3 mm to 75 mm. When you need Acme, Trapezoidal, or high-helix lead screws with precision low-backlash nuts, or a state-of-the-art anti-backlash design, we deliver the highest quality coupled with exceptional value.

Helix Linear Technologies offers a complete line of nuts in standard, anti-backlash, or custom designs with centralizing threads to match our precision lead screws, making our assemblies the lowest backlash product on the market. Our nuts come in various materials, including Acetal, PEEK, Bronze, Ertalyte, Carbon-Filled HPV, Turcite, Torlon, Vespel, PAI, PVDF, and medical-grade Acetal to fit your specific use and environment.

CULTURE

Our culture is rooted in teamwork and consists of smart, happy, and competitive professionals focused on manufacturing innovative products and delivering precise electromechanical linear motion solutions. We are in the people business, as well as the product business. Our talented employees make and sell our products, and our extraordinary scope of teamwork keeps our company healthy.

OPERATIONS

Our company delivers high-quality products and offers world-class engineering support, solving the most demanding linear motion applications across multiple industries. We manufacture components and subsystem solutions to high volume OEMs and custom machine builders to ensuring their success.

COMPANY

Helix Linear Technologies is a global supplier in the medical device, life science, security, semiconductor, aerospace, electromechanical, and defense industries. Leading the linear motion industry by manufacturing the highest quality linear actuation solutions in the world, we focus on helping our customers be productive and profitable. Our innovative product design solves real-world linear motion issues and builds a foundation for long term success.

HISTORY

Helix Linear Technologies was founded in 2011 to meet the demand for high-quality lead screws in the growing electromechanical actuation industry. Our rapid growth has included the addition of end-to-end linear actuator solutions, providing integrated solutions.

ACME Glossary and Technical Data

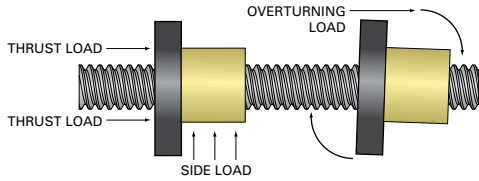

4-9

ACME Modular Assemblies

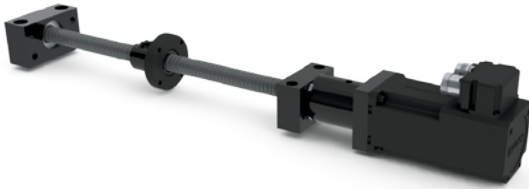

16-21

ACME Screws / Nuts



30-55

Trapezoidal Screws / Nuts



60-75

EZZE-MOUNT™ Bearing Mounts



86-91

COMPANY OVERVIEW	IFC
ACME SCREW MATERIALS AND MANUFACTURING	2-3
ACME GLOSSARY / TECHNICAL DATA	4-9
ACME COLUMN STRENGTH / CRITICAL SPEED CHARTS / QUICK REFERENCE	12-15
ACME MODULAR ASSEMBLIES	16-21
MOTOR MOUNTS / HANDWHEELS	22-25
LUBRICANTS	26
ACME REFERENCE NUMBER SYSTEM	27
ACME TWIN LEAD ASSEMBLIES	28-29
ACME SCREWS / NUTS 1/4" - 6"	30-55
TRAPEZOIDAL SCREW QUICK REFERENCE CHART / REFERENCE NUMBER SYSTEM	56-57
TRAPEZOIDAL COLUMN STRENGTH / CRITICAL SPEED CHARTS	58-59
TRAPEZOIDAL SCREWS / NUTS 8MM - 65MM	60-75
BEARING MOUNTS / END MACHINING GLOSSARY / TECHNICAL DATA	78-79
MACHINED ENDS DRAWINGS / CODES / END BEARING IDENTIFICATION	80-85
EZZE-MOUNT™ BEARING MOUNTS	86-91

PowerAC[™]
PRECISION LEAD
SCREW ASSEMBLIES

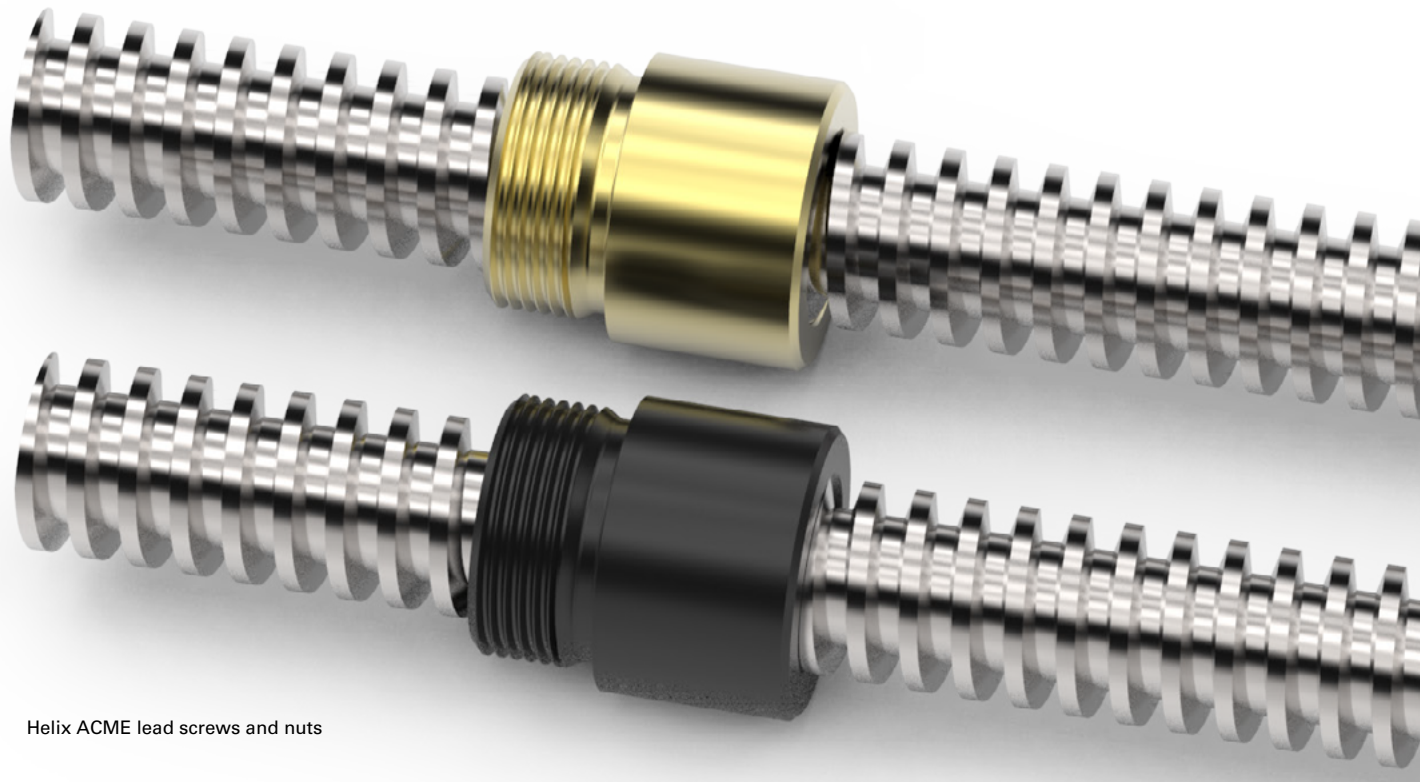

Helix ACME lead screws and nuts

ACME SCREWS

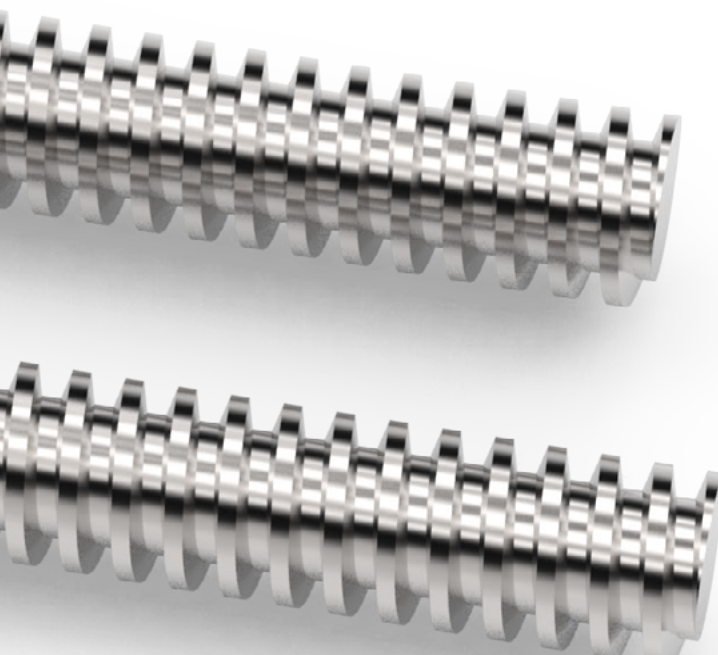

ACME SCREW ENGINEERING

PAGES 2-15

Acme Screw Materials & Manufacturing	2-3
Glossary and Technical Data	4-9
Application Example	10-11
Column Strength and Critical Speed:	
Acme Inch Screws	12-13
Quick Reference Chart	14-15

ACME SCREW ASSEMBLIES

PAGES 16-29

Modular Assemblies	16-20
Motor Mounts & Handwheels	21-25
Lubricant	26
Reference Numbers System	27
Twin-Lead Assemblies	28-29

ACME SCREWS AND NUTS

PAGES 30-55

1/4 to 5/16 Inch Acme Screws	30-31
3/8 Inch Acme Screws	32-35
1/2 Inch Acme Screws	36-37
5/8 Inch Acme Screws	38-39
3/4 and 7/8 Inch Acme Screws	40-41
1 Inch Acme Screws	42-45
1 1/8 to 1 1/4 Inch Acme Screws	46-47
1 1/2 Inch Acme Screws	48-49
1 3/4 to 2 1/4 Inch Acme Screws	50-51
2 1/2 to 3 3/8 Inch Acme Screws	52-53
3 3/4 to 6 Inch Acme Screws	54-55

TRAPEZOIDAL SCREW ENGINEERING

PAGES 56-59

Quick Reference, Reference System	56-57
Column Strength and Critical Speed:	
Trapezoidal Screws	58-59

TRAPEZOIDAL SCREWS AND NUTS

PAGES 60-75

8mm	60-61
10mm and 11mm	62-63
12mm	64-65
14mm	66-67
16mm	68-69
18mm and 20mm	70-71
26mm and 40mm	72-73
55mm and 65mm	74-75

ACME SCREWS AND NUTS MATERIALS & MANUFACTURING



Helix manufactures precision Acme screws by thread rolling, thread milling, or thread grinding processes. Each process produces high precision screws. Helix Acme screw products feature centralizing thread forms for smooth, no-wedging performance.

ROLLED ACME SCREWS

Helix offers the largest selection of rolled acme screw sizes in the industry. Rolled thread screws are cost effective and are stocked for quick delivery.

GROUND ACME SCREWS

Ground thread screws offer higher lead accuracy for applications where positioning tolerances are extremely critical.

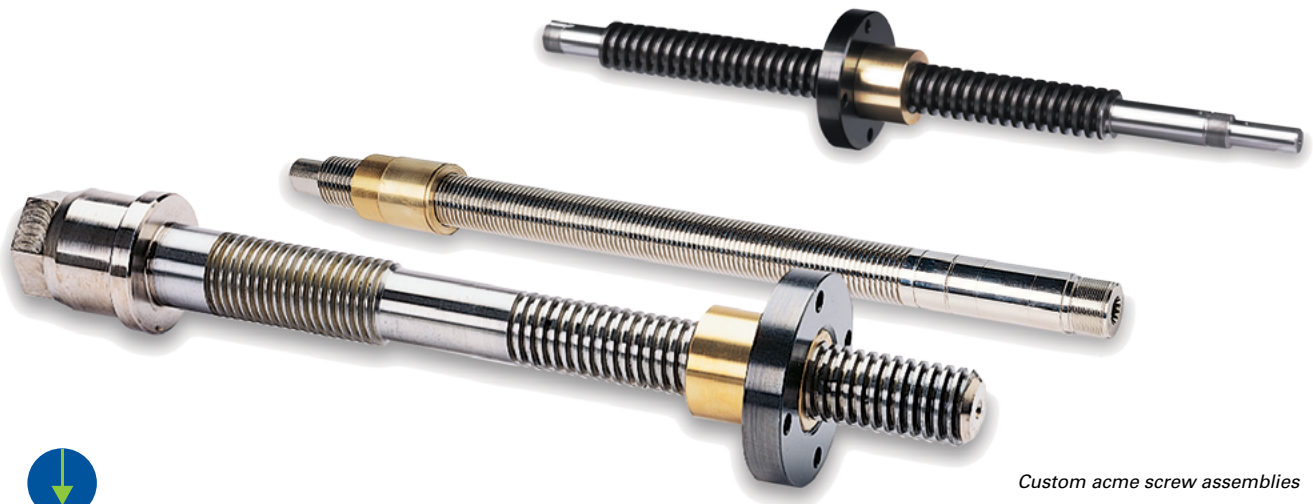

Custom acme screw assemblies





Helix acme screws are used in a variety of packaging applications



Mobile rocket launching system

SCREW TYPE	MATERIAL	THREAD CLASS	LEAD ACCURACY	SCREW DIA.	SCREW LENGTHS
Rolled	Alloy	Centralizing 2C or Stub	± .0003"/" up to 2½" dia.	¼" to 6"	Limited only by material availability
	Stainless	Centralizing 2C or Stub	± .0003"/" up to 1½" dia.	¼" to 1½"	Limited only by material availability
Ground	Alloy	Centralizing 3C or 4C	± .0005"/ft	¼" to 4"	up to 19"
	Stainless	Centralizing 2C or 3C	± .0005"/ft	¼" to 4"	up to 19"

	ACME & TRAPEZOIDAL ALLOY	STAINLESS STEEL
Screw Material	4140	300 Series
Minimum Hardness	200 Brinell	170 Brinell
Tensile Ultimate Strength	95,000 psi	85,000 psi
Finish	Black Oxide	Natural

Materials used in Helix Acme nuts have been selected for low friction, minimum wear, long life, and clean operation.

BRONZE ACME & TRAPEZOIDAL NUT

Special high tensile bronze is selected for our smooth running, anti-wedging bronze nuts.

- Material: Helix Bronze
- Tensile Yield: 50,000 psi
- Tensile Ultimate: 65,000 psi
- Hardness: HB75
- Dynamic co-efficient of friction: 0.125 with Helix Lubricant

Nut specifications can be found in the Quick References on pages 14-15 and 56. Flange and nut dimensions are listed with the appropriate screw data on pages 30-55 and 60-75.



PLASTIC ACME & TRAPEZOIDAL NUT

The high strength and inherent lubricity of plastic Acme and Trapezoidal nut material can result in product life that can equal or exceed conventional nut materials.

- Material: Helix Acetyl
- Tensile Strength @70°F: 8,000 psi
- Compressive Strength @70°F: 16,000 psi
- PV Limit: 2,700 lubricated
- Co-efficient of friction: 0.10 lubricated

POWERAC™ FLANGES FOR BRONZE & PLASTIC NUTS

Made from carbon steel with black oxide finish. See page 7 for Mounting and Pinning Acme Nut flange installation instructions.

GLOSSARY AND TECHNICAL DATA

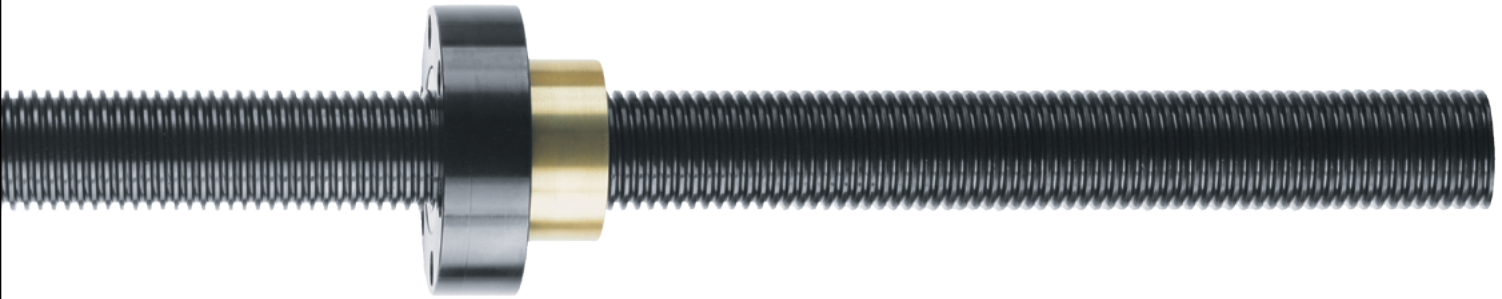

ACME THREAD FORM TERMS

THREAD TYPES - The Acme thread form, established over 100 years ago, replaced square thread screws, which had straight-sided flanks and were difficult to manufacture.

There are three main classes of Acme thread forms: General Purpose (G), Centralizing (C), and Stub Acme. The General Purpose and Centralizing thread forms have a nominal depth of thread of $0.50 \times \text{pitch}$ and have a 29° included thread angle. Some Helix sizes have 40° included angle. Trapezoidal thread forms have a 30° included thread angle.

When compared to general-purpose thread forms, centralizing threads are manufactured with tighter tolerances and reduced clearance on the major diameter.



Helix ACME screws are used in a variety of satellite dish applications

FIG. 1

NORMALLY LOADED NUT

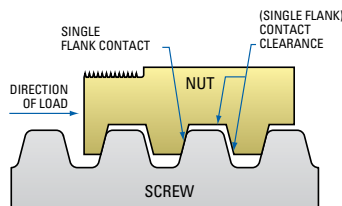

SIDE LOADED CONVENTIONAL 'G' CLASS NUT

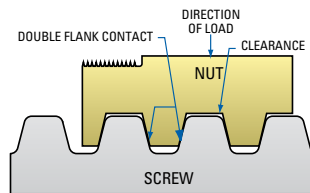

SIDE LOADED CENTRALIZED 'C' CLASS NUT

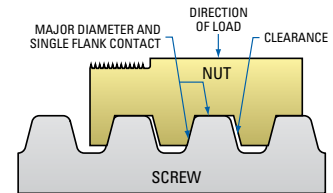

Stub Acme threads follow the same basic design, but have a thread depth less than one half the pitch.

If an Acme nut is side loaded with a radial load, a "G" class will "wedge" when the nut thread flanks come in contact with the screw thread flanks. To prevent wedging, less clearance and tighter tolerances are allowed between the major diameter of the nut and the major diameter of the screw.

CAUTION: Although a side load will not cause a centralizing thread to wedge, the nut is not designed to operate with a side load such as a pulley, drive belt, etc. See "Load Definition" section for further information. (See FIG. 1)



ACME screws in textile applications



ACME screws position solar panels



Lead screws position CNC laser cutting machines

SCREW STARTS - The number of independent threads on the screw shaft; example one, two or four. (See FIG. 2 below)

FIG. 2

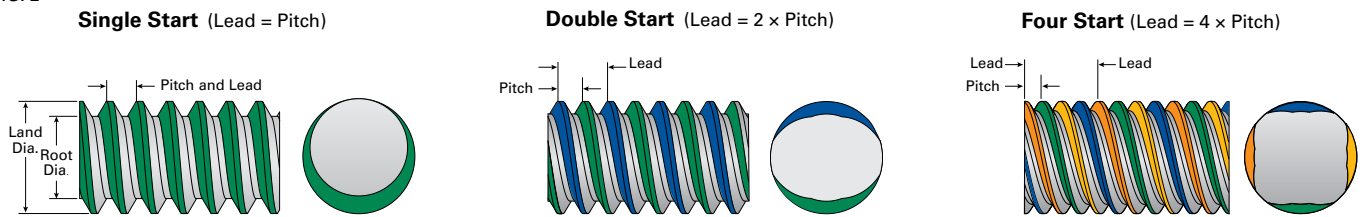

LAND (major) DIAMETER - The outside diameter of the screw.

PITCH DIAMETER - On an Acme screw, this diameter is approximately halfway between the land diameter and the root diameter. It is the diameter at which the thread thickness is equal to the space between threads.

ROOT (minor) DIAMETER - The diameter of the screw measured at the bottom of the thread.

PITCH - The axial distance between threads. Pitch is equal to the lead in a single start screw.

LEAD - The axial distance the nut advances in one revolution of the screw. The lead is equal to the pitch times the number of starts.

PITCH × STARTS = LEAD

NOTE: Helix Acme screw designations reference major diameter and effective turns per inch. For example: 1/4"–4 RH requires four turns for one inch of travel. A 1/4"–4 RH has 4 starts and a 0.062" pitch.

0.062" PITCH × FOUR STARTS = 0.250" LEAD

LEAD ACCURACY - Lead accuracy is the difference between the actual distance traveled versus the theoretical distance traveled based on lead. For example: A screw with a 0.5 inch lead and 0.004 inch per foot lead accuracy rotated 24 times theoretically moves the nut 12 inches. (24 Revolutions × .500 inches per revolution = 12.000 inches of travel)

With a Lead accuracy of .0003"/inch, actual travel could be from 11.996 to 12.004 inches.

Refer to the listings in the design guide for the lead accuracy of a particular screw.

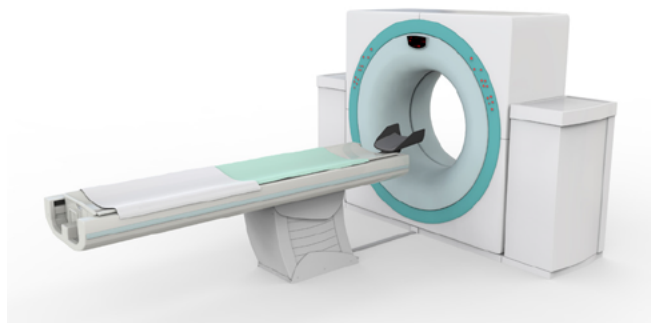

Helix lead screws are used in patient tables for MRI's

-  lubricants p.26
-  twin-lead screws p.28
-  end machining p.77
-  EZZE-MOUNT™ bearing supports p.77
-  screw assemblies p.16

GLOSSARY AND TECHNICAL DATA *(continued)*

Matched Lead - When multiple screws are used to move a load with precise synchronicity, screws of similar lead accuracy can be factory selected and supplied as sets. Consult factory for matched lead set tolerances.

Straightness - Although PowerAc™ Acme Screws are manufactured from straight, cylindrical material, internal stresses may cause the material to bend or yield.

When ordering random lengths or cut material without end machining, straightening is recommended. Handling or machining of screws can also cause the material to bend or yield. Before, during and after machining, additional straightening is required. When ordering screws with machined ends from Helix, the following straightness tolerances can be expected:

PowerAc Rolled Acme Screws are straight within 0.010 inch/foot and will not exceed 0.030 inch in any 6-foot section, when shipped from the factory.

PowerAc Ground Acme Screws are straight within 0.001 inch/foot when shipped from the factory. If tighter straightness tolerances are required, contact Helix customer service.

Life - PowerAc Acme Screws are manufactured from high quality materials with excellent dynamic properties. Because of the variable effects of friction, lubrication and cleanliness, a specific life cannot be predicted. Proper lubrication, regular maintenance, and operation within specified limits will extend the life of PowerAc Acme Screws.

Efficiency - Efficiency of PowerAc Acme Screw assemblies range from 15% to 85%. These efficiencies are dependent upon nut material, lubrication, lead and thread form. The efficiencies for each assembly are listed on the following pages.

Backdriving - Normally, Acme screws are used to convert rotary motion into linear motion. Backdriving is the result of the load pushing axially on the screw or nut to create rotary motion. Generally, a nut with efficiency greater than 50% will have a tendency to backdrive. If a self-locking assembly is required, select a nut with efficiency below 35%.

CAUTION: Vibration can cause any acme screw assembly to creep or backdrive. When using lead screws, applications should be analyzed to determine the necessity of a brake, especially when the possibility of injury may occur.

FIG. 3 Adjustable backlash nut assembly

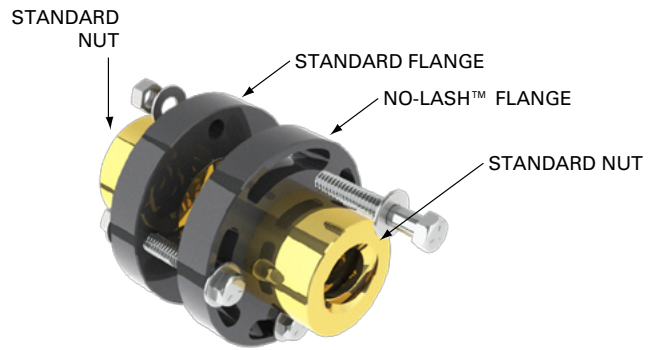

Backlash - Backlash (lash) is the relative axial clearance between a screw and nut without rotation of the screw or nut. Backlash information for PowerAc Acme Screws and Nuts is listed within the data section of this catalog. Lash will always increase with use. Helix has developed several unique ways to reduce or remove the lash between the screw and nut.

For screw diameters over 5/8 inch, PowerAc No-Lash™ Flanges are available. The PowerAc No-Lash Flange is identical to a standard flange except for slotted mounting holes. The backlash can be removed by using a nut with a PowerAc No-Lash Flange in combination with a standard nut and flange. By rotating the slotted PowerAc No-Lash Flange and nut relative to the other, the thread in the second nut advances until the lash is reduced.

As the nuts wear and backlash increases, loosen the mounting bolts and readjust the PowerAc No-Lash Flange and nut until the lash is minimized. (See FIG. 3)

For a complete PowerAc No-Lash Flange assembly order 2 standard nuts, 1 standard flange and 1 No-Lash Flange. For example a 3/4"-2 assembly requires the following:

2	-	20072	Standard Nuts
1	-	70262	Standard Flange
1	-	73262	No-Lash™ Flange

CAUTION: When the uncompensated lash is equal to or greater than times the pitch, the assembly should be replaced.

LOAD DEFINITIONS

Static Load - The maximum thrust load – including shock – that should be applied to a non-moving PowerAc Acme nut assembly. Actual maximum static load may be reduced based on end machining and screw mounting hardware.

Dynamic Load - The maximum recommended thrust load which should be applied to the PowerAc Acme screw and nut assembly while in motion.

PV Load - Any material which carries a sliding load is limited by heat buildup caused by friction. The factors that affect heat generation rate in an application are the pressure on the nut in pounds per square inch of contact area and the surface velocity in feet per minute at the major diameter. The product of these factors provides a measure of the severity of an application.

Tension Load - A load that tends to “stretch” the screw. (See FIG. 4)

Compression Load - A load that tends to “squeeze” the screw. (See FIG. 4)

FIG. 4

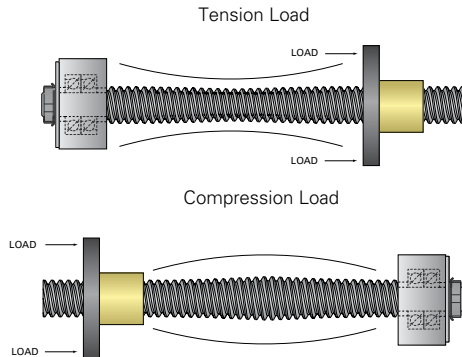

Thrust Load - A load parallel to and concentric with the axis of the screw. (See FIG. 5)

Overturning Load - A load that tends to rotate the nut radially around the longitudinal axis of the screw. (See FIG. 5)

Side Load - A load that is applied radially to the nut. (See FIG. 5)

FIG. 5

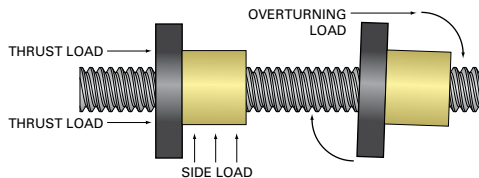

DESIGN CONSIDERATIONS

Mounting and Pinning of Acme Flange

Flanges must be secured to Acme nuts. The preferred method of locking a flange to a nut is a pin or set screw parallel to the screw which intersects the flange/nut mounting thread. Because of the dissimilarity of materials, the hole may need to be milled, not drilled. Alternatively, the flange may be drilled and tapped radially for a set screw. After assembly of the flange to the nut, spot drill the nut threads through the flange and install a dog point set screw from the flange O.D. into the nut O.D. threads. Avoid getting metal chips in the nut when drilling. (See FIG. 6 and 7 for pin size)

FIG. 6

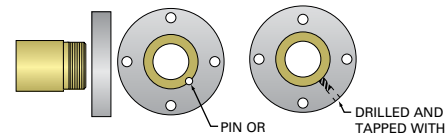

FIG. 7

DIAMETER	DESCRIPTION	QTY
up to .625	1/8 x 1/4 Slotted Spring Pin	1
.75 to 1.0	#10 - 24 x 1/4 Set Screw	1
1.125 to 1.375	1/4 - 20 x 1/4 Set Screw	2
1.5 to 3.0	5/16 - 18 x 1/2 Set Screw	2
3.375	3/8 - 16 x 3/4 Set Screw	2
4+	1/2 x 13 x 1 Set Screw	2

Commercially available thread adhesives may be used for light load applications. Follow the manufacturers’ recommendations to ensure a satisfactory bond. Avoid getting the adhesive onto the acme screw thread.

Lubrication - Proper lubrication must be provided to achieve satisfactory service life. Helix PowerAc lubricant (E-100 spray lube or PAG-1 grease) is recommended for applications using PowerAc nuts. Lubrication intervals are determined by the application. It is required that screw assemblies are lubricated often enough to maintain a film of lubricant on the screw.

Driving Torque - Driving torque is the torque required to move a load and is calculated by multiplying the force needed by the “Torque to raise one lb” value listed in the technical data section for each screw and nut size.

EXAMPLE: To lift a 1,000 lb load using a 1” - 6 RH Acme screw with plastic nut, 74 in lb of torque are required.

$$.074 \text{ in-lb/lb} \times 1000 \text{ lb} = 74 \text{ in lb}$$

GLOSSARY AND TECHNICAL DATA *(continued)*

DESIGN CONSIDERATIONS *(continued)*

Temperature - With proper lubrication, PowerAc™ Acme Screws with bronze nuts operate efficiently between 15°F and 350°F, and plastic nuts between 15°F and 175°F. Consult the factory for low temperature applications.

End Machining - To obtain optimum performance of your acme screw assembly, it is recommended that the machining be performed at the Helix factory. Screws may be purchased machined to your specifications or to standard end machining designs shown on page 77.

EZZE-MOUNT™ - Acme screws in operation generate an axial load and a radial load; therefore, end mounts must be designed to accommodate these loads. Helix has designed precision end mounts to work specifically with acme screws. For a detailed description of these bearing supports, see pages 77-91. An EZZE-MOUNT can be shipped pre-assembled to a PowerAc™ Acme Screw. For complete PowerAc™ Acme Screw Assemblies refer to pages 16-25.

Optional Surface Coatings - Consult Helix engineers for specific surface coatings for anti-corrosion and lubrication.

Boots and Bellows - For contaminated environments, use of a boot or metal cover to protect the acme screw assembly is recommended.

ACME SCREW SELECTION

The selection of the correct Acme screw and nut for a particular application involves four interrelated factors. Before attempting to determine the Acme screw and nut combination, the following values must be known:

- Axial load measured in pounds or newtons
- Speed measured in inches or millimeters per minute
- Length between bearings measured in inches or millimeters
- End fixity type

Load - The loads that need to be considered are the static loads, dynamic loads, reaction forces and any external forces affecting the screw. See Load definitions section on page 7 for details.

Speed - The travel rate (linear speed) is the rpm at which the screw or nut is rotating multiplied by the lead of the screw.

Length - The unsupported length of the screw.

End Fixity - End fixity refers to the method by which the ends of the screw are supported. The degree of end fixity is related to the amount of restraint of the ends of the screw. Examples of the three basic types of end fixity are:

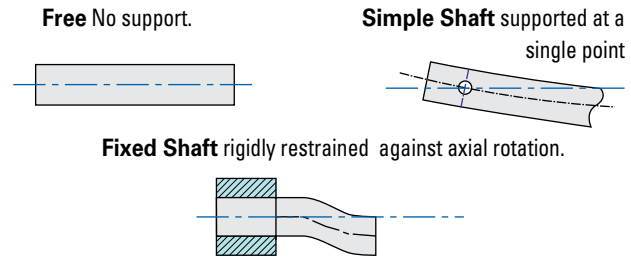

Simple End fixity can be provided through a single bearing support. Multiple or spaced pairs of bearings are more rigid than a "Simple" support, but because of their compliance are not truly "Fixed". A screw can be supported with different combinations of end fixity. (See FIG. 8)

FIG. 8

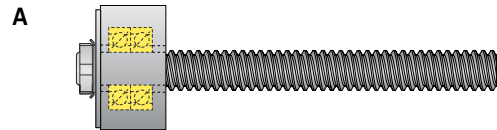

One end with a Double Bearing EZZE-MOUNT, other end Free. Use Line A in reference to the charts shown on pages 12-13 and 58-59. **NOTE:** Not recommended for any application other than short travels and slow speeds.

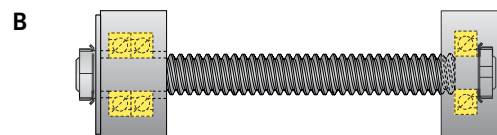

One end supported with a Double Bearing EZZE-MOUNT, other supported with a Single Bearing EZZE-MOUNT. Use Line B in reference to the charts shown on pages 12-13 and 58-59.

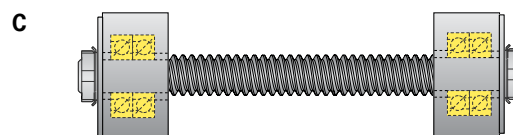

Both ends supported with a Double Bearing EZZE-MOUNT. Use Line C in reference to the charts shown on pages 12-13 and 58-59.

FIG.8 (Cont'd)

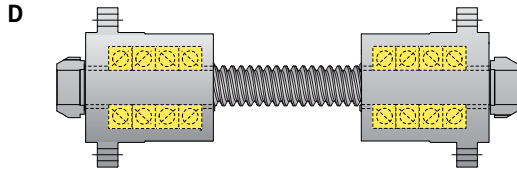

Both ends supported with a Quad Bearing EZRF EZZE-MOUNT. Use Line D in reference to the charts shown on pages 16-17 and 62-63.

NOTE: When supporting a screw with two Quad Bearing EZRF Mounts, the screw is highly ridged and extra care should be taken to insure compliance in the assembly design.

Critical Speed - Once the load, speed, length and end fixity are identified, the next factor to consider is the critical speed. The speed that excites the natural frequency of the screw is referred to as the critical speed. Resonance at the natural frequency of the screw will occur regardless of the screw orientation (vertical, horizontal etc.) or if the system is designed so the nut rotates about the screw. The critical speed will vary with the diameter, unsupported length, end fixity and rpm. Since critical speed can also be affected by shaft straightness and assembly alignment, it is recommended that the maximum speed be limited to 80% of the calculated critical speed. The theoretical formula to calculate critical speed in rpm is:

$$N = \frac{C_s \times 4.76 \times 10^6 \times d}{L^2}$$

WHERE:

- N = Critical Speed (rpm)
- d = Root Diameter of Screw (inch)
- L = Length Between Bearing Supports (inch)
- C_s = 0.36 for one end fixed, one end free
1.00 for both ends simple
1.47 for one end fixed, one end simple
2.23 for both ends fixed

The critical speed chart on pages 13 and 59 are provided to quickly determine the minimum screw size applicable for Helix EZZE-MOUNT designs. If the selected Acme screw does not meet critical speed criteria, consider the following options:

- a) Increase screw lead and reduce rpm
- b) Change end fixity (e.g. simple to fixed)
- c) Increase screw diameter

Column Strength - When a screw is loaded in compression (see compression load definition on page 11), its limit of elastic stability can be exceeded and the screw will fail through bending or buckling.

The theoretical formula to calculate the column strength in pounds is:

$$P_{cr} = \frac{14.03 \times 10^6 \times F_c \times d^4}{L^2}$$

WHERE:

- P_{cr} = Maximum Load (lb)
- F_c = End Fixity Factor
0.25 for one end fixed, one end free
1.00 for both ends supported
2.00 for one end fixed, one end simple
4.00 for both ends rigid
- d = Root Diameter of Screw (inch)
- L = Distance between nut and load carrying bearing (inch)

The column strength chart on page 16 may be used to verify that the screw can carry the required load without buckling.

The charts show the theoretical limitations of each screw on a separate line. The lines are limited horizontally by the slenderness ratio and vertically by the maximum static capacity of the bronze nut. Actual load is limited by the maximum nut capacity.

If the selected screw does not meet compression load criteria, consider the following options:

- a) Change end fixity (e.g. simple to fixed)
- b) Design to use screw in tension
- c) Increase screw diameter

PV Value - For plastic nuts, the PV value needs to be checked (see the PV load definition page 11) The operating load values for the plastic nuts are based on a pressure of 1,250 lb per square inch. Any loads less than the operating load can be evaluated by using the following formula:

$$P = \frac{\text{Actual Operating Load}}{\text{Chart Operating Load}} \times 1250$$

V is the relative speed between the nut and the screw in feet per minute. **V** can be calculated by using the following formula:

$$V = \frac{\text{Outside Dia. (in) of the Screw} \times \pi \times \text{Operating Speed (rpm)}}{12}$$

It is recommended that P × V be limited to values less than 2,700.



APPLICATION EXAMPLE

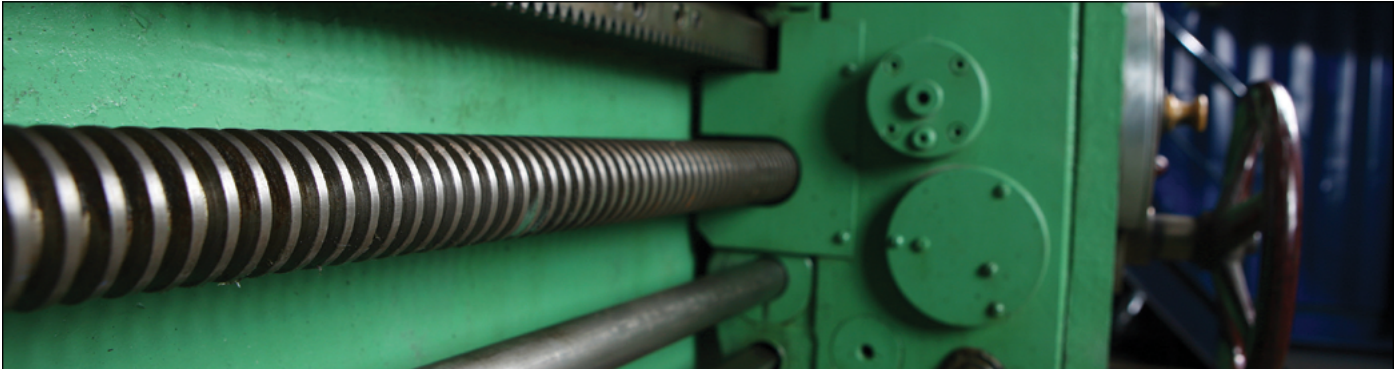

Helix acme screw used in a manual lathe

APPLICATION

Given the following requirements, select an Acme screw for an application which uses Acme screws for an automatic part feeder on a machine.

Specifications:

- 5,000 lb load supported and guided on linear bearings moving horizontally
- 36" travel
- Complete 36" travel in 10 seconds
- Bearing Support Undecided
- Positioning accuracy $\pm 1/4$ "

STEP 1

Find the axial force required to move load. The axial force is determined by multiplying the coefficient of friction of the guidance system by the load.

$$F = \mu \times N$$

μ = coefficient of friction of the guidance system

Using Helix linear bearings in this application;

$$\begin{aligned} \mu &= \text{Coefficient of Friction for lubricated Helix Linear Bearings} = .0013 \\ N &= \text{Load} = 5000 \text{ pounds} \\ F &= \mu \times N \\ F &= .0013 \times 5000 \text{ lb} \\ F &= 6.5 \text{ lb} \end{aligned}$$

Therefore: The Axial Force the screw must produce to move the load is 6.5 lb.

STEP 2

Find Average Travel Rate.

The average travel rate is determined by dividing travel distance by travel time.

$$\begin{aligned} V_{\text{avg}} &= D/t \\ D &= \text{distance} = 36 \text{ inches} \\ t &= \text{total time} = 10 \text{ seconds} \\ V_{\text{avg}} &= D/t \\ V_{\text{avg}} &= 36 \text{ in}/10 \text{ seconds} \\ V_{\text{avg}} &= 3.6 \text{ in/sec. or } 216 \text{ in/minute} \end{aligned}$$

Therefore: The average travel rate is 216 in/minute

STEP 3

Find Maximum Travel Rate. When considering critical speed, peak velocity should be used. Using a basic triangular motion profile (acceleration = deceleration with no constant velocity travel), the peak velocity equals twice the average velocity.

$$\begin{aligned} V_{\text{peak}} &= 2 \times V_{\text{avg.}} \\ V_{\text{avg}} &= 3.6 \text{ in/sec. or } 216 \text{ in/minute} \\ V_{\text{peak}} &= 2 \times V_{\text{avg.}} \\ V_{\text{peak}} &= 432 \text{ in/minute} \end{aligned}$$

The Maximum Travel Rate is 432 in/min during the traverse of 36 inches in 10 seconds.

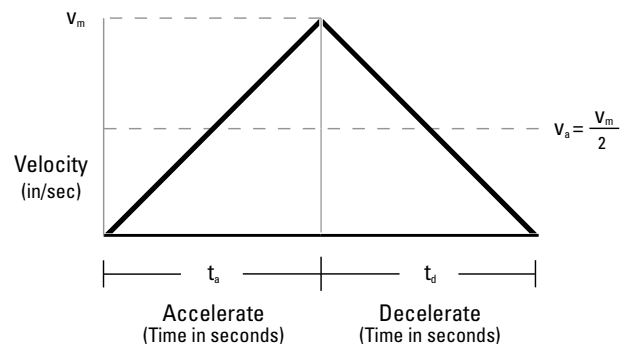

STEP 4

Determine total unsupported length. Total Travel is given as 36 inches, but extra screw length should be considered for travel nut, carriage, and or any extra screw length for over-travel. Based on the travel nut and attachment of the nut to the carriage in this application, it is determined an extra 4" of screw length will be required. (Refer to the dimensional information of the particular nut used).

$$L \text{ TOTAL} = 36 \text{ IN} + 4 \text{ IN} = 40 \text{ INCHES}$$

The total unsupported length to be used for critical speed and column loading calculations is 40 inches.

STEP 5

Determining end fixity. The layout of the application shows that adequate space is available to use a double bearing EZZE-MOUNT at each end. (See end fixity definitions on page 8) End Fixity = Type C.

STEP 6

Select a screw based on the critical speed. Use previously determined values with the Critical Speed chart on page 13.

- Max Travel Rate = 432 in/min
- End Fixity = Type C
- Length Between Bearing Supports = 40 inches

Based on the Critical Speed Chart, a 1" - 5 Acme Screw (1 inch diameter, 5 threads per inch) is selected.

STEP 7

Check Column Strength of screw. Use previously determined values with the Column Strength chart on page 16.

- Load = 6.4 pounds
- End Fixity = Type C
- Length Between Bearing Supports = 40 inches
- Based on the Column Strength Chart, the load is within the column strength of this screw.

NOTE: If this were a vertical application, the full 5,000 pound load would be used. Also, under high acceleration conditions, the inertia load must be determined and added to the total load for column considerations.

STEP 8

Check the PV Value. This relates the pressure load to the speed of the nut. First find the actual P value based on the calculation. Using the formulas from page 9:

$$P = \frac{\text{Actual Operating Load}}{\text{Nut Dynamic Load Capacity}} \times 1250 \text{ psi}$$

$$\frac{6.5 \text{ pounds}}{2,500 \text{ pounds}} \times 1250 \text{ psi} = 3.2 \text{ psi}$$

Next the "V" value or maximum relative speed between the screw and nut is:

$$V = \frac{\text{Outside Dia. (in.)} \times \pi \times \text{Operating Speed (rpm)}}{12 \text{"/ft.}}$$

$$\frac{1 \text{"} \times \pi \times 2160 \text{ rpm}}{12 \text{"/ft.}} = 565 \text{ ft/per minute}$$

This results in a PV value of 3.2 times 565 or 1,808 below the maximum recommended value of 2,700.

STEP 9

Create a reference number for the assembly. See page 27 for Reference Number System Chart. The 1" - 5 Acme Screw is thread form code 105. The screw material is right-hand thread, alloy steel. The end code used for machining this screw is end code 17. The type of machining will be a Type 3 on both ends of screw to allow for mounting a double bearing.

EZZE-MOUNT. One end will have a section to attach a coupling, the other will not. To determine the overall length of the assembly, add up the length of the ends plus the unsupported length:

- One end Type 3K (drive end with keyway) = 3.65"
- One end Type 3N (no drive end) = 2.33"
- 40 inches between supports
- Over-all length is 40" + 3.65" + 2.33" = 45.98"

The Part List Includes:

- One Plastic Acme Nut – 30105
- One Steel Flange - 70275
- EZZE-MOUNT Bearing blocks (2 req'd) - EZM-3017

To receive an assembly of these components with the EZZE-MOUNT, nut, and flange installed on the screw, the order reference number is:

105 - RA/EK/EN/45.98/30105/FS

NOTE: The nut will be installed with the flange facing toward the first specified end. In this example, the EK end.



COLUMN STRENGTH: ACME INCH SCREWS

TO USE THIS CHART: Find a point at which the maximum length between bearing support and acme nut intersects the maximum load. Be sure the screw selected is above and to the right of that point.

Acme Screws are limited by both Maximum Static Load and Slenderness Ratio. See pages 8-9 for reference description on A-B-C-D end fixity.

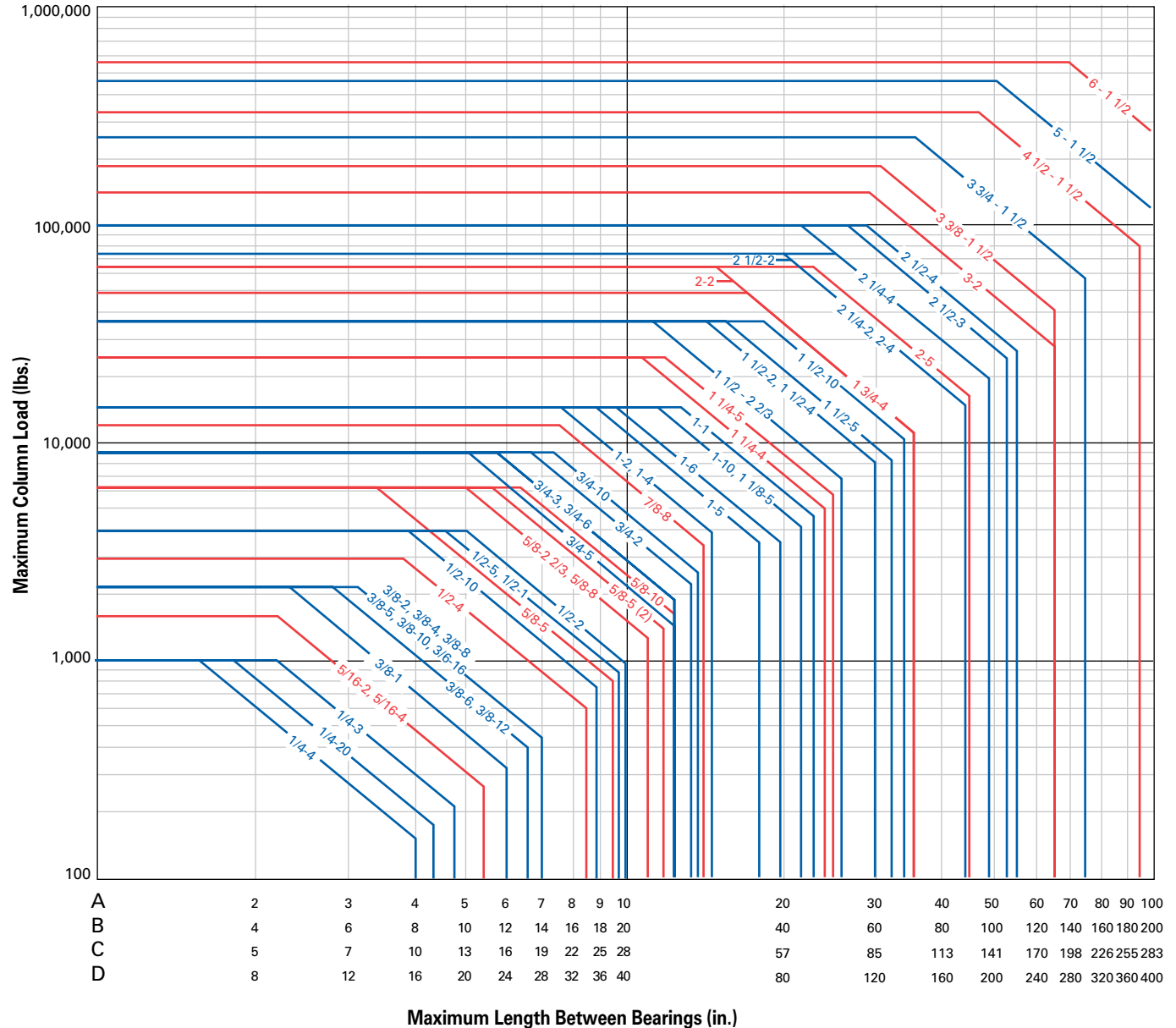

CRITICAL SPEED: ACME INCH SCREWS

TO USE THIS CHART: Determine maximum travel rate required. Determine screw length L. Find point at which travel rate and screw length intersect and select a screw above and to the right of that point.

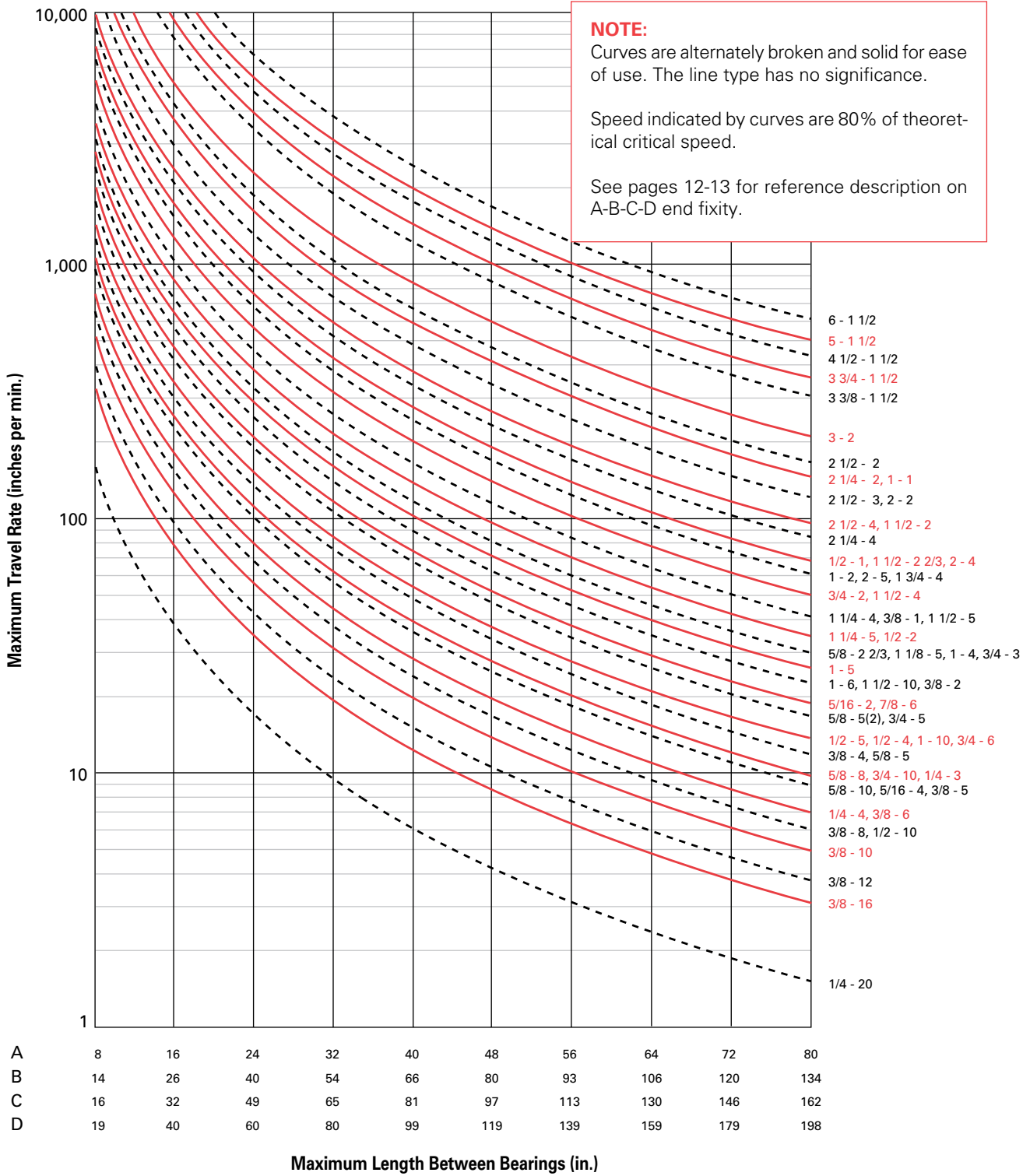

ACME SCREW ASSEMBLIES

The specifications and data in this publication are believed to be accurate and reliable. However, it is the responsibility of the product user to determine the suitability of Helix Linear Technologies products for a specific application. While defective products will be replaced without charge if promptly returned, no liability is assumed beyond such replacement.

QUICK REFERENCE: ACME INCH SCREWS AND NUTS

NUT SELECTION

SCREW SIZES SIZE DIA Turns Per in	BRONZE							PLASTIC				Back Lash (max)	Page ref
	Lead	Pitch	Root Dia.	Load Rating		Torque to raise 1 lb (in lb)	Efficiency %	Load Rating		Torque to raise 1 lb (in lb)	Efficiency %		
				Static (lb)	Dynamic lb			Static (lb)	Dynamic (lb)				
1/4 - 3	.333	.083	.192	1,000	312	.073	73	156	156	.067	79	.005	35
1/4 - 4	.250	.062	.162	1,000	312	.056	71	156	156	.053	75	.007	35
1/4 - 20	.050	.050	.175	1,000	312	.022	36	156	156	.020	40	.006	35
5/16 - 2	.500	.125	.216	1,625	500	.107	74	205	205	.054	73	.008	35
5/16 - 4	.250	.125	.216	1,625	510	.059	67	205	205	.054	73	.008	35
3/8 - 1	1.000	.200	.238	2,250	703	.210	77	351	351	.199	80	.021	37
3/8 - 2	.500	.125	.278	2,250	703	.107	74	351	351	.101	79	.009	37
3/8 - 4	.250	.125	.278	2,250	703	.063	63	351	351	.057	69	.009	37
3/8 - 5	.200	.100	.282	2,250	703	.054	59	351	351	.050	64	.008	37
3/8 - 6	.166	.083	.263	2,250	703	.049	54	351	351	.044	60	.006	37
3/8 - 8	.125	.125	.278	2,250	703	.042	48	351	351	.037	54	.009	39
3/8 - 10	.100	.100	.282	2,250	703	.038	42	351	351	.033	48	.008	39
3/8 - 12	.083	.083	.263	2,250	703	.036	37	351	351	.031	43	.006	39
3/8 - 16	.062	.062	.286	2,250	703	.031	32	351	351	.028	35	.007	39
1/2 - 1	1.000	.125	.392	4,000	1,250	.210	77	625	625	.196	80	.007	41
1/2 - 2	.500	.100	.406	4,000	1,250	.115	69	625	625	.107	75	.006	41
1/2 - 4	.250	.125	.332	4,000	1,250	.070	57	625	625	.064	63	.007	41
1/2 - 5	.200	.100	.391	4,000	1,250	.061	52	625	625	.056	57	.009	41
1/2 - 10	.100	.100	.359	4,000	1,250	.047	34	625	625	.039	40	.007	41
5/8 - 2 2/3	.375	.125	.457	6,250	1,953	.100	60	976	976	.091	66	.010	43
5/8 - 5	.200	.200	.377	6,250	1,953	.072	44	976	976	.060	53	.009	43
5/8 - 5(2)	.200	.100	.484	6,250	1,953	.069	46	976	976	.062	51	.009	43
5/8 - 8	.125	.125	.457	6,250	1,953	.058	34	976	976	.049	40	.008	43
5/8 - 10	.100	.100	.516	6,250	1,953	.053	30	976	976	.046	35	.009	43
3/4 - 2	.500	.125	.581	9,000	2,812	.129	62	1,406	1,406	.118	68	.010	45
3/4 - 3	.333	.167	.537	9,000	2,812	.099	54	1,406	1,406	.089	60	.009	45
3/4 - 5	.200	.200	.502	9,000	2,812	.080	40	1,406	1,406	.066	48	.009	45
3/4 - 6	.166	.166	.537	9,000	2,812	.073	36	1,406	1,406	.061	43	.008	45
3/4 - 10	.100	.100	.608	9,000	2,812	.064	25	1,406	1,406	.052	30	.007	45
7/8 - 6	.166	.166	.661	12,250	3,828	.083	32	1,914	1,914	.068	39	.009	45

NUT SELECTION

SCREW SIZES SIZE DIA Turns Per in	Lead Pitch Root Dia.			BRONZE				PLASTIC				Back Lash (max)	Page ref
				Load Rating		Torque to raise 1 lb (in lb)	Efficiency %	Load Rating		Torque to raise 1 lb (in lb)	Efficiency %		
				Static (lb)	Dynamic (lb)			Static lb	Dynamic lb				
1 - 1	1.000	.100	.906	16,000	5,000	.231	69	2,500	2,500	.216	74	.008	47
1 - 2	.500	.250	.698	16,000	5,000	.139	57	2,500	2,500	.127	63	.010	47
1 - 4	.250	.250	.698	16,000	5,000	.105	38	2,500	2,500	.086	46	.010	47
1 - 5	.200	.200	.750	16,000	5,000	.094	34	2,500	2,500	.079	40	.009	49
1 - 6	.167	.167	.786	16,000	5,000	.089	30	2,500	2,500	.074	36	.009	49
1 - 10	.100	.100	.857	16,000	5,000	.078	20	2,500	2,500	.065	24	.008	49
1 1/8 - 5	.200	.200	.875	20,500	6,330	.100	32	3,165	3,165	.085	37	.010	51
1 1/4 - 4	.250	.250	.947	25,000	7,812	.117	34	3,906	3,906	.099	40	.011	51
1 1/4 - 5	.200	.200	.999	25,000	7,812	.114	28	3,906	3,906	.092	35	.010	51
1 1/2 - 2	.500	.250	1.196	36,000	11,250	.173	46	5,650	5,650	.187	52	.012	53
1 1/2 - 2 2/3	.375	.375	1.066	36,000	11,250	.149	40	5,650	5,650	.161	46	.010	53
1 1/2 - 4	.250	.250	1.196	36,000	11,250	.133	30	5,650	5,650	.145	36	.010	53
1 1/2 - 5	.200	.200	1.249	36,000	11,250	.127	25	5,650	5,650	.139	31	.010	53
1 1/2 - 10	.100	.100	1.355	36,000	11,250	.110	15	5,650	5,650	.126	21	.009	53
1 3/4 - 4	.250	.250	1.427	49,900	15,312	.153	26	7,650	7,650	.164	30	.011	55
2 - 2	.500	.500	1.410	64,000	20,000	.199	40	**	**	**	**	.020	55
2 - 4	.250	.250	1.694	64,000	20,000	.166	24	**	**	**	**	.012	55
2 - 5	.200	.200	1.747	64,000	20,000	.159	20	**	**	**	**	.011	55
2 1/4 - 2	.500	.500	1.684	81,000	25,312	.215	37	**	**	**	**	.021	55
2 1/4 - 4	.250	.250	1.944	81,000	25,312	.181	22	**	**	**	**	.012	55
2 1/2 - 2	.500	.500	1.908	100,000	31,250	.234	34	**	**	**	**	.012	57
2 1/2 - 3	.333	.333	2.106	100,000	31,250	.212	25	**	**	**	**	.013	57
2 1/2 - 4	.250	.250	2.193	100,000	31,250	.199	20	**	**	**	**	.012	57
3 - 2	.500	.500	2.410	144,000	45,000	.265	30	**	**	**	**	.016	57
3 3/8 - 1 1/2	.666	.667	2.652	192,000	60,000	.312	34	**	**	**	**	.020	57
3 3/4 - 1 1/2	.666	.667	3.083	260,000	81,000	.345	30	**	**	**	**	.020	59
4 1/2 - 1 1/2	.666	.667	3.782	320,000	100,000	.379	28	**	**	**	**	.022	59
5 - 1 1/2	.666	.667	4.286	470,000	145,000	.398	26	**	**	**	**	.022	59
6 - 1 1/2	.666	.667	5.254	576,000	180,000	.474	22	**	**	**	**	.025	59

** Contact our sales engineers.



STANDARD HELIX COMPONENTS AND SERVICES

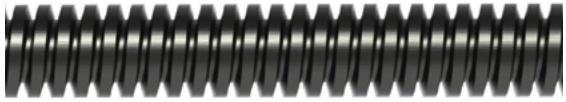

Acme Screw



Bronze Nut



Flange

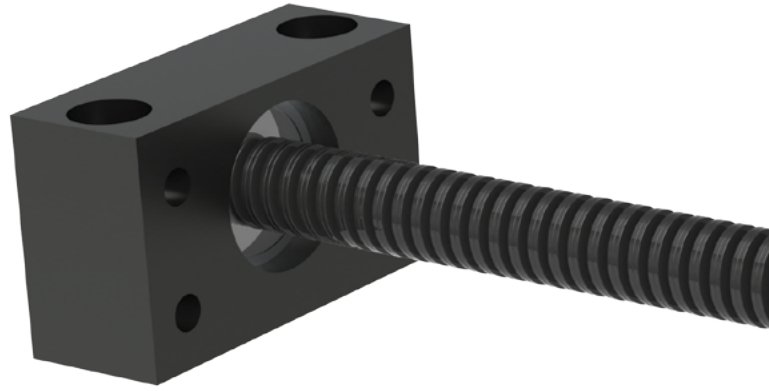

End Machining

HELIX ACME SCREW AND NUT ASSEMBLIES provide ease of application, as all that is required is installation. Helix assemblies offer turn key solutions that only require a power source (hand operation or motor). All of the elements are available for quick delivery from shelf stock. Component and assembly drawings are available from CAD drawings that can be configured online. Contact our sales engineers for assistance.

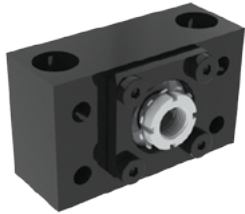

EZZE-MOUNT™ Bearing Mounts

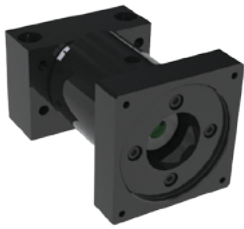



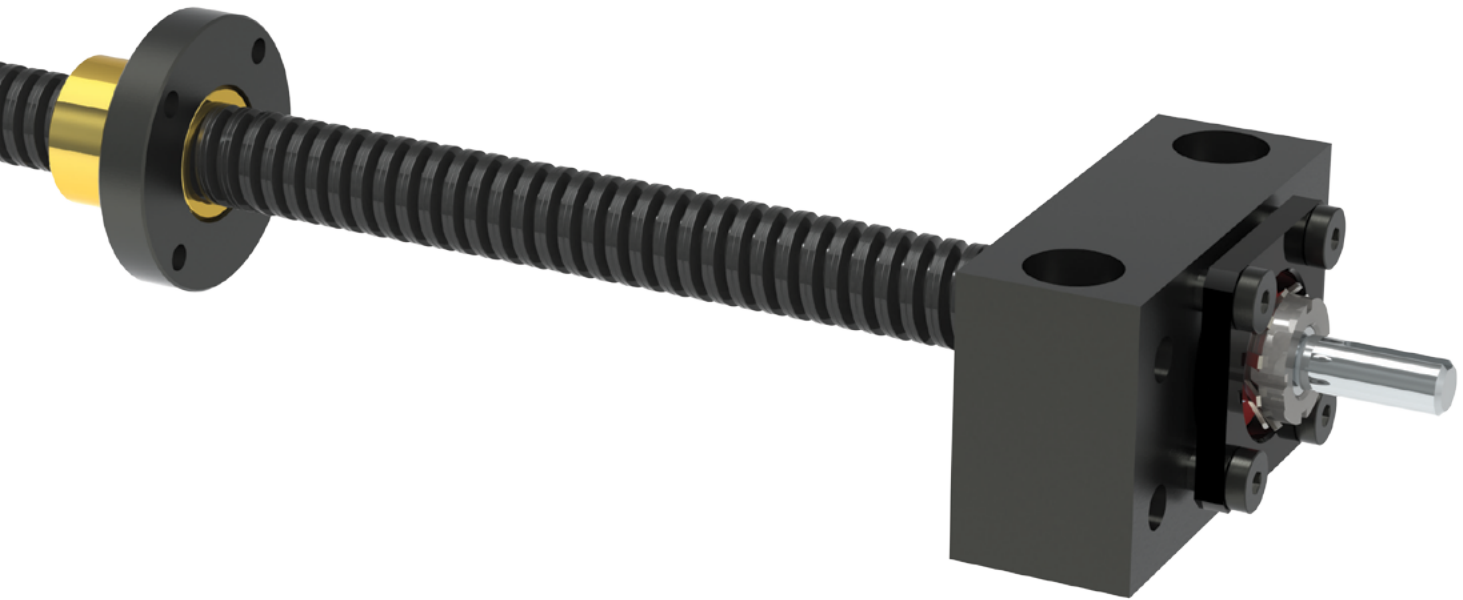

EZZE-MOUNT™ Motor Mounts





Helix Acme screws are used in a variety of life science applications

-  lubricants
p.26
-  twin-lead
screws
p.28
-  end
machining
p. 77
-  EZZE-MOUNT™
bearing supports
p. 77
-  screw
assemblies
p. 16

ACME SCREW AND NUT ASSEMBLIES UNIVERSAL MOUNTS

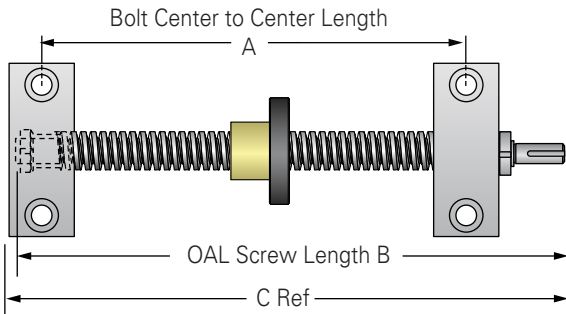
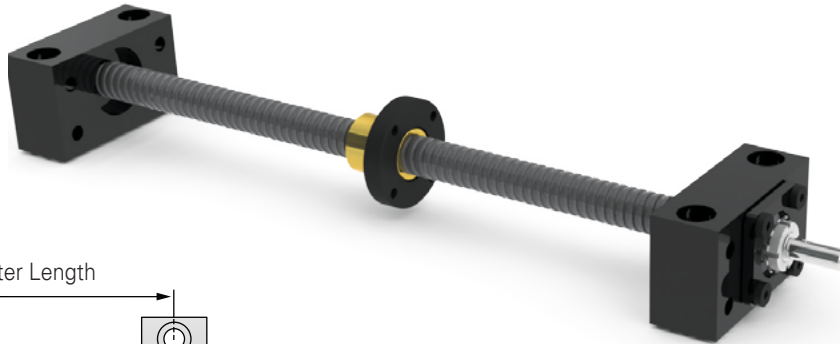

See page 27 to configure a part number.

NOTE: Dimensions reflect a 1/2" over travel at each end.
Add Travel to measurements below for total length.

Dia-Turns Per Inch of Travel	A (in)	B (in)	C (in)	Page
3/8 - 2	2.62	4.4	4.62	36
3/8 - 4	2.62	4.4	4.62	36
3/8 - 5	2.62	4.4	4.62	36
3/8 - 6	2.62	4.4	4.62	36
3/8 - 8	2.62	4.4	4.62	38
3/8 - 10	2.62	4.4	4.62	38
3/8 - 12	2.62	4.4	4.62	38
3/8 - 16	2.62	4.4	4.62	38
1/2 - 1	2.87	5.23	5.32	40
1/2 - 2	2.87	5.32	5.44	40
1/2 - 4	2.75	4.62	4.81	40
1/2 - 5	2.87	5.23	5.32	40
1/2 - 10	2.87	5.23	5.32	40
5/8 - 2 2/3	3.12	5.57	5.69	42
5/8 - 5	3.12	5.48	5.57	42
5/8 - 8	3.12	5.57	5.69	42
5/8 - 10	3.38	6.43	6.67	42
3/4 - 2	3.63	6.68	6.92	45
3/4 - 3	3.63	6.68	6.92	45

Dia-Turns Per Inch of Travel	A (in)	B (in)	C (in)	Page
3/4 - 5	3.63	6.68	6.92	44
3/4 - 6	3.63	6.68	6.92	44
3/4 - 10	3.63	6.60	7.13	44
7/8 - 6	3.88	6.85	7.38	44
1 - 1	4.22	8.14	8.25	46
1 - 2	4.18	7.45	7.84	46
1 - 4	4.18	7.45	7.84	46
1 - 5	4.18	7.45	7.84	48
1 - 6	4.18	7.45	7.84	48
1 - 10	4.22	8.14	8.25	48
1 1/8 - 5	4.28	8.14	8.25	50
1 1/4 - 4	4.47	8.39	8.50	50
1 1/4 - 5	4.69	8.84	9.14	50
1 1/2 - 2	5.24	9.84	10.10	52
1 1/2 - 2 2/3	5.24	9.39	9.69	52
1 1/2 - 4	5.24	9.84	10.10	52
1 1/2 - 5	5.24	9.84	10.10	52
1 1/2 - 10	5.24	9.84	10.10	52

NOTE: Larger screw sizes with EZZE-MOUNT™ bearing mounts are available. Consult factory engineers for details.

ACME SCREW AND NUT ASSEMBLIES
FLANGE MOUNTS, PILOT FACING IN

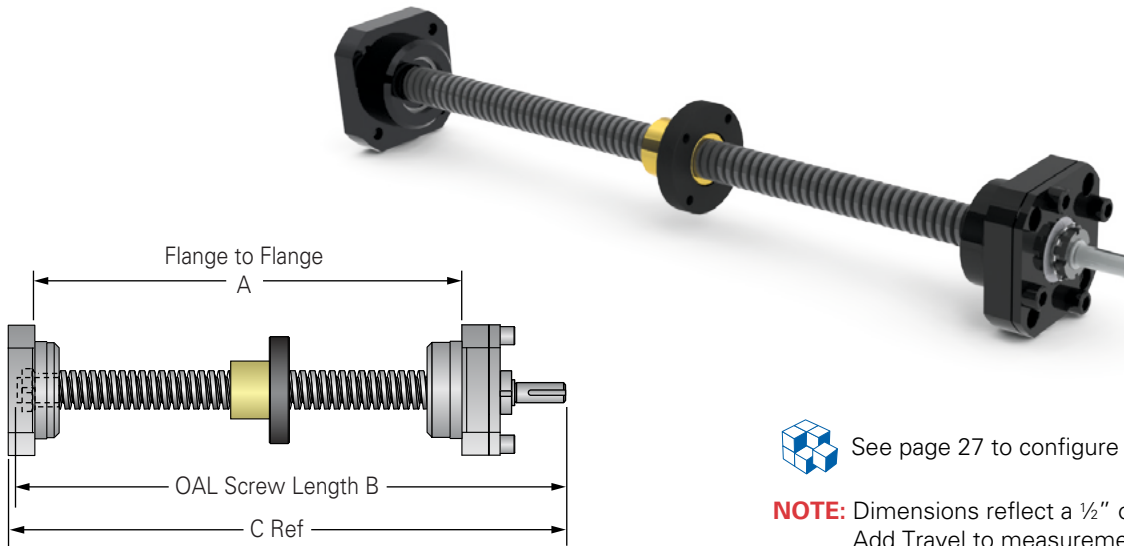

 See page 27 to configure a part number.

NOTE: Dimensions reflect a 1/2" over travel at each end. Add Travel to measurements below for total length.

Dia-Turns Per Inch of Travel	A (in)	B (in)	C (in)	Page
3/8 - 2	2.54	4.34	4.56	36
3/8 - 4	2.54	4.34	4.56	36
3/8 - 5	2.54	4.34	4.56	36
3/8 - 6	2.54	4.34	4.56	36
3/8 - 8	2.54	4.34	4.56	38
3/8 - 10	2.54	4.34	4.56	38
3/8 - 12	2.54	4.34	4.56	38
3/8 - 16	2.54	4.34	4.56	38
1/2 - 1	2.92	4.98	5.13	40
1/2 - 2	2.92	5.07	5.25	40
1/2 - 4	2.67	4.56	4.75	40
1/2 - 5	2.92	4.98	5.13	40
1/2 - 10	2.92	4.98	5.13	40
5/8 - 2 2/3	3.17	5.32	5.50	42
5/8 - 5	3.17	5.23	5.38	42
5/8 - 8	3.17	5.32	5.50	42
5/8 - 10	3.32	6.23	6.44	42
3/4 - 2	3.57	6.48	6.69	45
3/4 - 3	3.57	6.48	6.69	45

Dia-Turns Per Inch of Travel	A (in)	B (in)	C (in)	Page
3/4 - 5	3.57	6.48	6.69	44
3/4 - 6	3.57	6.48	6.69	44
3/4 - 10	3.78	6.79	7.00	44
7/8 - 6	4.03	7.04	7.25	44
1 - 1	4.27	7.79	8.00	46
1 - 2	4.09	7.27	7.47	46
1 - 4	4.09	7.27	7.47	46
1 - 5	4.09	7.27	7.47	48
1 - 6	4.09	7.27	7.47	48
1 - 10	4.27	7.79	8.00	48
1 1/8 - 5	4.27	7.79	8.00	50
1 1/4 - 4	4.52	8.04	8.25	50
1 1/4 - 5	4.72	8.57	8.87	50
1 1/2 - 2	5.26	9.57	9.83	52
1 1/2 - 2 2/3	5.27	9.12	9.42	52
1 1/2 - 4	5.26	9.57	9.83	52
1 1/2 - 5	5.26	9.57	9.83	52
1 1/2 - 10	5.26	9.57	9.83	52

NOTE: Larger screw sizes with EZZE-MOUNT™ bearing mounts are available. Consult factory engineers for details.

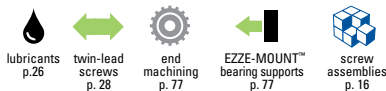

ACME SCREW AND NUT ASSEMBLIES FLANGE MOUNTS, PILOT FACING OUT

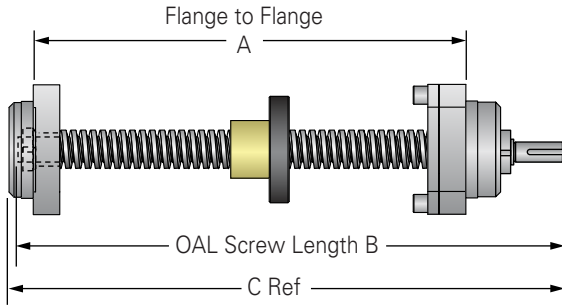
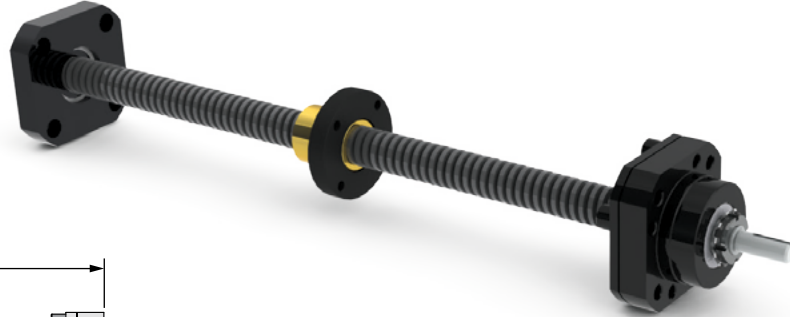

See page 27 to configure a part number.

NOTE: Dimensions reflect a 1/2" over travel at each end.
Add Travel to measurements below for total length.

Dia-Turns Per Inch of Travel	A (in)	B (in)	C (in)	Page
3/8 - 2	2.8	4.34	4.56	36
3/8 - 4	2.8	4.34	4.56	36
3/8 - 5	2.8	4.34	4.56	36
3/8 - 6	2.8	4.34	4.56	36
3/8 - 8	2.8	4.34	4.56	38
3/8 - 10	2.8	4.34	4.56	38
3/8 - 12	2.8	4.34	4.56	38
3/8 - 16	2.8	4.34	4.56	38
1/2 - 1	2.95	4.98	5.13	40
1/2 - 2	2.95	5.07	5.25	40
1/2 - 4	2.93	4.56	4.75	40
1/2 - 5	2.95	4.98	5.13	40
1/2 - 10	2.95	4.98	5.13	40
5/8 - 2 2/3	3.2	5.32	5.50	42
5/8 - 5	3.2	5.23	5.38	42
5/8 - 8	3.2	5.32	5.50	42
5/8 - 10	3.44	6.23	6.44	42
3/4 - 2	3.69	6.48	6.69	45
3/4 - 3	3.69	6.48	6.69	45

Dia-Turns Per Inch of Travel	A (in)	B (in)	C (in)	Page
3/4 - 5	3.69	6.48	6.69	44
3/4 - 6	3.69	6.48	6.69	44
3/4 - 10	3.72	6.79	7.00	44
7/8 - 6	3.97	7.04	7.25	44
1 - 1	4.22	7.79	8.00	46
1 - 2	4.2	7.27	7.47	46
1 - 4	4.2	7.27	7.47	46
1 - 5	4.2	7.27	7.47	48
1 - 6	4.2	7.27	7.47	48
1 - 10	4.22	7.79	8.00	48
1 1/8 - 5	4.22	7.79	8.00	50
1 1/4 - 4	4.47	8.04	8.25	50
1 1/4 - 5	4.85	8.57	8.87	50
1 1/2 - 2	5.41	9.57	9.83	52
1 1/2 - 2 2/3	5.4	9.12	9.42	52
1 1/2 - 4	5.41	9.57	9.83	52
1 1/2 - 5	5.41	9.57	9.83	52
1 1/2 - 10	5.41	9.57	9.83	52

NOTE: Larger screw sizes with EZZE-MOUNT™ bearing mounts are available. Consult factory engineers for details.

* Indicates modified Type 3 end machining required
** HO65 handwheel has the same outer dimensions as HO64 but different bore

ASSEMBLIES WITH HANDWHEEL
UNIVERSAL MOUNTS

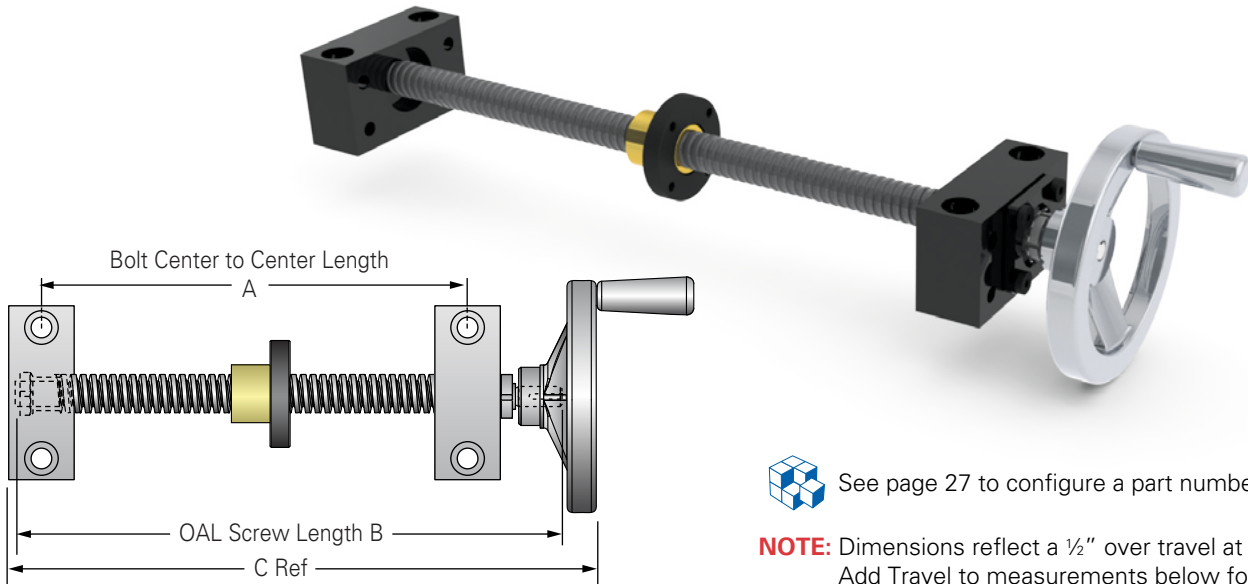

 See page 27 to configure a part number.

NOTE: Dimensions reflect a 1/2" over travel at each end. Add Travel to measurements below for total length.

Dia-Turns Per Inch of Travel	A (in)	B (in)	C (in)	Size	Part No.	Page
5/8 - 10	3.38	6.43	7.17	4"	H043*	42
3/4 - 2	3.63	6.68	7.42	4"	H043*	44
3/4 - 3	3.63	6.68	7.42	4"	H043*	44
3/4 - 5	3.63	6.68	7.42	4"	H043*	44
3/4 - 6	3.63	6.68	7.42	4"	H043*	44
3/4 - 10	3.63	6.60	7.31	4"	H044	44
7/8 - 6	3.88	6.85	7.81	6"	H064	44
1 - 1	4.22	8.14	9.00	6"	H065**	46
1 - 2	4.18	7.45	8.59	6"	H064	46
1 - 4	4.18	7.45	8.59	6"	H064	46
1 - 5	4.18	7.45	8.59	6"	H064	48

Dia-Turns Per Inch of Travel	A (in)	B (in)	C (in)	Size	Part No.	Page
1 - 6	4.18	7.45	8.59	6"	H064	48
1 - 10	4.22	8.14	9.00	6"	H065**	48
1 1/8 - 5	4.22	8.14	9.00	6"	H065**	50
1 1/4 - 4	4.47	8.39	9.25	6"	H065**	50
1 1/4 - 5	4.69	8.14	9.89	8"	H086	50
1 1/2 - 2	5.24	9.84	10.85	8"	H088	52
1 1/2 - 2 2/3	5.24	9.39	10.44	8"	H086	52
1 1/2 - 4	5.24	9.84	10.85	8"	H088	52
1 1/2 - 5	5.24	9.84	10.85	8"	H088	52
1 1/2 - 10	5.24	9.84	10.85	8"	H088	52

NOTE: Larger screw sizes with EZZE-MOUNT™ bearing mounts are available. Consult factory engineers for details.

* Indicates modified Type 3 end machining required

** H065 handwheel has the same outer dimensions as H064 but different bore



ASSEMBLIES WITH HANDWHEEL FLANGE MOUNTS, FACING IN

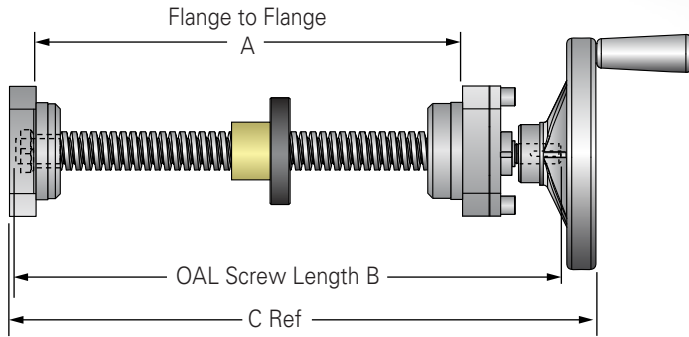
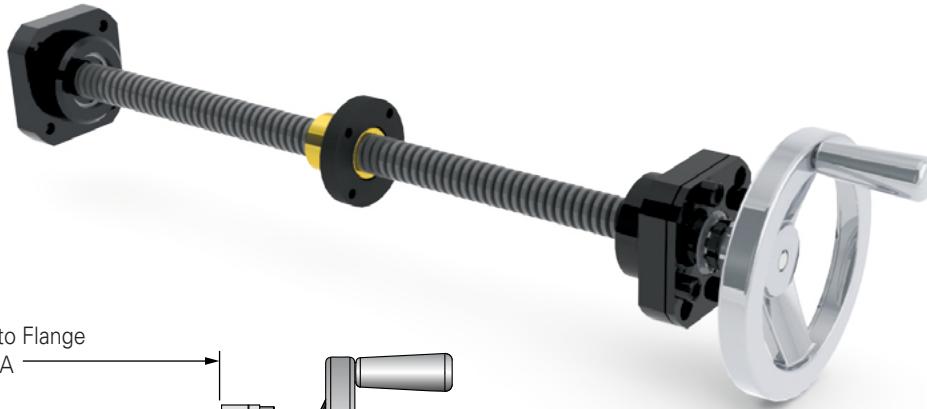

See page 27 to configure a part number.

NOTE: Dimensions reflect a 1/2" over travel at each end. Add Travel to measurements below for total length.

Dia-Turns Per Inch of Travel	A (in)	B (in)	C (in)	Size	Part No.	Page
3/4 - 2	3.57	6.48	6.24	4"	H043*	44
3/4 - 3	3.57	6.48	6.24	4"	H043*	44
3/4 - 5	3.57	6.48	6.24	4"	H043*	44
3/4 - 6	3.57	6.48	6.24	4"	H043*	44
3/4 - 10	3.78	6.79	7.55	4"	H044	44
7/8 - 6	4.03	7.04	8.17	6"	H064	44
1 - 1	4.27	7.79	8.92	6"	H065**	46
1 - 2	4.09	7.27	8.39	6"	H064	46
1 - 4	4.09	7.27	8.39	6"	H064	46
1 - 5	4.09	7.27	8.39	6"	H064	48

Dia-Turns Per Inch of Travel	A (in)	B (in)	C (in)	Size	Part No.	Page
1 - 6	4.09	7.27	8.39	6"	H064	48
1 - 10	4.27	7.79	8.92	6"	H065	48
1 1/8 - 5	4.27	7.79	8.92	6"	H065**	50
1 1/4 - 4	4.52	8.04	9.17	6"	H065**	50
1 1/4 - 5	4.72	8.57	9.92	8"	H086	50
1 1/2 - 2	5.26	9.57	10.88	8"	H088	52
1 1/2 - 2 2/3	5.27	9.12	10.47	8"	H086	52
1 1/2 - 4	5.26	9.57	10.88	8"	H088	52
1 1/2 - 5	5.26	9.57	10.88	8"	H088	52
1 1/2 - 10	5.26	9.57	10.88	8"	H088	52

NOTE: Larger screw sizes with EZZE-MOUNT™ bearing mounts are available. Consult factory engineers for details.

* Indicates modified Type 3 end machining required
 ** HO65 handwheel has the same outer dimensions as HO64 but different bore



ASSEMBLIES WITH HANDWHEEL
FLANGE MOUNTS, FACING OUT

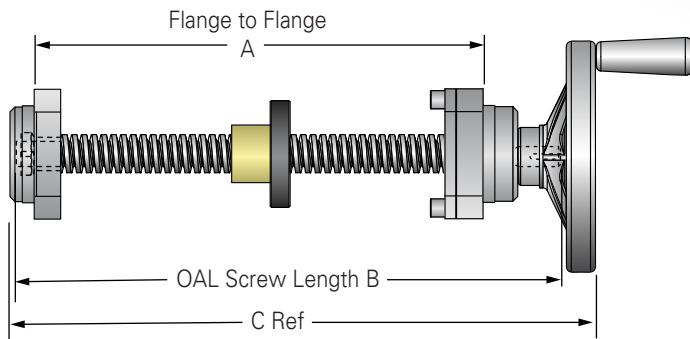
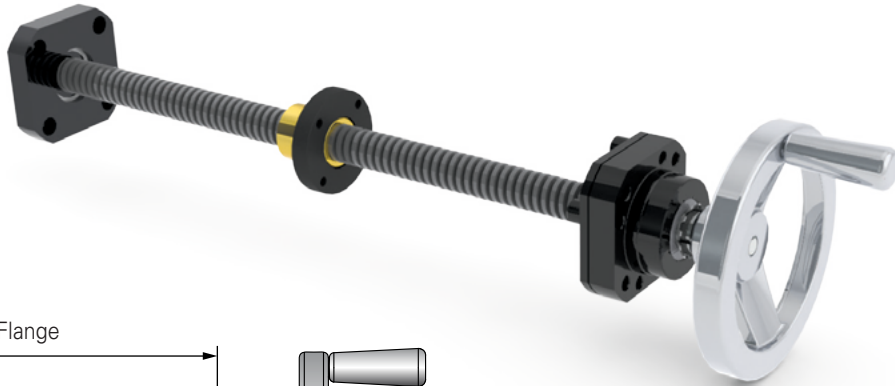

See page 27 to configure a part number.

NOTE: Dimensions reflect a 1/2" over travel at each end. Add Travel to measurements below for total length.

Dia-Turns Per Inch of Travel	A (in)	B (in)	C (in)	Size	Part No.	Page
5/8 - 10	6.23	3.44	6.99	4"	H043*	42
3/4 - 2	6.48	3.69	7.24	4"	H043*	44
3/4 - 3	6.48	3.69	7.24	4"	H043*	44
3/4 - 5	6.48	3.69	7.24	4"	H043*	44
3/4 - 6	6.48	3.69	7.24	4"	H043*	44
3/4 - 10	6.79	3.72	7.55	4"	H044	44
7/8 - 6	7.04	3.97	8.17	6"	H064	44
1 - 1	7.79	4.22	8.92	6"	H065**	46
1 - 2	7.27	4.20	8.39	6"	H064	46
1 - 4	7.27	4.20	8.39	6"	H064	46
1 - 5	7.27	4.20	8.39	6"	H064	48

Dia-Turns Per Inch of Travel	A (in)	B (in)	C (in)	Size	Part No.	Page
1 - 6	7.27	4.20	8.39	6"	H064	48
1 - 10	7.79	4.22	8.92	6"	H065**	48
1 1/8 - 5	7.79	4.22	8.92	6"	H065**	50
1 1/4 - 4	8.04	4.47	9.17	6"	H065**	50
1 1/4 - 5	8.57	4.85	9.92	8"	H086	50
1 1/2 - 2	9.57	5.41	10.88	8"	H088	52
1 1/2 - 2 2/3	9.12	5.4	10.47	8"	H086	52
1 1/2 - 4	9.57	5.41	10.88	8"	H088	52
1 1/2 - 5	9.57	5.41	10.88	8"	H088	52
1 1/2 - 10	9.57	5.41	10.88	8"	H088	52

NOTE: Larger screw sizes with EZZE-MOUNT™ bearing mounts are available. Consult factory engineers for details.

* Indicates modified Type 3 end machining required

** H065 handwheel has the same outer dimensions as H064 but different bore

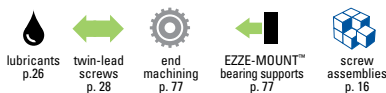

ASSEMBLIES WITH MOTOR MOUNTS

UNIVERSAL MOUNTS

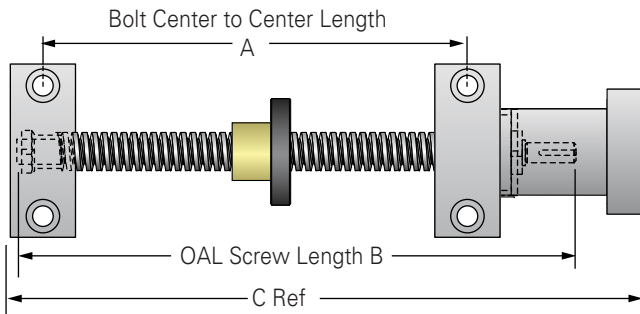
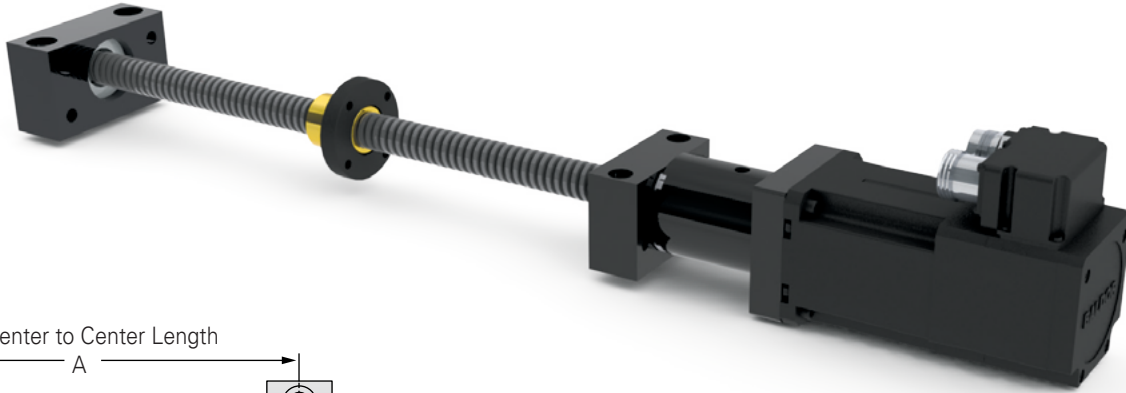

See page 27 to configure a part number.

NOTE: Dimensions reflect a 1/2" over travel at each end.
Add Travel to measurements below for total length.

Dia-Turns Per Inch of Travel	A (in)	B (in)	C (in)	Motor Mount	Page
1/2 - 1	2.87	5.23	7.04	EZM-1009-23	40
1/2 - 2	2.87	5.32	7.04	EZM-3010-23	40
1/2 - 4	2.75	4.62	6.16	EZM-1008-17	40
1/2 - 5	2.87	5.23	7.04	EZM-1009-23	40
1/2 - 10	2.87	5.23	7.04	EZM-1009-23	40
5/8 - 2 2/3	3.12	5.57	7.29	EZM-3010-23	42
5/8 - 5	3.12	5.48	7.29	EZM-1009-23	42
5/8 - 8	3.12	5.57	7.29	EZM-3010-23	42
5/8 - 10	3.38	6.43	8.3	EZM-3012-23	42
3/4 - 2	3.63	6.68	8.55	EZM-3012-23	44
3/4 - 3	3.63	6.68	8.55	EZM-3012-23	44
3/4 - 5	3.63	6.68	8.55	EZM-3012-23	44
3/4 - 6	3.63	6.68	8.55	EZM-3012-23	44
3/4 - 10	3.63	6.60	8.76	EZM-3015-34	44
7/8 - 6	3.88	6.85	9.01	EZM-3015-34	44

Dia-Turns Per Inch of Travel	A (in)	B (in)	C (in)	Motor Mount	Page
1 - 1	4.22	8.14	10.18	EZM-2020-34	46
1 - 2	4.18	7.45	9.75	EZM-3017-34	46
1 - 4	4.18	7.45	9.75	EZM-3017-34	46
1 - 5	4.18	7.45	9.75	EZM-3017-34	48
1 - 6	4.18	7.45	9.75	EZM-3017-34	48
1 - 10	4.22	8.14	10.18	EZM-2020-34	48
1 1/8 - 5	4.28	8.14	10.18	EZM-2020-34	50
1 1/4 - 4	4.47	8.39	10.43	EZM-2020-34	50
1 1/4 - 5	4.69	8.84	11.13	EZM-3025-34	50
1 1/2 - 2	5.24	9.84	12.21	EZM-2030-34	52
1 1/2 - 2 2/3	5.24	9.39	11.68	EZM-3025-34	52
1 1/2 - 4	5.24	9.84	12.21	EZM-2030-34	52
1 1/2 - 5	5.24	9.84	12.21	EZM-2030-34	52
1 1/2 - 10	5.24	9.84	12.21	EZM-2030-34	52

NOTE: Larger screw sizes with EZZE-MOUNT™ bearing mounts are available. Consult factory engineers for details.

ASSEMBLIES WITH MOTOR MOUNTS
FLANGE MOUNTS, FACING IN

ACME SCREW ASSEMBLIES

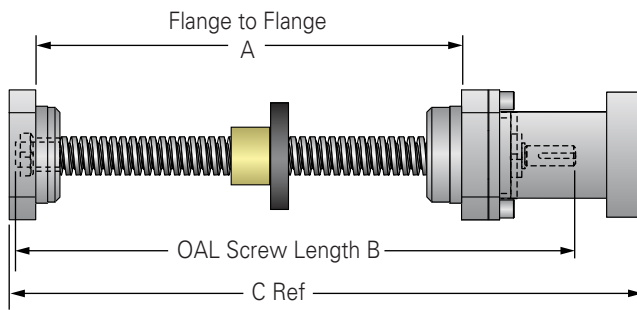
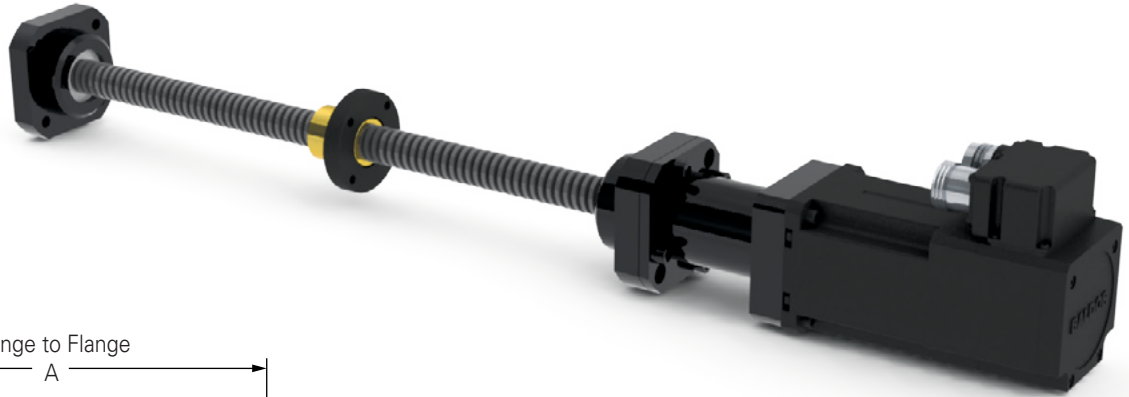

See page 27 to configure a part number.

NOTE: Dimensions reflect a 1/2" over travel at each end. Add Travel to measurements below for total length.

Dia-Turns Per Inch of Travel	A (in)	B (in)	C (in)	Motor Mount	Page
1/2 - 1	2.92	4.98	6.89	EZF-1009-23	40
1/2 - 2	2.92	5.07	6.89	EZF-3010-23	40
1/2 - 4	2.67	4.56	6.11	EZF-1008-17	40
1/2 - 5	2.92	4.98	6.89	EZF-1009-23	40
1/2 - 10	2.92	4.98	6.89	EZF-1009-23	40
5/8 - 2 2/3	3.17	5.32	7.14	EZF-3010-23	42
5/8 - 5	3.17	5.23	7.14	EZF-1009-23	42
5/8 - 8	3.17	5.32	7.14	EZF-3010-23	42
5/8 - 10	3.32	6.23	6.62	EZF-3012-23	42
3/4 - 2	3.57	6.48	6.87	EZF-3012-23	44
3/4 - 3	3.57	6.48	6.87	EZF-3012-23	44
3/4 - 5	3.57	6.48	6.87	EZF-3012-23	44
3/4 - 6	3.57	6.48	6.87	EZF-3012-23	44
3/4 - 10	3.78	6.79	9.01	EZF-3015-34	44
7/8 - 6	4.03	7.04	9.26	EZF-3015-34	44

Dia-Turns Per Inch of Travel	A (in)	B (in)	C (in)	Motor Mount	Page
1 - 1	4.27	7.79	9.94	EZF-2020-34	46
1 - 2	4.09	7.27	9.4	EZF-3017-34	46
1 - 4	4.09	7.27	9.4	EZF-3017-34	46
1 - 5	4.09	7.27	9.4	EZF-3017-34	48
1 - 6	4.09	7.27	9.4	EZF-3017-34	48
1 - 10	4.27	7.79	9.94	EZF-2020-34	48
1 1/8 - 5	4.27	7.79	9.94	EZF-2020-34	50
1 1/4 - 4	4.52	8.04	10.19	EZF-2020-34	50
1 1/4 - 5	4.72	8.57	10.87	EZF-3025-34	50
1 1/2 - 2	5.26	9.57	11.96	EZF-2030-34	52
1 1/2 - 2 2/3	5.27	9.12	11.42	EZF-3025-34	52
1 1/2 - 4	5.26	9.57	11.96	EZF-2030-34	52
1 1/2 - 5	5.26	9.57	11.96	EZF-2030-34	52
1 1/2 - 10	5.26	9.57	11.96	EZF-2030-34	52

NOTE: Larger screw sizes with EZZE-MOUNT™ bearing mounts are available. Consult factory engineers for details.

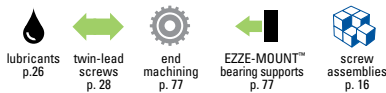

ACME SCREW ASSEMBLIES Lubricants

PROLONG ACME SCREW ASSEMBLY RELIABILITY AND LIFE

Proper lubrication is the key to continued performance and reliability of Acme screw assemblies. Use E-100 spray and PAG-1 grease lubricants to maximize life of your Acme screw assembly.



BENEFITS

- Shear Stability
- High Temperature Resistant
- Corrosion Protection
- Separation Resistant
- Extreme Pressure Properties
- Shelf Stable
- Water Resistant

Product Name	NLGI Grade Number	Penetration (worked)	Dropping Point	Gelling Agent	Net Contents per Unit	cst @40°C	Oil Viscosity		Temp. Range	Quantity	Part No.	Total Weight
							cst @100°C					
PAG-1 Grease	2	285	550°C	Calcium	1 lb	96	113	15°F to 400°F	1	NLU-1001	1.25 lb	
									Case of 12	NLU-2001	18 lb	
E-100 Spray	2	285	550°C	Calcium	12 oz	96	113	15°F to 400°F	1	NLU-1002	1 lb	
									Case of 12	NLU-2002	15 lb	

Greases for All Purpose Applications

Part Number	Volume	Temp Range (C)
APG-2G	2 gram Packet	-54 to 125
APG-50G	50 gram Jar	



Applications: A lithium soap thickened, light viscosity, synthetic hydrocarbon grease for instruments and bearings. Excellent for wide temperature performance.

Greases for Medical Grade Applications

Part Number	Volume	Temp Range (C)
MLG-4G	4 gram Packet	-65 to 250
MLG-100G	100 gram Jar	



Applications: A PTFE thickened, high viscosity, completely fluorinated grease for use in high temperature applications exposed to aggressive chemicals. It possesses excellent thermo-oxidative stability and low vapor pressure characteristics.

Greases for Semiconductor/Static Dissipative Applications

Part Number	Volume	Temp Range (C)
SSG-3.5G	3.5 gram Pipette	-65 to 250
SSG-50G	50 gram Jar	



Applications: A PTFE thickened, heavy viscosity. Perfluoropolyether grease intended for high vacuum and clean room applications, spacecraft and semiconductor manufacturing equipment. Benefits include very low vapor pressure.

Greases for Military and Aerospace Applications

Part Number	Volume	Temp Range (C)
MAG-4G	4 gram Packet	-65 to 200
MAG-100G	100 gram Jar	



Applications: A PTFE Thickened, medium viscosity, completely fluorinated grease intended for components where wide temperature and low torque are critical. Meets MIL-RRF-27617F, Type IV specifications for aircraft ANO instrument; fuel and oxidizer resistant.

ACME SCREW ASSEMBLIES

Reference Number System



ACME SCREW
Thread Form Codes

- 025 = 1/4"-3
- 024 = 1/4"-4
- 026 = 1/4"-16
- 020 = 1/4"-20
- 022 = 5/16"-2
- 028 = 5/16"-4
- 031 = 3/8"-1
- 037 = 3/8"-2
- 034 = 3/8"-4
- 035 = 3/8"-5
- 036 = 3/8"-6
- 038 = 3/8"-8
- 030 = 3/8"-10
- 032 = 3/8"-12
- 033 = 3/8"-16
- 051 = 1/2"-1
- 052 = 1/2"-2
- 054 = 1/2"-4
- 055 = 1/2"-5
- 050 = 1/2"-10
- 063 = 5/8"- 2-2/3
- 065 = 5/8"- 5
- 062 = 5/8"- 5 (2)
- 068 = 5/8"- 8
- 060 = 5/8"- 10
- 072 = 3/4"- 2
- 073 = 3/4"- 3
- 075 = 3/4"- 5
- 076 = 3/4"- 6
- 070 = 3/4"- 10
- 086 = 7/8"- 6
- 111 = 1"- 1
- 112 = 1"- 2
- 104 = 1"- 4
- 105 = 1"- 5
- 106 = 1"- 6
- 110 = 1"- 10
- 115 = 1-1/8"- 5
- 124 = 1-1/4"- 4
- 125 = 1-1/4"- 5
- 152 = 1-1/2"- 2
- 153 = 1-1/2"- 2-2/3
- 154 = 1-1/2"- 4
- 155 = 1-1/2"- 5
- 150 = 1-1/2"- 10
- 174 = 1-3/4"- 4
- 202 = 2"- 2
- 204 = 2"- 4
- 205 = 2"- 5
- 222 = 2-1/4"- 2
- 224 = 2-1/4"- 4
- 252 = 2-1/2"- 2
- 253 = 2-1/2"- 3
- 254 = 2-1/2"- 4
- 302 = 3"- 2

MATERIAL

- R A**
- R = Right Hand Thread
L = Left Hand Thread
- A = Alloy Steel, Rolled
B = Alloy Steel, Milled
C = Alloy Steel, Ground
S = Stainless, Rolled
T = Stainless, Milled
U = Stainless, Ground
- Note:** Not all materials are available for all sizes.

FIRST END CONFIGURATION

- Note:** Both Ends must be specified.
- Single Bearing Supports are used in conjunction with Type 1N end machining.
- Double Bearing Supports are used in conjunction with Type 3K, 3L, or 3N end machining.
- Flanged Fixed Bearing Mounts are used in conjunction with Type 5 end machining.

EZZE-MOUNT™ End Machining

(see pages 66-68)

- 1 = Type 1 3 = Type 3
2 = Type 2 4 = Type 4
5 = Type 5

B = Universal Double Bearing Support End Cap Facing Screw Thread

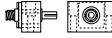

C = Universal Single Bearing Support

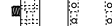

D = Flanged Single Bearing Support Flange Facing Screw Thread



E = Universal Double Bearing Support End Cap Facing Away From Screw Thread

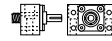

F = Flanged Double Bearing Support Flange Facing Screw Thread

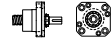

G = Flanged Single Bearing Support Flange Facing Away From Screw Thread

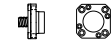

H = Flanged Double Bearing Support Flange Facing Away From Screw Thread

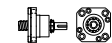

R = Flanged Fixed Bearing Support Flange Facing Screw Thread



MODIFIER LIST

- S or M Required
- S = Standard, no additional description required
M = Modified, additional description required
T = PTFE coating

ACME NUT

Nut will be installed with flange or threaded end toward first end designation. (000000 = No Nut)

OVERALL LENGTH (OAL)

Length in inches, 2 place decimal

SECOND END CONFIGURATION

Refer to the First End Configuration section
Note: Both Ends must be specified.

Shaft Extension

(see pages 66-68)

- N** = No Shaft
- Q** = Handwheel
- K** = Shaft Extension with Keyway
- L** = Shaft Extension without Keyway

U = Universal Double Bearing Support with Motor Mount



V = Flanged Fixed Bearing Support Flange Facing Away From Screw Thread

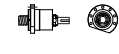

Y = Flanged Double Bearing Support with Motor Mount



00 = No End Machining (Screw will be cut to desired length).

XX = Custom Machining (Print or specified data must be provided)

F, V or Z are Optional
F = Round Flange
V = Single Acme Flange (see pg.10)
Z = Two Acme Flange (see pg.10)

TWIN-LEAD SCREW ASSEMBLIES ↔
REFERENCE NUMBER SYSTEM

105 - TA / EK / 4N / 33.50 / 16.75 / 16.75 / 80105A / 20105A / FS

TWIN-LEAD ACME SCREW

Thread Form Codes

Part	Dia. - Lead	Part	Dia. - Lead
032	= 3/8"-12*	104	= 1"-4
050	= 1/2"-10	105	= 1"-5*
063	= 5/8"-2 2/3	106	= 1"-6
065	= 5/8"-5	110	= 1"-10*
068	= 5/8"-8*	124	= 1-1/4"-4
073	= 3/4"-3	125	= 1-1/4"-5*
075	= 3/4"-5*	154	= 1-1/2"-4*
076	= 3/4"-6	155	= 1-1/2"-5
070	= 3/4"-10	150	= 1-1/2"-10
086	= 7/8"-6	174	= 1-3/4"-4
111	= 1"-1	204	= 2"-4*

* These twin-lead screws are stocked without end machining

MATERIAL

T A

- T = Twin Lead
- A = Alloy Steel, Rolled
- B = Alloy Steel, Milled
- C = Alloy Steel, Ground
- S = Stainless, Rolled
- T = Stainless, Milled
- U = Stainless, Ground

Note: Not all materials are available for all sizes.

FIRST END CONFIGURATION (LH thread)

Note: Both Ends must be specified.

Single Bearing Supports are used in conjunction with Type 1N end machining.

Double Bearing Supports are used in conjunction with Type 3K, 3L, or 3N end machining.

Flanged Fixed Bearing Mounts are used in conjunction with Type 5 end machining.

SECOND END CONFIGURATION (RH thread)

Refer to the First End Configuration section on the Left.

Note: Both Ends must be specified.

OVER-ALL-LENGTH (OAL)

Length in inches, 2 place decimal

LEFT HAND THREAD

Length in inches, 2 place decimal

Note: See figure on page 32

RIGHT HAND THREAD

Length in inches, 2 place decimal

Note: See figure on page 32

LEFT HAND ACME NUT

000000 = No Nut

RIGHT HAND ACME NUT

000000 = No Nut

Note: To Select the Nut Direction After Nut Part # Add

A = Nut Thread or Flange installed toward center of screw

B = Nut Thread or Flange installed toward end of screw

MODIFIER LIST

- F = Round Flange
- S or M Required
- S = Standard, no additional description required
- M = Modified, additional description required
- T = PTFE coating

EZZE-MOUNT™ / End Machining
 (see pages 82-85)

- 1 = Type 1
- 2 = Type 2
- 3 = Type 3
- 4 = Type 4
- 5 = Type 5

EK

EK = Universal Double Bearing Support, with Keyway

Shaft Extension
 (see pages 82-84)

- K = Shaft Extension with Keyway
- L = Shaft Extension without Keyway
- N = No Shaft
- Q = Handwheel

B = Universal Double Bearing Support End Cap Facing Screw Thread

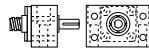

C = Universal Single Bearing Support



D = Flanged Single Bearing Support Flange Facing Screw Thread



E = Universal Double Bearing Support End Cap Facing Away From Screw Thread

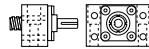

F = Flanged Double Bearing Support Flange Facing Screw Thread

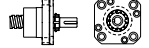

G = Flanged Single Bearing Support Flange Facing Away From Screw Thread



H = Flanged Double Bearing Support Flange Facing Away From Screw Thread

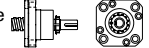

R = Flanged Fixed Bearing Support Flange Facing Screw Thread

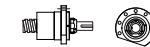

U = Universal Double Bearing Support with Motor Mount



V = Flanged Fixed Bearing Support Flange Facing Away From Screw Thread

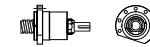

Y = Flanged Double Bearing Support with Motor Mount

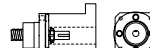

00 = No End Machining (Screw will be cut to desired length).

XX = Custom Machining (Print or specified data must be provided).

1/4 inch diameter
5/16 inch diameter

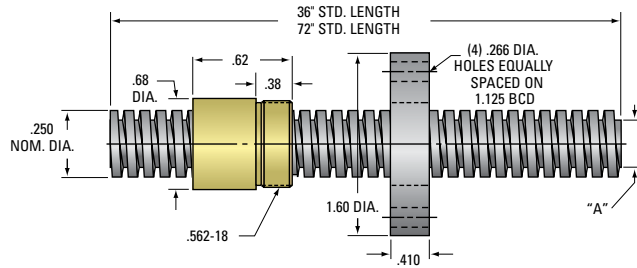

1/4" ACME THREAD
 Lead Accuracy 0.0003 in/in

Screw Size	ACME SCREW												
	Part Number RH	Part Number LH	Length (in)	Material	Lead (in)	Pitch (in)	Starts	Threads per in	Lash (max axial)	"A" Dia (in)	Wt. (lb/ft)	Thread Code	Form
1/4" - 3	11025	—	36	4140	.333	.083	4	12	.005	.192	.13	025	Stub
	91025	—	36	SS	.333	.083	4	12	.005	.192	.13	025	Stub
	12025	—	72	4140	.333	.083	4	12	.005	.192	.13	025	Stub
	92025	—	72	SS	.333	.083	4	12	.005	.192	.13	025	Stub
1/4" - 4	91024	—	36	SS	.250	.062	4	16	.007	.162	.13	024	2C
	92024	—	72	SS	.250	.062	4	16	.007	.162	.13	024	2C
1/4" - 20	91020	—	36	SS	.050	.050	4	16	.006	.175	.13	020	2C
	92020	—	72	SS	.050	.050	4	16	.006	.175	.13	020	2C
5/16" - 2	91022	—	36	SS	.500	.125	4	8	.008	.216	.18	022	Stub
	92022	—	72	SS	.500	.125	4	8	.008	.216	.18	022	Stub
5/16" - 4	11028	—	36	4140	.250	.125	2	8	.008	.216	.18	028	Stub
	91028	—	36	SS	.250	.125	2	8	.008	.216	.18	028	Stub

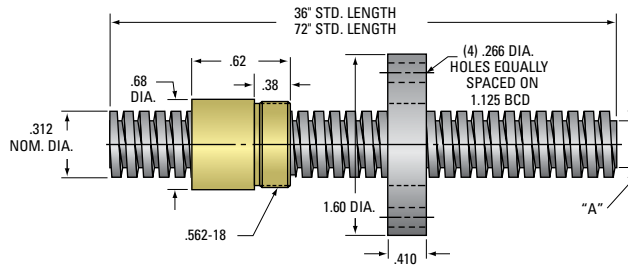

5/16" ACME THREAD
Lead Accuracy 0.0003 in/in

	BRONZE NUT							PLASTIC NUT					FLANGE				
	Part Number RH	LH	% Efficiency	Torque* (in lb)	Load Capacity (lb) Dynamic	Static	Wt. (lb)	Part Number RH	LH	% Efficiency	Torque* (in lb)	Load Capacity (lb) Dynamic	Static	Wt. (lb)	Std.	No-Lash™	Wt. (lb)
	20025	—	73	.073	312	1,000	.13	30025	—	79	.067	156	156	.06	70160	73160	.23
	20025	—	73	.073	312	1,000	.13	30025	—	79	.067	156	156	.06	70160	73160	.23
	20025	—	73	.073	312	1,000	.13	30025	—	79	.067	156	156	.06	70160	73160	.23
	20025	—	73	.073	312	1,000	.13	30025	—	79	.067	156	156	.06	70160	73160	.23
	20024	—	71	.056	312	1,000	.13	30024	—	75	.053	156	156	.06	70160	73160	.23
	20024	—	71	.056	312	1,000	.13	30024	—	75	.053	156	156	.06	70160	73160	.23
	20020	—	36	.022	312	1,000	.13	30020	—	40	.020	156	156	.06	70160	73160	.23
	20020	—	36	.022	312	1,000	.13	30020	—	40	.020	156	156	.06	70160	73160	.23
	—	—	—	—	—	—	—	30022	—	81	.099	205	205	.01	70160	73160	.23
	—	—	—	—	—	—	—	30022	—	81	.099	205	205	.01	70160	73160	.23
	20028	—	67	.059	510	1,625	.05	30028	—	73	.054	205	205	.01	70160	73160	.23
	20028	—	67	.059	510	1,625	.05	30028	—	73	.054	205	205	.01	70160	73160	.23

* Torque required to raise 1 lb.

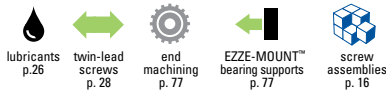

3/8 inch diameter

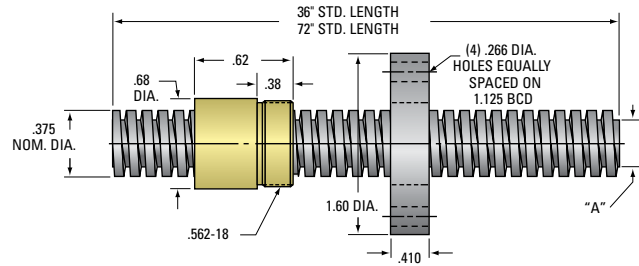

3/8" ACME THREAD
Lead Accuracy 0.0003 in/in

ACME SCREW													
Screw Size	Part Number		Length (in)	Material	Lead (in)	Pitch (in)	Starts	Threads per in	Lash (max axial)	"A" Dia (in)	Wt. (lb/ft)	Thread Code	Form
	RH	LH											
3/8" - 1	91031	—	36	SS	1.000	.200	5	5	.010	.238	.29	031	Fast
	92031	—	72	SS	1.000	.200	5	5	.010	.238	.29	031	Fast
3/8" - 2	11037	—	36	4140	.500	.125	4	8	.009	.278	.29	037	Stub
	91037	—	36	SS	.500	.125	4	8	.009	.278	.29	037	Stub
	12037	—	72	4140	.500	.125	4	8	.009	.278	.29	037	Stub
	92037	—	72	SS	.500	.125	4	8	.009	.278	.29	037	Stub
3/8" - 4	11034	—	36	4140	.250	.125	2	8	.009	.278	.29	034	Stub
	91034	—	36	SS	.250	.125	2	8	.009	.278	.29	034	Stub
	12034	—	72	4140	.250	.125	2	8	.009	.278	.29	034	Stub
	92034	—	72	SS	.250	.125	2	8	.009	.278	.29	034	Stub
3/8" - 5	11035	—	36	4140	.200	.100	2	10	.008	.282	.29	035	Stub
	91035	—	36	SS	.200	.100	2	10	.008	.282	.29	035	Stub
	12035	—	72	4140	.200	.100	2	10	.008	.282	.29	035	Stub
	92035	—	72	SS	.200	.100	2	10	.008	.282	.29	035	Stub
3/8" - 6	11036	51036	36	4140	.166	.083	2	12	.006	.263	.29	036	2C
	91036	—	36	SS	.166	.083	2	12	.006	.263	.29	036	2C
	12036	52036	72	4140	.166	.083	2	12	.006	.263	.29	036	2C
	92036	—	72	SS	.166	.083	2	12	.006	.263	.29	036	2C

3/8" ACME THREAD SCREW ASSEMBLIES
CONTINUED ON NEXT PAGE

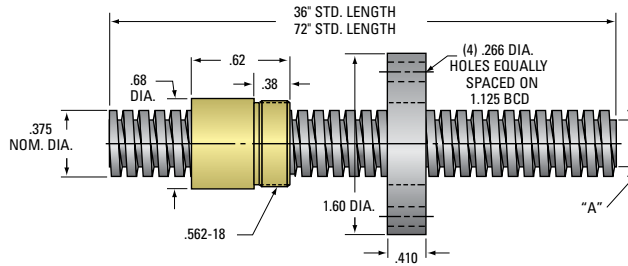

3/8" ACME THREAD
Lead Accuracy 0.0003 in/in

	BRONZE NUT						PLASTIC NUT					FLANGE		
	Part Number RH LH	% Efficiency	Torque* (in lb)	Load Capacity (lb) Dynamic Static	Wt. (lb)	Part Number RH LH	% Efficiency	Torque* (in lb)	Load Capacity (lb) Dynamic Static	Wt. (lb)	Std.	No-Lash™	Wt. (lb)	
	— —	—	—	— —	—	30031 —	80	.199	351 351	.01	70160	73160	.23	
	— —	—	—	— —	—	30031 —	80	.199	351 351	.01	70160	73160	.23	
	20037 —	74	.107	703 2,250	.05	30037 —	79	.101	351 351	.01	70160	73160	.23	
	20037 —	74	.107	703 2,250	.05	30037 —	79	.101	351 351	.01	70160	73160	.23	
	20037 —	74	.107	703 2,250	.05	30037 —	79	.101	351 351	.01	70160	73160	.23	
	20037 —	74	.107	703 2,250	.05	30037 —	79	.101	351 351	.01	70160	73160	.23	
	20034 —	69	.063	703 2,250	.05	30034 —	69	.057	351 351	.01	70160	73160	.23	
	20034 —	69	.063	703 2,250	.05	30034 —	69	.057	351 351	.01	70160	73160	.23	
	20034 —	69	.063	703 2,250	.05	30034 —	69	.057	351 351	.01	70160	73160	.23	
	20034 —	69	.063	703 2,250	.05	30034 —	69	.057	351 351	.01	70160	73160	.23	
	20035 —	59	.054	703 2,250	.05	— —	—	—	— —	.01	70160	73160	.23	
	20035 —	59	.054	703 2,250	.05	— —	—	—	— —	.01	70160	73160	.23	
	20035 —	59	.054	703 2,250	.05	— —	—	—	— —	.01	70160	73160	.23	
	20035 —	59	.054	703 2,250	.05	— —	—	—	— —	.01	70160	73160	.23	
	20036 80036	54	.049	703 2,250	.05	30036 40036	60	.044	351 351	.01	70160	73160	.23	
	20036 —	54	.049	703 2,250	.05	30036 40036	60	.044	351 351	.01	70160	73160	.23	
	20036 80036	54	.049	703 2,250	.05	30036 40036	60	.044	351 351	.01	70160	73160	.23	
	20036 —	54	.049	703 2,250	.05	30036 40036	60	.044	351 351	.01	70160	73160	.23	

* Torque required to raise 1 lb.

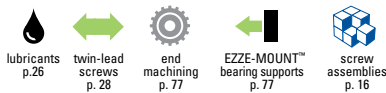

3/8 inch diameter (cont.)

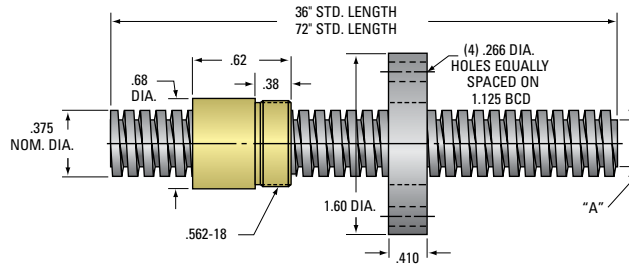

3/8" ACME THREAD
Lead Accuracy 0.0003 in/in

ACME SCREW													
Screw Size	Part Number		Length (in)	Material	Lead (in)	Pitch (in)	Starts	Threads per in	Lash (max axial)	"A" Dia (in)	Wt. (lb/ft)	Thread Code	Form
	RH	LH											
3/8" - 8	11038	—	36	4140	.125	.125	1	8	.009	.278	.29	038	Stub
	91038	—	36	SS	.125	.125	1	8	.009	.278	.29	038	Stub
	12038	—	72	4140	.125	.125	1	8	.009	.278	.29	038	Stub
	92038	—	72	SS	.125	.125	1	8	.009	.278	.29	038	Stub
3/8" - 10	11030	—	36	4140	.100	.100	1	10	.008	.282	.29	030	Stub
	91030	—	36	SS	.100	.100	1	10	.008	.282	.29	030	Stub
	12030	—	72	4140	.100	.100	1	10	.008	.282	.29	030	Stub
	92030	—	72	SS	.100	.100	1	10	.008	.282	.29	030	Stub
3/8" - 12	11032	51032	36	4140	.083	.083	1	12	.006	.263	.29	032	2C
	91032	94032	36	SS	.083	.083	1	12	.006	.263	.29	032	2C
	12032	52032	72	4140	.083	.083	1	12	.006	.263	.29	032	2C
	92032	95032	72	SS	.083	.083	1	12	.006	.263	.29	032	2C
3/8" - 16	11033	—	36	4140	.062	.062	1	16	.007	.286	.29	033	Stub
	91033	—	36	SS	.062	.062	1	16	.007	.286	.29	033	Stub
	12033	—	72	4140	.062	.062	1	16	.007	.286	.29	033	Stub
	92033	—	72	SS	.062	.062	1	16	.007	.286	.29	033	Stub

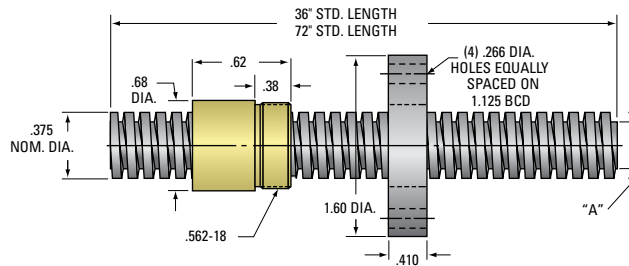

3/8" ACME THREAD
Lead Accuracy 0.0003 in/in

	BRONZE NUT						PLASTIC NUT					FLANGE		
	Part Number RH LH	% Efficiency	Torque* (in lb)	Load Capacity (lb) Dynamic Static	Wt. (lb)		Part Number RH LH	% Efficiency	Torque* (in lb)	Load Capacity (lb) Dynamic Static	Wt. (lb)	Std.	No-Lash™	Wt. (lb)
	20038 —	48	.042	703 2,250	.05		30038 —	54	.037	351 351	.01	70160	73160	.23
	20038 —	48	.042	703 2,250	.05		30038 —	54	.037	351 351	.01	70160	73160	.23
	20038 —	48	.042	703 2,250	.05		30038 —	54	.037	351 351	.01	70160	73160	.23
	20038 —	48	.042	703 2,250	.05		30038 —	54	.037	351 351	.01	70160	73160	.23
	20030 —	48	.033	703 2,250	.05		30030 —	48	.033	351 351	.01	70160	73160	.23
	20030 —	48	.033	703 2,250	.05		30030 —	48	.033	351 351	.01	70160	73160	.23
	20030 —	48	.033	703 2,250	.05		30030 —	48	.033	351 351	.01	70160	73160	.23
	20030 —	48	.033	703 2,250	.05		30030 —	48	.033	351 351	.01	70160	73160	.23
	20032 80032	37	.033	703 2,250	.05		30032 —	43	.031	351 351	.01	70160	73160	.23
	20032 80032	37	.033	703 2,250	.05		30032 —	43	.031	351 351	.01	70160	73160	.23
	20032 80032	37	.033	703 2,250	.05		30032 —	43	.031	351 351	.01	70160	73160	.23
	20032 80032	37	.033	703 2,250	.05		30032 —	43	.031	351 351	.01	70160	73160	.23
	20033 —	35	.033	703 2,250	.05		— —	— —	— —	.01	70160	73160	.23	
	20033 —	35	.028	703 2,250	.05		— —	— —	— —	.01	70160	73160	.23	
	20033 —	35	.028	703 2,250	.05		— —	— —	— —	.01	70160	73160	.23	
	20033 —	35	.028	703 2,250	.05		— —	— —	— —	.01	70160	73160	.23	

* Torque required to raise 1 lb.

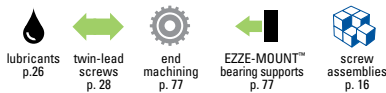

1/2 inch diameter

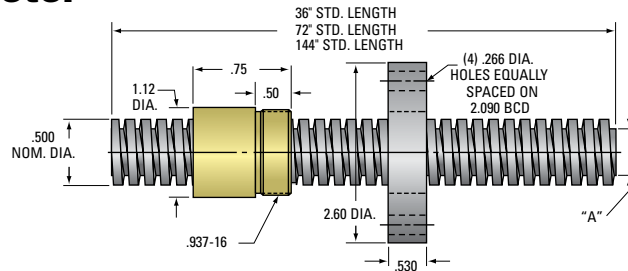

1/2" ACME THREAD
Lead Accuracy 0.0003 in/in

ACME SCREW												
Screw Size	Part Number RH LH	Length (in)	Material	Lead (in)	Pitch (in)	Starts	Threads per in	Lash (max axial)	"A" Dia (in)	Wt. (lb/ft)	Thread Code	Form
1/2" - 1	11051 —	36	4140	1.00	.125	8	8	.007	.392	.53	051	Stub
	91051 —	36	SS	1.00	.125	8	8	.007	.392	.53	051	Stub
	12051 —	72	4140	1.00	.125	8	8	.007	.392	.53	051	Stub
	92051 —	72	SS	1.00	.125	8	8	.007	.392	.53	051	Stub
	13051 —	144	4140	1.00	.125	8	8	.007	.392	.53	051	Stub
	93051 —	144	SS	1.00	.125	8	8	.007	.392	.53	051	Stub
1/2" - 2	11052 —	36	4140	.500	.100	5	10	.006	.406	.53	052	Stub
	91052 —	36	SS	.500	.100	5	10	.006	.406	.53	052	Stub
	12052 —	72	4140	.500	.100	5	10	.006	.406	.53	052	Stub
	92052 —	72	SS	.500	.100	5	10	.006	.406	.53	052	Stub
	13052 —	144	4140	.500	.100	5	10	.006	.406	.53	052	Stub
	93052 —	144	SS	.500	.100	5	10	.006	.406	.53	052	Stub
1/2" - 4	11054 —	36	4140	.250	.125	2	8	.007	.332	.53	054	2C
	91054 —	36	SS	.250	.125	2	8	.007	.332	.53	054	2C
	12054 —	72	4140	.250	.125	2	8	.007	.332	.53	054	2C
	92054 —	72	SS	.250	.125	2	8	.007	.332	.53	054	2C
	13054 —	144	4140	.250	.125	2	8	.007	.332	.53	054	2C
	93054 —	144	SS	.250	.125	2	8	.007	.332	.53	054	2C
1/2" - 5	11055 —	36	4140	.200	.100	2	10	.009	.391	.53	055	Stub
	91055 —	36	SS	.200	.100	2	10	.009	.391	.53	055	Stub
	12055 —	72	4140	.200	.100	2	10	.009	.391	.53	055	Stub
	92055 —	72	SS	.200	.100	2	10	.009	.391	.53	055	Stub
	13055 —	144	4140	.200	.100	2	10	.009	.391	.53	055	Stub
	93055 —	144	SS	.200	.100	2	10	.009	.391	.53	055	Stub
1/2" - 10	11050 51050	36	4140	.100	.100	1	10	.007	.359	.53	050	2C
	91050 94050	36	SS	.100	.100	1	10	.007	.359	.53	050	2C
	12050 52050	72	4140	.100	.100	1	10	.007	.359	.53	050	2C
	92050 95050	72	SS	.100	.100	1	10	.007	.359	.53	050	2C
	13050 53050	144	4140	.100	.100	1	10	.007	.359	.53	050	2C
	93050 96050	144	SS	.100	.100	1	10	.007	.359	.53	050	2C

POWER • AC™ ACME SCREW ASSEMBLIES

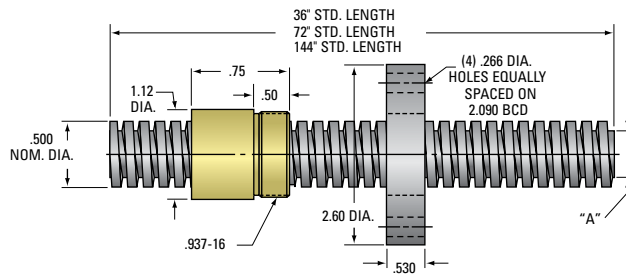

½" ACME THREAD
Lead Accuracy 0.0003 in/in

ACME SCREW ASSEMBLIES

		BRONZE NUT					PLASTIC NUT					FLANGE				
Part Number	RH LH	% Efficiency	Torque* (in lb)	Load Capacity (lb)		Wt. (lb)	Part Number	RH LH	% Efficiency	Torque* (in lb)	Load Capacity (lb)		Wt. (lb)	Std.	No-Lash™	Wt. (lb)
				Dynamic	Static						Dynamic	Static				
20051	—	77	.210	1,250	4,000	.13	30051	—	80	.196	625	625	.03	FLG7570	73260	.77
20051	—	77	.210	1,250	4,000	.13	30051	—	80	.196	625	625	.03	FLG7570	73260	.77
20051	—	77	.210	1,250	4,000	.13	30051	—	80	.196	625	625	.03	FLG7570	73260	.77
20051	—	77	.210	1,250	4,000	.13	30051	—	80	.196	625	625	.03	FLG7570	73260	.77
20051	—	77	.210	1,250	4,000	.13	30051	—	80	.196	625	625	.03	FLG7570	73260	.77
20051	—	77	.210	1,250	4,000	.13	30051	—	80	.196	625	625	.03	FLG7570	73260	.77
20052	—	69	.115	1,250	4,000	.18	30052	—	75	.107	625	625	.03	FLG7570	73260	.77
20052	—	69	.115	1,250	4,000	.18	30052	—	75	.107	625	625	.03	FLG7570	73260	.77
20052	—	69	.115	1,250	4,000	.18	30052	—	75	.107	625	625	.03	FLG7570	73260	.77
20052	—	69	.115	1,250	4,000	.18	30052	—	75	.107	625	625	.03	FLG7570	73260	.77
20052	—	69	.115	1,250	4,000	.18	30052	—	75	.107	625	625	.03	FLG7570	73260	.77
20052	—	69	.115	1,250	4,000	.18	30052	—	75	.107	625	625	.03	FLG7570	73260	.77
20054	—	57	.070	1,250	4,000	.19	30054	—	63	.064	625	625	.03	FLG7570	73260	.77
20054	—	57	.070	1,250	4,000	.19	30054	—	63	.064	625	625	.03	FLG7570	73260	.77
20054	—	57	.070	1,250	4,000	.19	30054	—	63	.064	625	625	.03	FLG7570	73260	.77
20054	—	57	.070	1,250	4,000	.19	30054	—	63	.064	625	625	.03	FLG7570	73260	.77
20054	—	57	.070	1,250	4,000	.19	30054	—	63	.064	625	625	.03	FLG7570	73260	.77
20054	—	57	.070	1,250	4,000	.19	30054	—	63	.064	625	625	.03	FLG7570	73260	.77
20055	—	52	.061	1,250	4,000	.18	30055	—	57	.056	625	625	.03	FLG7570	73260	.77
20055	—	52	.061	1,250	4,000	.18	30055	—	57	.056	625	625	.03	FLG7570	73260	.77
20055	—	52	.061	1,250	4,000	.18	30055	—	57	.056	625	625	.03	FLG7570	73260	.77
20055	—	52	.061	1,250	4,000	.18	30055	—	57	.056	625	625	.03	FLG7570	73260	.77
20055	—	52	.061	1,250	4,000	.18	30055	—	57	.056	625	625	.03	FLG7570	73260	.77
20055	—	52	.061	1,250	4,000	.18	30055	—	57	.056	625	625	.03	FLG7570	73260	.77
20050	80050	34	.047	1,250	4,000	.18	30050	—	40	.039	625	625	.03	FLG7570	73260	.77
20050	80050	34	.047	1,250	4,000	.18	30050	—	40	.039	625	625	.03	FLG7570	73260	.77
20050	80050	34	.047	1,250	4,000	.18	30050	—	40	.039	625	625	.03	FLG7570	73260	.77
20050	80050	34	.047	1,250	4,000	.18	30050	—	40	.039	625	625	.03	FLG7570	73260	.77
20050	80050	34	.047	1,250	4,000	.18	30050	—	40	.039	625	625	.03	FLG7570	73260	.77
20050	80050	34	.047	1,250	4,000	.18	30050	—	40	.039	625	625	.03	FLG7570	73260	.77

* Torque required to raise 1 lb.

5/8 inch diameter

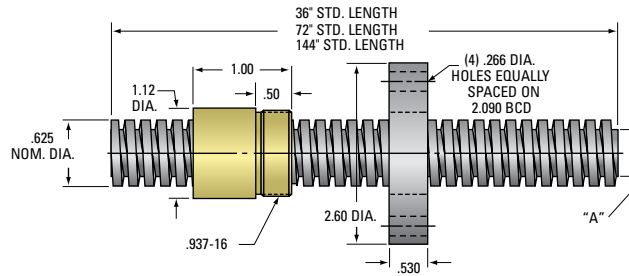

5/8" ACME THREAD
Lead Accuracy 0.0003 in/in

ACME SCREW													
Screw Size	Part Number		Length (in)	Material	Lead (in)	Pitch (in)	Starts	Threads per in	Lash (max axial)	"A" Dia (in)	Wt. (lb/ft)	Thread Code	Form
	RH	LH											
5/8" - 2 2/3	11063	51063	36	4140	.375	.125	3	8	.010	.457	.84	063	2C
	12063	52063	72	4140	.375	.125	3	8	.010	.457	.84	063	2C
	13063	53063	144	4140	.375	.125	3	8	.010	.457	.84	063	2C
5/8" - 5	11065	51065	36	4140	.200	.200	1	5	.009	.377	.84	065	2C
	12065	52065	72	4140	.200	.200	1	5	.009	.377	.84	065	2C
	13065	53065	144	4140	.200	.200	1	5	.009	.377	.84	065	2C
5/8" - 5 ⁽²⁾	11652	—	36	4140	.200	.100	2	10	.009	.484	.85	652	2C
	91652	—	36	SS	.200	.100	2	10	.009	.484	.85	652	2C
	12652	—	72	4140	.200	.100	2	10	.009	.484	.85	652	2C
	92652	—	72	SS	.200	.100	2	10	.009	.484	.85	652	2C
	13652	—	144	4140	.200	.100	2	10	.009	.484	.85	652	2C
	13652	—	144	SS	.200	.100	2	10	.009	.484	.85	652	2C
5/8" - 8	11068	51068	36	4140	.125	.125	1	8	.008	.457	.84	068	2C
	91068	94068	36	SS	.125	.125	1	8	.008	.457	.84	068	2C
	12068	52068	72	4140	.125	.125	1	8	.008	.457	.84	068	2C
	92068	95068	72	SS	.125	.125	1	8	.008	.457	.84	068	2C
	13068	53068	144	4140	.125	.125	1	8	.008	.457	.84	068	2C
	93068	96068	144	SS	.125	.125	1	8	.008	.457	.84	068	2C
5/8" - 10	11060	—	36	4140	.100	.100	1	10	.009	.516	.87	060	Stub
	91060	—	36	SS	.100	.100	1	10	.009	.516	.87	060	Stub
	12060	—	72	4140	.100	.100	1	10	.009	.516	.87	060	Stub
	92060	—	72	SS	.100	.100	1	10	.009	.516	.87	060	Stub
	13060	—	144	4140	.100	.100	1	10	.009	.516	.87	060	Stub
	93060	—	144	SS	.100	.100	1	10	.009	.516	.87	060	Stub

POWER • AC™ ACME SCREW ASSEMBLIES

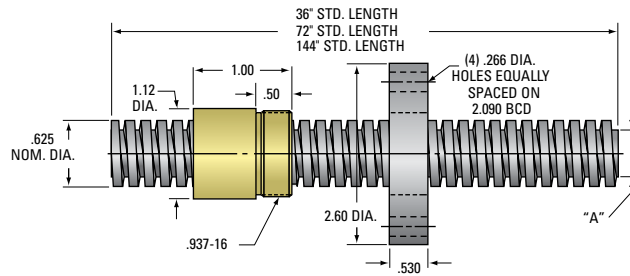

5/8" ACME THREAD
Lead Accuracy 0.0003 in/in

		BRONZE NUT					PLASTIC NUT					FLANGE				
		Part Number RH LH	% Efficiency	Torque* (in lb)	Load Capacity (lb) Dynamic Static		Wt. (lb)	Part Number RH LH	% Efficiency	Torque* (in lb)	Load Capacity (lb) Dynamic Static		Wt. (lb)	Std.	No-Lash™	Wt. (lb)
		20063 80063	60	.100	1,953	6,250	.22	30063 —	66	.091	976	976	.03	FLG7570	73260	.77
		20063 80063	60	.100	1,953	6,250	.22	30063 —	66	.091	976	976	.03	FLG7570	73260	.77
		20063 80063	60	.100	1,953	6,250	.22	30063 —	66	.091	976	976	.03	FLG7570	73260	.77
		20065 80065	44	.072	1,953	6,250	.23	30065 —	53	.072	976	976	.03	FLG7570	73260	.77
		20065 80065	44	.072	1,953	6,250	.23	30065 —	53	.072	976	976	.03	FLG7570	73260	.77
		20065 80065	44	.072	1,953	6,250	.23	30065 —	53	.072	976	976	.03	FLG7570	73260	.77
		20652 —	46	.069	1,953	6,250	.22	30652 —	51	.069	976	976	.03	FLG7570	73260	.77
		20652 —	46	.069	1,953	6,250	.22	30652 —	51	.069	976	976	.03	FLG7570	73260	.77
		20652 —	46	.069	1,953	6,250	.22	30652 —	51	.069	976	976	.03	FLG7570	73260	.77
		20652 —	46	.069	1,953	6,250	.22	30652 —	51	.069	976	976	.03	FLG7570	73260	.77
		20652 —	46	.069	1,953	6,250	.22	30652 —	51	.069	976	976	.03	FLG7570	73260	.77
		20068 80068	34	.058	1,953	6,250	.22	30068 —	40	.058	976	976	.03	FLG7570	73260	.77
		20068 80068	34	.058	1,953	6,250	.22	30068 —	40	.058	976	976	.03	FLG7570	73260	.77
		20068 80068	34	.058	1,953	6,250	.22	30068 —	40	.058	976	976	.03	FLG7570	73260	.77
		20068 80068	34	.058	1,953	6,250	.22	30068 —	40	.058	976	976	.03	FLG7570	73260	.77
		20068 80068	34	.058	1,953	6,250	.22	30068 —	40	.058	976	976	.03	FLG7570	73260	.77
		20068 80068	34	.058	1,953	6,250	.22	30068 —	40	.058	976	976	.03	FLG7570	73260	.77
		20060 —	30	.053	1,953	6,250	.21	30060 —	35	.053	976	976	.03	FLG7570	73260	.77
		20060 —	30	.053	1,953	6,250	.21	30060 —	35	.053	976	976	.03	FLG7570	73260	.77
		20060 —	30	.053	1,953	6,250	.21	30060 —	35	.053	976	976	.03	FLG7570	73260	.77
		20060 —	30	.053	1,953	6,250	.21	30060 —	35	.053	976	976	.03	FLG7570	73260	.77
		20060 —	30	.053	1,953	6,250	.21	30060 —	35	.053	976	976	.03	FLG7570	73260	.77
		20060 —	30	.053	1,953	6,250	.21	30060 —	35	.053	976	976	.03	FLG7570	73260	.77

* Torque required to raise 1 lb.

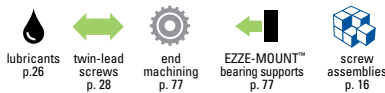

3/4 inch diameter
7/8 inch diameter

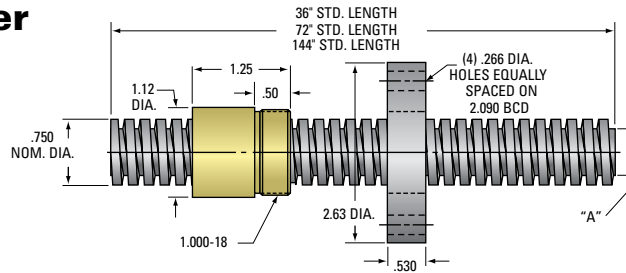

3/4" ACME THREAD
Lead Accuracy 0.0003 in/in

Screw Size	ACME SCREW												
	Part Number RH LH	Length (in)	Material	Lead (in)	Pitch (in)	Starts	Threads per in	Lash (max axial)	"A" Dia (in)	Wt. (lb/ft)	Thread Code	Form	
3/4" - 2	11072**	—	36	1018	.500	.125	4	8	.010	.581	1.18	072	2C
	12072**	—	72	1018	.500	.125	4	8	.010	.581	1.18	072	2C
	13072**	—	144	1018	.500	.125	4	8	.010	.581	1.18	072	2C
3/4" - 3	10173	51073	36	4140	.333	.167	2	6	.009	.537	1.17	073	2C
	12073	52073	72	4140	.333	.167	2	6	.009	.537	1.17	073	2C
	13073	53073	144	4140	.333	.167	2	6	.009	.537	1.17	073	2C
3/4" - 5	11075	51075	36	4140	.200	.200	1	5	.009	.502	1.23	075	2C
	91075	94075	36	SS	.200	.200	1	5	.009	.502	1.23	075	2C
	12075	52075	72	4140	.200	.200	1	5	.009	.502	1.23	075	2C
	92075	95075	72	SS	.200	.200	1	5	.009	.502	1.23	075	2C
	13075	53075	144	4140	.200	.200	1	5	.009	.502	1.23	075	2C
3/4" - 6	93075	96075	144	SS	.200	.200	1	5	.009	.502	1.23	075	2C
	11076	51076	36	4140	.166	.166	1	6	.008	.537	1.17	076	2C
	91076	94076	36	SS	.166	.166	1	6	.008	.537	1.17	076	2C
	12076	52076	72	4140	.166	.166	1	6	.008	.537	1.17	076	2C
	92076	95076	72	SS	.166	.166	1	6	.008	.537	1.17	076	2C
3/4" - 10	13076	53076	144	4140	.166	.166	1	6	.008	.537	1.17	076	2C
	93076	96076	144	SS	.166	.166	1	6	.008	.537	1.17	076	2C
	11070	51070	36	4140	.100	.100	1	10	.007	.608	1.29	070	2C
	91070	94070	36	SS	.100	.100	1	10	.007	.608	1.29	070	2C
	12070	52070	72	4140	.100	.100	1	10	.007	.608	1.29	070	2C
7/8" - 6	92070	95070	72	SS	.100	.100	1	10	.007	.608	1.29	070	2C
	13070	53070	144	4140	.100	.100	1	10	.007	.608	1.29	070	2C
	93070	96070	144	SS	.100	.100	1	10	.007	.608	1.29	070	2C
7/8" - 6	11086	51086	36	4140	.166	.166	1	6	.009	.661	1.65	086	2C
	12086	52086	72	4140	.166	.166	1	6	.009	.661	1.65	086	2C
	13086	53086	144	4140	.166	.166	1	6	.009	.661	1.65	086	2C

** These screws are made with low carbon steel

POWER • AC™ ACME SCREW ASSEMBLIES

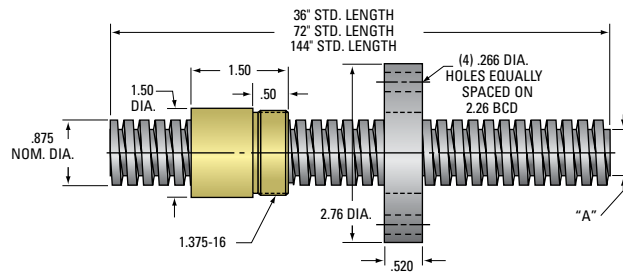

3/8" ACME THREAD
Lead Accuracy 0.0003 in/in

ACME SCREW ASSEMBLIES

		BRONZE NUT					PLASTIC NUT					FLANGE				
Part Number RH	LH	% Efficiency	Torque* (in lb)	Load Capacity (lb)		Wt. (lb)	Part Number RH	LH	% Efficiency	Torque* (in lb)	Load Capacity (lb)		Wt. (lb)	Std.	No-Lash™	Wt. (lb)
				Dynamic	Static						Dynamic	Static				
20072	—	62	.129	2,812	9,000	.23	30072	—	68	.118	1,406	1,406	.03	70262	73262	.78
20072	—	62	.129	2,812	9,000	.23	30072	—	68	.118	1,406	1,406	.03	70262	73262	.78
20072	—	62	.129	2,812	9,000	.23	30072	—	68	.118	1,406	1,406	.03	70262	73262	.78
20073	80073	54	.099	2,812	9,000	.23	30073	—	60	.089	1,406	1,406	.03	70262	73262	.78
20073	80073	54	.099	2,812	9,000	.23	30073	—	60	.089	1,406	1,406	.03	70262	73262	.78
20073	80073	54	.099	2,812	9,000	.23	30073	—	60	.089	1,406	1,406	.03	70262	73262	.78
20075	80075	40	.080	2,812	9,000	.24	30075	—	48	.066	1,406	1,406	.03	70262	73262	.78
20075	80075	40	.080	2,812	9,000	.24	30075	—	48	.066	1,406	1,406	.03	70262	73262	.78
20075	80075	40	.080	2,812	9,000	.24	30075	—	48	.066	1,406	1,406	.03	70262	73262	.78
20075	80075	40	.080	2,812	9,000	.24	30075	—	48	.066	1,406	1,406	.03	70262	73262	.78
20075	80075	40	.080	2,812	9,000	.24	30075	—	48	.066	1,406	1,406	.03	70262	73262	.78
20075	80075	40	.080	2,812	9,000	.24	30075	—	48	.066	1,406	1,406	.03	70262	73262	.78
20076	80076	36	.073	2,812	9,000	.23	30076	40076	43	.061	1,406	1,406	.03	70262	73262	.78
20076	80076	36	.073	2,812	9,000	.23	30076	40076	43	.061	1,406	1,406	.03	70262	73262	.78
20076	80076	36	.073	2,812	9,000	.23	30076	40076	43	.061	1,406	1,406	.03	70262	73262	.78
20076	80076	36	.073	2,812	9,000	.23	30076	40076	43	.061	1,406	1,406	.03	70262	73262	.78
20076	80076	36	.073	2,812	9,000	.23	30076	40076	43	.061	1,406	1,406	.03	70262	73262	.78
20076	80076	36	.073	2,812	9,000	.23	30076	40076	43	.061	1,406	1,406	.03	70262	73262	.78
20070	80070	25	.064	2,812	9,000	.22	30070	—	30	.052	1,406	1,406	.03	70262	73262	.78
20070	80070	25	.064	2,812	9,000	.22	30070	—	30	.052	1,406	1,406	.03	70262	73262	.78
20070	80070	25	.064	2,812	9,000	.22	30070	—	30	.052	1,406	1,406	.03	70262	73262	.78
20070	80070	25	.064	2,812	9,000	.22	30070	—	30	.052	1,406	1,406	.03	70262	73262	.78
20070	80070	25	.064	2,812	9,000	.22	30070	—	30	.052	1,406	1,406	.03	70262	73262	.78
20070	80070	25	.064	2,812	9,000	.22	30070	—	30	.052	1,406	1,406	.03	70262	73262	.78
20086	80086	32	.083	3,828	12,250	.57	—	—	39	.068	1,914	1,914	.08	FLG8281	73275	.85
20086	80086	32	.083	3,828	12,250	.57	—	—	39	.068	1,914	1,914	.08	FLG8281	73275	.85
20086	80086	32	.083	3,828	12,250	.57	—	—	39	.068	1,914	1,914	.08	FLG8281	73275	.85

* Torque required to raise 1 lb



1 inch diameter

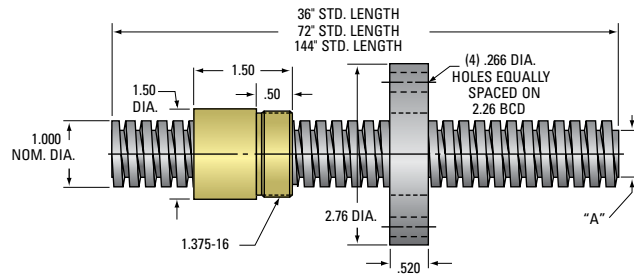

1" ACME THREAD
Lead Accuracy 0.0003 in/in

Screw Size	ACME SCREW											
	Part Number RH LH	Length (in)	Material	Lead (in)	Pitch (in)	Starts	Threads per in	Lash (max axial)	"A" Dia (in)	Wt. (lb/ft)	Thread Code	Form
1"-1	11111 51111	36	4140	1.00	.100	10	10	.008	.906	2.38	111	Stub
	12111 52111	72	4140	1.00	.100	10	10	.008	.906	2.38	111	Stub
	13111 53111	144	4140	1.00	.100	10	10	.008	.906	2.38	111	Stub
1"-2	11112 —	36	4140	.500	.250	2	4	.010	.698	2.22	112	2C
	12112 —	72	4140	.500	.250	2	4	.010	.698	2.22	112	2C
	13112 —	144	4140	.500	.250	2	4	.010	.698	2.22	112	2C
1"-4	11104 51104	36	4140	.250	.250	1	4	.010	.698	2.22	104	2C
	91104 94104	36	SS	.250	.250	1	4	.010	.698	2.22	104	2C
	12104 52104	72	4140	.250	.250	1	4	.010	.698	2.22	104	2C
	92104 95104	72	SS	.250	.250	1	4	.010	.698	2.22	104	2C
	13104 53104	144	4140	.250	.250	1	4	.010	.698	2.22	104	2C
	93104 54104	144	SS	.250	.250	1	4	.010	.698	2.22	104	2C

1" ACME THREAD SCREW ASSEMBLIES
CONTINUED ON NEXT PAGE

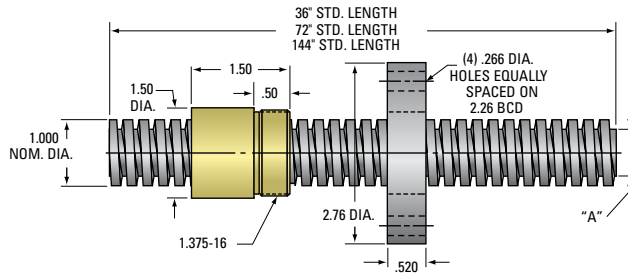

1" ACME THREAD
Lead Accuracy 0.0003 in/in

	BRONZE NUT						PLASTIC NUT						FLANGE				
	Part Number RH	Part Number LH	% Efficiency	Torque* (in lb)	Load Capacity (lb) Dynamic	Load Capacity (lb) Static	Wt. (lb)	Part Number RH	Part Number LH	% Efficiency	Torque* (in lb)	Load Capacity (lb) Dynamic	Load Capacity (lb) Static	Wt. (lb)	Std.	No- Lash™	Wt. (lb)
	20111	80111	69	.231	5,000	16,000	.46	30111	—	74	.216	2,500	2,500	.07	FLG8281	73275	.85
	20111	80111	69	.231	5,000	16,000	.46	30111	—	74	.216	2,500	2,500	.07	FLG8281	73275	.85
	20111	80111	69	.231	5,000	16,000	.46	30111	—	74	.216	2,500	2,500	.07	FLG8281	73275	.85
	20112	—	57	.139	5,000	16,000	.52	30112	—	63	.127	2,500	2,500	.08	FLG8281	73275	.85
	20112	—	57	.139	5,000	16,000	.52	30112	—	63	.127	2,500	2,500	.08	FLG8281	73275	.85
	20112	—	57	.139	5,000	16,000	.52	30112	—	63	.127	2,500	2,500	.08	FLG8281	73275	.85
	20104	80104	38	.105	5,000	16,000	.52	30104	—	46	.086	2,500	2,500	.08	FLG8281	73275	.85
	20104	80104	38	.105	5,000	16,000	.52	30104	—	46	.086	2,500	2,500	.08	FLG8281	73275	.85
	20104	80104	38	.105	5,000	16,000	.52	30104	—	46	.086	2,500	2,500	.08	FLG8281	73275	.85
	20104	80104	38	.105	5,000	16,000	.52	30104	—	46	.086	2,500	2,500	.08	FLG8281	73275	.85
	20104	80104	38	.105	5,000	16,000	.52	30104	—	46	.086	2,500	2,500	.08	FLG8281	73275	.85
	20104	80104	38	.105	5,000	16,000	.52	30104	—	46	.086	2,500	2,500	.08	FLG8281	73275	.85

* Torque required to raise 1 lb.

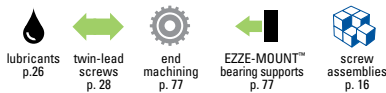

1 inch diameter (cont.)

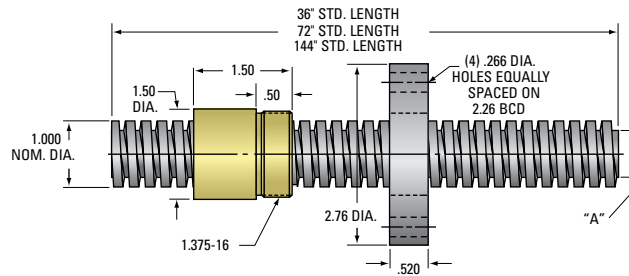

1" ACME THREAD
Lead Accuracy 0.0003 in/in

ACME SCREW													
Screw Size	Part Number		Length (in)	Material	Lead (in)	Pitch (in)	Starts	Threads per in	Lash (max axial)	"A" Dia (in)	Wt. (lb/ft)	Thread Code	Form
	RH	LH											
1" - 5	11105	51105	36	4140	.200	.200	1	5	.009	.750	2.16	105	2C
	91105	—	36	SS	.200	.200	1	5	.009	.750	2.16	105	2C
	12105	52105	72	4140	.200	.200	1	5	.009	.750	2.16	105	2C
	92105	—	72	SS	.200	.200	1	5	.009	.750	2.16	105	2C
	13105	53105	144	4140	.200	.200	1	5	.009	.750	2.16	105	2C
	93105	—	144	SS	.200	.200	1	5	.009	.750	2.16	105	2C
1" - 6	11106	51106	36	4140	.167	.167	1	6	.009	.786	2.16	106	2C
	91106	94106	36	SS	.167	.167	1	6	.009	.786	2.16	106	2C
	12106	52106	72	4140	.167	.167	1	6	.009	.786	2.16	106	2C
	92106	95106	72	SS	.167	.167	1	6	.009	.786	2.16	106	2C
	13106	13106	144	4140	.167	.167	1	6	.009	.786	2.16	106	2C
	93106	96106	144	SS	.167	.167	1	6	.009	.786	2.16	106	2C
1" - 10	11110	51110	36	4140	.100	.100	1	10	.008	.857	2.10	110	2C
	91110	—	36	SS	.100	.100	1	10	.008	.857	2.10	110	2C
	12110	52110	72	4140	.100	.100	1	10	.008	.857	2.10	110	2C
	92110	—	72	SS	.100	.100	1	10	.008	.857	2.10	110	2C
	13110	53110	144	4140	.100	.100	1	10	.008	.857	2.10	110	2C
	93110	—	144	SS	.100	.100	1	10	.008	.857	2.10	110	2C

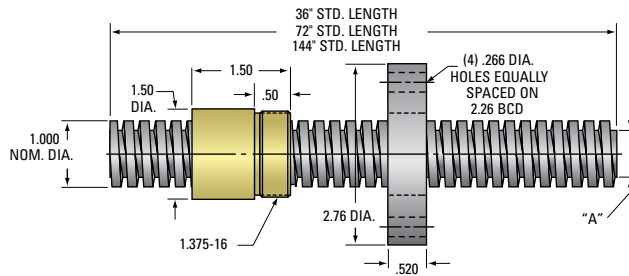

1" ACME THREAD
Lead Accuracy 0.0003 in/in

	BRONZE NUT							PLASTIC NUT					FLANGE				
	Part Number RH	Part Number LH	% Efficiency	Torque* (in lb)	Load Capacity (lb) Dynamic	Load Capacity (lb) Static	Wt. (lb)	Part Number RH	Part Number LH	% Efficiency	Torque* (in lb)	Load Capacity (lb) Dynamic	Load Capacity (lb) Static	Wt. (lb)	Std.	No- Lash™	Wt. (lb)
	20105	80105	34	.094	5,000	16,000	.50	30105	40105	40	.079	2,500	2,500	.07	FLG8281	73275	.85
	20105	80105	34	.094	5,000	16,000	.50	30105	40105	40	.079	2,500	2,500	.07	FLG8281	73275	.85
	20105	80105	34	.094	5,000	16,000	.50	30105	40105	40	.079	2,500	2,500	.07	FLG8281	73275	.85
	20105	80105	34	.094	5,000	16,000	.50	30105	40105	40	.079	2,500	2,500	.07	FLG8281	73275	.85
	20105	80105	34	.094	5,000	16,000	.50	30105	40105	40	.079	2,500	2,500	.07	FLG8281	73275	.85
	20105	80105	34	.094	5,000	16,000	.50	30105	40105	40	.079	2,500	2,500	.07	FLG8281	73275	.85
	20106	80106	30	.089	5,000	16,000	.49	30106	40106	42	.063	2,500	2,500	.07	FLG8281	73275	.85
	20106	80106	30	.089	5,000	16,000	.49	30106	40106	42	.063	2,500	2,500	.07	FLG8281	73275	.85
	20106	80106	30	.089	5,000	16,000	.49	30106	40106	42	.063	2,500	2,500	.07	FLG8281	73275	.85
	20106	80106	30	.089	5,000	16,000	.49	30106	40106	42	.063	2,500	2,500	.07	FLG8281	73275	.85
	20106	80106	30	.089	5,000	16,000	.49	30106	40106	42	.063	2,500	2,500	.07	FLG8281	73275	.85
	20106	80106	30	.089	5,000	16,000	.49	30106	40106	42	.063	2,500	2,500	.07	FLG8281	73275	.85
	20110	80110	20	.078	5,000	16,000	.47	30110	40110	24	.065	2,500	2,500	.07	FLG8281	73275	.85
	20110	80110	20	.078	5,000	16,000	.47	30110	40110	24	.065	2,500	2,500	.07	FLG8281	73275	.85
	20110	80110	20	.078	5,000	16,000	.47	30110	40110	24	.065	2,500	2,500	.07	FLG8281	73275	.85
	20110	80110	20	.078	5,000	16,000	.47	30110	40110	24	.065	2,500	2,500	.07	FLG8281	73275	.85
	20110	80110	20	.078	5,000	16,000	.47	30110	40110	24	.065	2,500	2,500	.07	FLG8281	73275	.85
	20110	80110	20	.078	5,000	16,000	.47	30110	40110	24	.065	2,500	2,500	.07	FLG8281	73275	.85

* Torque required to raise 1 lb.

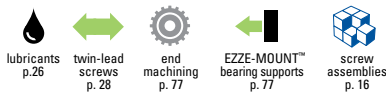

1 1/8 inch diameter
1 1/4 inch diameter

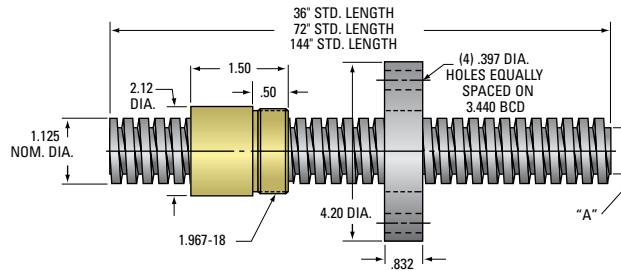

1 1/8" ACME THREAD
 Lead Accuracy 0.0003 in/in

ACME SCREW													
Screw Size	Part Number		Length (in)	Material	Lead (in)	Pitch (in)	Starts	Threads per in	Lash (max axial)	"A" Dia (in)	Wt. (lb/ft)	Thread Code	Form
	RH	LH											
1 1/8" - 5	11115	—	36	4140	.200	.200	1	5	.010	.875	2.80	115	2C
	12115	—	72	4140	.200	.200	1	5	.010	.875	2.80	115	2C
	13115	—	144	4140	.200	.200	1	5	.010	.875	2.80	115	2C
1 1/4" - 4	11124	51124	36	4140	.250	.250	1	4	.011	.947	3.34	124	2C
	91124	—	36	SS	.250	.250	1	4	.011	.947	3.34	124	2C
	12124	52124	72	4140	.250	.250	1	4	.011	.947	3.34	124	2C
	92124	—	72	SS	.250	.250	1	4	.011	.947	3.34	124	2C
	13124	53124	144	4140	.250	.250	1	4	.011	.947	3.34	124	2C
	93124	—	144	SS	.250	.250	1	4	.011	.947	3.34	124	2C
1 1/4" - 5	11125	51125	36	4140	.200	.200	1	5	.010	.999	3.49	125	2C
	91125	94125	36	SS	.200	.200	1	5	.010	.999	3.49	125	2C
	12125	52125	72	4140	.200	.200	1	5	.010	.999	3.49	125	2C
	92125	95125	72	SS	.200	.200	1	5	.010	.999	3.49	125	2C
	13125	53125	144	4140	.200	.200	1	5	.010	.999	3.49	125	2C
	93125	96125	144	SS	.200	.200	1	5	.010	.999	3.49	125	2C

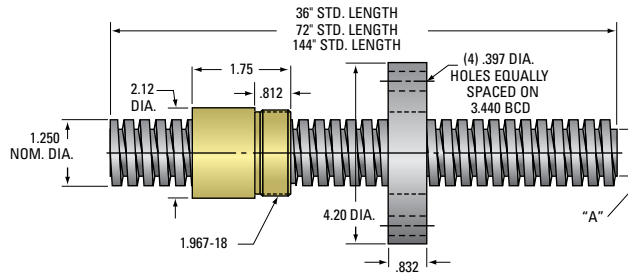

1 1/4" ACME THREAD
Lead Accuracy 0.0003 in/in

		BRONZE NUT					PLASTIC NUT					FLANGE					
	Part Number		% Efficiency	Torque* (in lb)	Load Capacity (lb)		Wt. (lb)	Part Number		% Efficiency	Torque* (in lb)	Load Capacity (lb)		Wt. (lb)	Std.		Wt. (lb)
	RH	LH			Dynamic	Static		RH	LH			Dynamic	Static		Std.	No-Lash™	
	20115	—	32	.100	6,330	20,500	1.21	30115	—	43	.073	3,100	3,100	—	FLG7572	73420	3.19
	20115	—	32	.100	6,330	20,500	1.21	30115	—	43	.073	3,100	3,100	—	FLG7572	73420	3.19
	20115	—	32	.100	6,330	20,500	1.21	30115	—	43	.073	3,100	3,100	—	FLG7572	73420	3.19
	20124	80124	34	.117	7,812	25,000	1.32	30124	—	47	.084	3,900	3,900	—	FLG7572	73420	3.19
	20124	80124	34	.117	7,812	25,000	1.32	30124	—	47	.084	3,900	3,900	—	FLG7572	73420	3.19
	20124	80124	34	.117	7,812	25,000	1.32	30124	—	47	.084	3,900	3,900	—	FLG7572	73420	3.19
	20124	80124	34	.117	7,812	25,000	1.32	30124	—	47	.084	3,900	3,900	—	FLG7572	73420	3.19
	20124	80124	34	.117	7,812	25,000	1.32	30124	—	47	.084	3,900	3,900	—	FLG7572	73420	3.19
	20125	80125	28	.114	7,812	25,000	1.29	30125	40125	35	.092	3,906	3,906	.19	FLG7572	73420	3.19
	20125	80125	28	.114	7,812	25,000	1.29	30125	40125	35	.092	3,906	3,906	.19	FLG7572	73420	3.19
	20125	80125	28	.114	7,812	25,000	1.29	30125	40125	35	.092	3,906	3,906	.19	FLG7572	73420	3.19
	20125	80125	28	.114	7,812	25,000	1.29	30125	40125	35	.092	3,906	3,906	.19	FLG7572	73420	3.19
	20125	80125	28	.114	7,812	25,000	1.29	30125	40125	35	.092	3,906	3,906	.19	FLG7572	73420	3.19
	20125	80125	28	.114	7,812	25,000	1.29	30125	40125	35	.092	3,906	3,906	.19	FLG7572	73420	3.19

* Torque required to raise 1 lb.

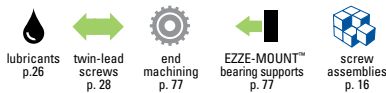

1 1/2 inch diameter

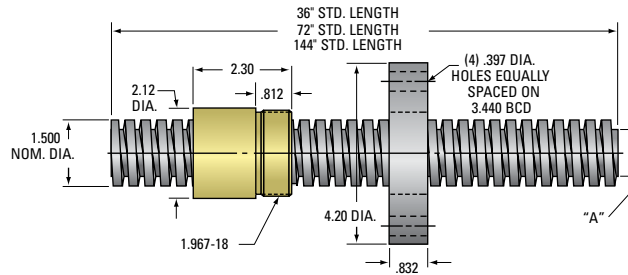

1 1/2" ACME THREAD
Lead Accuracy 0.0003 in/in

Screw Size	ACME SCREW												
	Part Number RH	Part Number LH	Length (in)	Material	Lead (in)	Pitch (in)	Starts	Threads per in	Lash (max axial)	"A" Dia (in)	Wt. (lb/ft)	Thread Code	Form
1 1/2" - 2	11152	—	36	4140	.500	.250	2	4	.012	1.196	4.95	152	2C
	12152	—	72	4140	.500	.250	2	4	.012	1.196	4.95	152	2C
	13152	—	144	4140	.500	.250	2	4	.012	1.196	4.95	152	2C
1 1/2" - 2 2/3	11153	51153	36	4140	.375	.375	1	2 2/3	.010	1.066	4.55	153	40°
	91153	—	36	SS	.375	.375	1	2 2/3	.010	1.066	4.55	153	40°
	12153	52153	72	4140	.375	.375	1	2 2/3	.010	1.066	4.55	153	40°
	92153	—	72	SS	.375	.375	1	2 2/3	.010	1.066	4.55	153	40°
	13153	53153	144	4140	.375	.375	1	2 2/3	.010	1.066	4.55	153	40°
93153	—	144	SS	.375	.375	1	2 2/3	.010	1.066	4.55	153	40°	
1 1/2" - 4	11154	51154	36	4140	.250	.250	1	4	.010	1.196	4.99	154	2C
	91154	94154	36	SS	.250	.250	1	4	.010	1.196	4.99	154	2C
	12154	52154	72	4140	.250	.250	1	4	.010	1.196	4.99	154	2C
	92154	95154	72	SS	.250	.250	1	4	.010	1.196	4.99	154	2C
	13154	53154	144	4140	.250	.250	1	4	.010	1.196	4.99	154	2C
	93154	96154	144	SS	.250	.250	1	4	.010	1.196	4.99	154	2C
1 1/2" - 5	11155	51155	36	4140	.200	.200	1	5	.010	1.249	4.90	155	2C
	91155	94155	36	SS	.200	.200	1	5	.010	1.249	4.90	155	2C
	12155	52155	72	4140	.200	.200	1	5	.010	1.249	4.90	155	2C
	92155	95155	72	SS	.200	.200	1	5	.010	1.249	4.90	155	2C
	13155	53155	144	4140	.200	.200	1	5	.010	1.249	4.90	155	2C
	93155	96155	144	SS	.200	.200	1	5	.010	1.249	4.90	155	2C
1 1/2" - 10	11150	51150	36	4140	.100	.100	1	10	.009	1.355	5.47	150	2C
	12150	52150	72	4140	.100	.100	1	10	.009	1.355	5.47	150	2C
	13150	53150	144	4140	.100	.100	1	10	.009	1.355	5.47	150	2C

POWER • AC™ ACME SCREW ASSEMBLIES

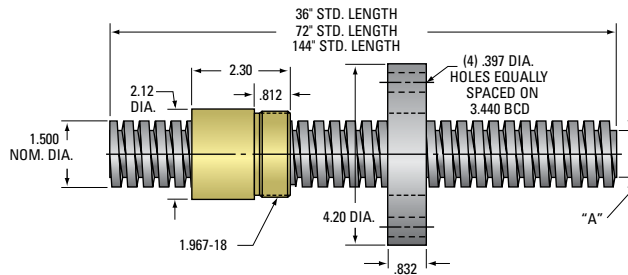

1½" ACME THREAD
Lead Accuracy 0.0003 in/in

		BRONZE NUT						PLASTIC NUT						FLANGE				
	Part Number		% Efficiency	Torque* (in lb)	Load Capacity (lb)		Wt. (lb)	Part Number	Part Number		% Efficiency	Torque* (in lb)	Load Capacity (lb)		Wt. (lb)	Std.	No-Lash™	Wt. (lb)
	RH	LH			Dynamic	Static			RH	LH			Dynamic	Static				
	20152	—	46	.173	11,250	36,000	1.38	30152	—	52	.187	5650	5650	—	FLG7572	73420	3.19	
	20152	—	46	.173	11,250	36,000	1.38	30152	—	52	.187	5650	5650	—	FLG7572	73420	3.19	
	20152	—	46	.173	11,250	36,000	1.38	30152	—	52	.187	5650	5650	—	FLG7572	73420	3.19	
	20153	80153	40	.149	11,250	36,000	1.49	30153	—	46	.161	5650	5650	—	FLG7572	73420	3.19	
	20153	—	40	.149	11,250	36,000	1.49	30153	—	46	.161	5650	5650	—	FLG7572	73420	3.19	
	20153	80153	40	.149	11,250	36,000	1.49	30153	—	46	.161	5650	5650	—	FLG7572	73420	3.19	
	20153	—	40	.149	11,250	36,000	1.49	30153	—	46	.161	5650	5650	—	FLG7572	73420	3.19	
	20153	80153	40	.149	11,250	36,000	1.49	30153	—	46	.161	5650	5650	—	FLG7572	73420	3.19	
	20153	—	40	.149	11,250	36,000	1.49	30153	—	46	.161	5650	5650	—	FLG7572	73420	3.19	
	20154	80154	30	.133	11,250	36,000	1.53	30154	—	36	.145	5650	5650	—	FLG7572	73420	3.19	
	20154	80154	30	.133	11,250	36,000	1.53	30154	—	36	.145	5650	5650	—	FLG7572	73420	3.19	
	20154	80154	30	.133	11,250	36,000	1.53	30154	—	36	.145	5650	5650	—	FLG7572	73420	3.19	
	20154	80154	30	.133	11,250	36,000	1.53	30154	—	36	.145	5650	5650	—	FLG7572	73420	3.19	
	20154	80154	30	.133	11,250	36,000	1.53	30154	—	36	.145	5650	5650	—	FLG7572	73420	3.19	
	20154	80154	30	.133	11,250	36,000	1.53	30154	—	36	.145	5650	5650	—	FLG7572	73420	3.19	
	20155	80155	25	.127	11,250	36,000	1.35	30155	—	31	.139	5650	5650	—	FLG7572	73420	3.19	
	20155	80155	25	.127	11,250	36,000	1.35	30155	—	31	.139	5650	5650	—	FLG7572	73420	3.19	
	20155	80155	25	.127	11,250	36,000	1.35	30155	—	31	.139	5650	5650	—	FLG7572	73420	3.19	
	20155	80155	25	.127	11,250	36,000	1.35	30155	—	31	.139	5650	5650	—	FLG7572	73420	3.19	
	20155	80155	25	.127	11,250	36,000	1.35	30155	—	31	.139	5650	5650	—	FLG7572	73420	3.19	
	20155	80155	25	.127	11,250	36,000	1.35	30155	—	31	.139	5650	5650	—	FLG7572	73420	3.19	
	20150	80150	15	.110	11,250	36,000	1.28	30150	—	21	.126	5650	5650	—	FLG7572	73420	3.19	
	20150	80150	15	.110	11,250	36,000	1.28	30150	—	21	.126	5650	5650	—	FLG7572	73420	3.19	
	20150	80150	15	.110	11,250	36,000	1.28	30150	—	21	.126	5650	5650	—	FLG7572	73420	3.19	

* Torque required to raise 1 lb.

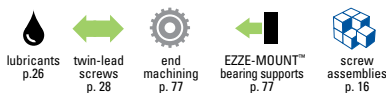

1 3/4 inch diameter
2 inch diameter
2 1/4 inch diameter

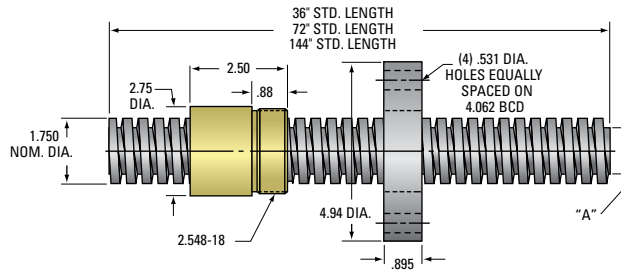

1 3/4" ACME THREAD
 Lead Accuracy 0.0003 in/in

Screw Size	ACME SCREW												
	Part Number RH	Part Number LH	Length (in)	Material	Lead (in)	Pitch (in)	Starts	Threads per in	Lash (max axial)	"A" Dia (in)	Wt. (lb/ft)	Thread Code	Form
1 3/4" - 4	11174	51174	36	4140	.250	.250	1	4	.011	1.427	6.97	174	2C
	12174	52174	72	4140	.250	.250	1	4	.011	1.427	6.97	174	2C
	13174	53174	144	4140	.250	.250	1	4	.011	1.427	6.97	174	2C
2" - 2	11202	—	36	4140	.500	.500	1	2	.020	1.410	8.09	202	40°
	12202	—	72	4140	.500	.500	1	2	.020	1.410	8.09	202	40°
	13202	—	144	4140	.500	.500	1	2	.020	1.410	8.09	202	40°
2" - 4	11204	51204	36	4140	.250	.250	1	4	.012	1.694	9.28	204	2C
	12204	52204	72	4140	.250	.250	1	4	.012	1.694	9.28	204	2C
	13204	53204	144	4140	.250	.250	1	4	.012	1.694	9.28	204	2C
2" - 5	11205	—	36	4140	.200	.200	1	5	.011	1.747	9.53	205	2C
	12205	—	72	4140	.200	.200	1	5	.011	1.747	9.53	205	2C
	13205	—	144	4140	.200	.200	1	5	.011	1.747	9.53	205	2C
2 1/4" - 2	11222	—	36	4140	.500	.500	1	2	.021	1.684	10.58	222	40°
	12222	—	72	4140	.500	.500	1	2	.021	1.684	10.58	222	40°
	13222	—	144	4140	.500	.500	1	2	.021	1.684	10.58	222	40°
2 1/4" - 4	11224	—	36	4140	.250	.250	1	4	.012	1.944	11.29	224	2C
	12224	—	72	4140	.250	.250	1	4	.012	1.944	11.29	224	2C
	13224	—	144	4140	.250	.250	1	4	.012	1.944	11.29	224	2C

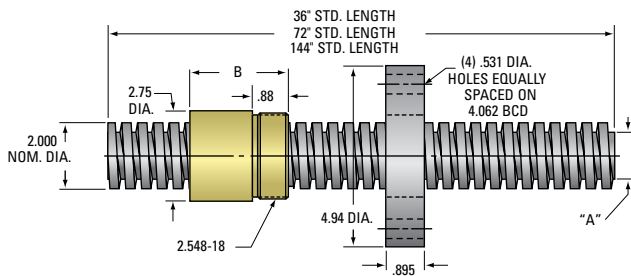

2" ACME THREAD
Lead Accuracy 0.0003 in/in

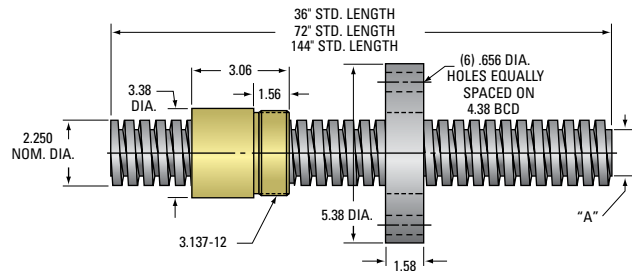

2 1/4" ACME THREAD
Lead Accuracy 0.0003 in/in

		BRONZE NUT						PLASTIC NUT						FLANGE				
	Part Number		% Efficiency	Torque* (in lb)	Load Capacity (lb)		Wt. (lb)	Part Number	Part Number		% Efficiency	Torque* (in lb)	Load Capacity (lb)		Wt. (lb)	Std.		Wt. (lb)
	RH	LH			Dynamic	Static			RH	LH			Dynamic	Static		Std.	No-Lash™	
	20174	80174	26	.153	15,312	49,900	3.05	30174	—	30	.164	7650	7650	—	FLG7573	73500	4.73	
	20174	80174	26	.153	15,312	49,900	3.05	30174	—	30	.164	7650	7650	—	FLG7573	73500	4.73	
	20174	80174	26	.153	15,312	49,900	3.05	30174	—	30	.164	7650	7650	—	FLG7573	73500	4.73	
	20202	—	40	.199	20,000	64,000	2.87	30202	—	40	.214	10,000	10,000	—	FLG7573	73500	4.73	
	20202	—	40	.199	20,000	64,000	2.87	30202	—	40	.214	10,000	10,000	—	FLG7573	73500	4.73	
	20202	—	40	.199	20,000	64,000	2.87	30202	—	40	.214	10,000	10,000	—	FLG7573	73500	4.73	
	20204	80204	24	.166	20,000	64,000	2.59	30204	—	**	**	**	**	—	FLG7573	73500	4.73	
	20204	80204	24	.166	20,000	64,000	2.59	30204	—	**	**	**	**	—	FLG7573	73500	4.73	
	20204	80204	24	.166	20,000	64,000	2.59	30204	—	**	**	**	**	—	FLG7573	73500	4.73	
	20205	—	20	.159	20,000	64,000	2.53	30205	—	**	**	**	**	—	FLG7573	73500	4.73	
	20205	—	20	.159	20,000	64,000	2.53	30205	—	**	**	**	**	—	FLG7573	73500	4.73	
	20205	—	20	.159	20,000	64,000	2.53	30205	—	**	**	**	**	—	FLG7573	73500	4.73	
	20222	—	37	.215	25,312	81,000	5.25	30222	—	**	**	**	**	—	FLG7574	73540	9.88	
	20222	—	37	.215	25,312	81,000	5.25	30222	—	**	**	**	**	—	FLG7574	73540	9.88	
	20222	—	37	.215	25,312	81,000	5.25	30222	—	**	**	**	**	—	FLG7574	73540	9.88	
	20224	—	22	.181	25,312	81,000	4.98	30224	—	**	**	**	**	—	FLG7574	73540	9.88	
	20224	—	22	.181	25,312	81,000	4.98	30224	—	**	**	**	**	—	FLG7574	73540	9.88	
	20224	—	22	.181	25,312	81,000	4.98	30224	—	**	**	**	**	—	FLG7574	73540	9.88	

* Torque required to raise 1 lb.

** Contact our sales engineers.

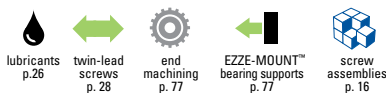

2½ inch diameter
3 inch diameter
3¾ inch diameter

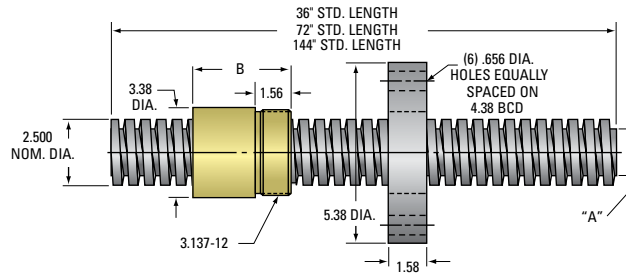

2½" ACME THREAD
 Lead Accuracy 0.0003 in/in

ACME SCREW													
Screw Size	Part Number		Length (in)	Material	Lead (in)	Pitch (in)	Starts	Threads per in	Lash (max axial)	"A" Dia (in)	Wt. (lb/ft)	Thread Code	Form
	RH	LH											
2½" - 2 (see table below for nut body length)	11252	—	36	4140	.500	.500	1	2	.012	1.908	13.41	252	40°
	12252	—	72	4140	.500	.500	1	2	.012	1.908	13.41	252	40°
	13252	—	144	4140	.500	.500	1	2	.012	1.908	13.41	252	40°
2½" - 3 (see table below for nut body length)	11253	—	36	4140	.333	.333	1	3	.013	2.106	14.38	253	2C
	12253	—	72	4140	.333	.333	1	3	.013	2.106	14.38	253	2C
	13253	—	144	4140	.333	.333	1	3	.013	2.106	14.38	253	2C
2½" - 4 (see table below for nut body length)	11254	—	36	4140	.250	.250	1	4	.012	2.193	14.89	254	2C
	12254	—	72	4140	.250	.250	1	4	.012	2.193	14.89	254	2C
	13254	—	144	4140	.250	.250	1	4	.012	2.193	14.89	254	2C
3" - 2	12302	—	72	4140	.500	.500	1	2	.016	2.410	19.96	302	2C
	13302	—	144	4140	.500	.500	1	2	.016	2.410	19.96	302	2C
	10302	—	240	4140	.500	.500	1	2	.016	2.410	19.96	302	2C
3¾" - 1½	12332	—	72	4140	.667	.667	1	1½	.020	2.652	20.15	332	2G
	13332	—	144	4140	.667	.667	1	1½	.020	2.652	20.15	332	2G
	10332	—	240	4140	.667	.667	1	1½	.020	2.652	20.15	332	2G

"B" NUT BODY LENGTH	
2½" - 2	3.38
2½" - 3	4.25
2½" - 4	3.38

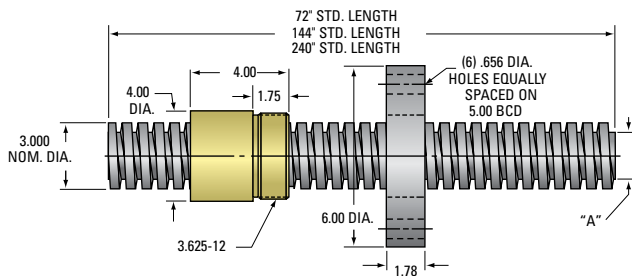

3" ACME THREAD
Lead Accuracy 0.0006 in/in

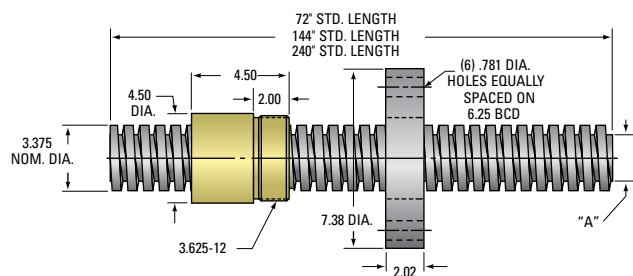

3/8" ACME THREAD
Lead Accuracy 0.0006 in/in

		BRONZE NUT					PLASTIC NUT					FLANGE						
Part Number	RH	LH	% Efficiency	Torque* (in lb)	Load Capacity (lb)		Wt. (lb)	Part Number	RH	LH	% Efficiency	Torque* (in lb)	Load Capacity (lb)		Wt. (lb)	Std.	No-Lash™	Wt. (lb)
					Dynamic	Static							Dynamic	Static				
20252		—	34	.234	31,250	100,000	5.00	**	**	**	**	**	**	**	FLG7574	73540	9.88	
20252		—	34	.234	31,250	100,000	5.00	**	**	**	**	**	**	**	FLG7574	73540	9.88	
20252		—	34	.234	31,250	100,000	5.00	**	**	**	**	**	**	**	FLG7574	73540	9.88	
20253		—	25	.215	31,250	100,000	5.91	**	**	**	**	**	**	**	FLG7574	73540	9.88	
20253		—	25	.215	31,250	100,000	5.91	**	**	**	**	**	**	**	FLG7574	73540	9.88	
20253		—	25	.215	31,250	100,000	5.91	**	**	**	**	**	**	**	FLG7574	73540	9.88	
20254		—	20	.199	31,250	100,000	4.55	**	**	**	**	**	**	**	FLG7574	73540	9.88	
20254		—	20	.199	31,250	100,000	4.55	**	**	**	**	**	**	**	FLG7574	73540	9.88	
20254		—	20	.199	31,250	100,000	4.55	**	**	**	**	**	**	**	FLG7574	73540	9.88	
20302		—	30	.265	45,000	144,000	7.85	**	**	**	**	**	**	**	70600	73302	13.83	
20302		—	30	.265	45,000	144,000	7.85	**	**	**	**	**	**	**	70600	73302	13.83	
20302		—	30	.265	45,000	144,000	7.85	**	**	**	**	**	**	**	70600	73302	13.83	
20332		—	34	.312	60,000	192,000	11.62	**	**	**	**	**	**	**	70740	73332	11.62	
20332		—	34	.312	60,000	192,000	11.62	**	**	**	**	**	**	**	70740	73332	11.62	
20332		—	34	.312	60,000	192,000	11.62	**	**	**	**	**	**	**	70740	73332	11.62	

* Torque required to raise 1 lb.
** Contact our sales engineers.

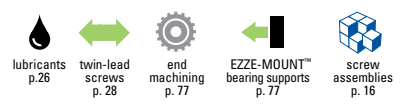

3¾ inch diameter
4½ inch diameter
5 inch diameter
6 inch diameter

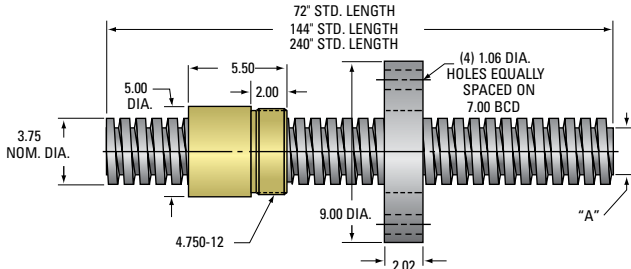

3¾" ACME THREAD
 Lead Accuracy 0.0006 in/in

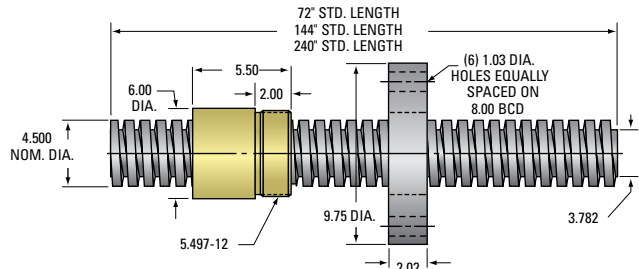

4½" ACME THREAD
 Lead Accuracy 0.0006 in/in

Screw Size	ACME SCREW												
	Part Number RH	Part Number LH	Length (in)	Material	Lead (in)	Pitch (in)	Starts	Threads per in	Lash (max axial)	"A" Dia (in)	Wt. (lb/ft)	Thread Code	Form
3¾" – 1½"	12372	—	72	4140	.667	.667	1	1½	.020	3.009	38.30	372	2G
	13372	—	144	4140	.667	.667	1	1½	.020	3.009	38.30	372	2G
	10372	—	240	4140	.667	.667	1	1½	.020	3.009	38.30	372	2G
4½" – 1½"	12452	—	72	4140	.667	.667	1	1½	.022	3.782	45.00	452	2G
	13452	—	144	4140	.667	.667	1	1½	.022	3.782	45.00	452	2G
	10452	—	240	4140	.667	.667	1	1½	.022	3.782	45.00	452	2G
5" – 1½"	12552	—	72	4140	.667	.667	1	1½	.022	4.286	57.50	552	2G
	13552	—	144	4140	.667	.667	1	1½	.022	4.286	57.50	552	2G
	10552	—	240	4140	.667	.667	1	1½	.022	4.286	57.50	552	2G
6" – 1½"	12602	—	72	4140	.667	.667	1	1½	.025	5.254	87	602	2G
	13602	—	144	4140	.667	.667	1	1½	.025	5.254	87	602	2G
	10602	—	240	4140	.667	.667	1	1½	.025	5.254	87	602	2G

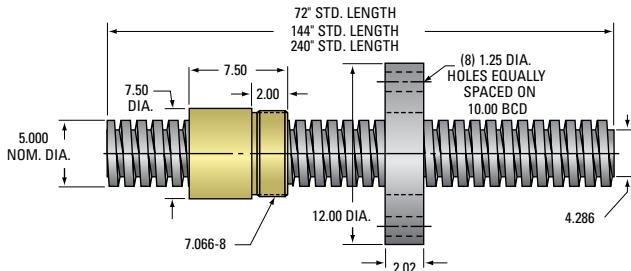

5" ACME THREAD
Lead Accuracy 0.0006 in/in

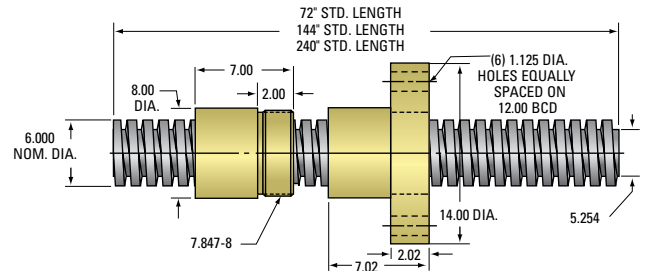

6" ACME THREAD
Lead Accuracy 0.0006 in/in

	BRONZE NUT						BRONZE NUT WITH INTEGRAL FLANGE						FLANGE		
	Part Number RH LH	% Efficiency	Torque* (in lb)	Load Capacity (lb) Dynamic Static	Wt. (lb)		Part Number RH LH	% Efficiency	Torque* (in lb)	Load Capacity (lb) Dynamic Static	Wt. (lb)		Std.	No-Lash™	Wt. (lb)
	20372 —	30	.345	81,000 260,000	16.89		** **	** **	** **	** **	** **		70775	73372	23.82
	20372 —	30	.345	81,000 260,000	16.89		** **	** **	** **	** **	** **		70775	73372	23.82
	20372 —	30	.345	81,000 260,000	16.89		** **	** **	** **	** **	** **		70775	73372	23.82
	20452 —	28	.379	100,000 320,000	25.85		** **	** **	** **	** **	** **		FLG3307	73452	26.00
	20452 —	28	.379	100,000 320,000	25.85		** **	** **	** **	** **	** **		FLG3307	73452	26.00
	20452 —	28	.379	100,000 320,000	25.85		** **	** **	** **	** **	** **		FLG3307	73452	26.00
	20552 —	26	.398	145,000 470,000	60.59		** **	** **	** **	** **	** **		75000	73552	38.00
	20552 —	26	.398	145,000 470,000	60.59		** **	** **	** **	** **	** **		75000	73552	38.00
	20552 —	26	.398	145,000 470,000	60.59		** **	** **	** **	** **	** **		75000	73552	38.00
	20602 —	22	.474	180,000 567,000	52.5		6954-1 —	22	.474	180,000 567,000	100		—	—	—
	20602 —	22	.474	180,000 567,000	52.5		6954-1 —	22	.474	180,000 567,000	100		—	—	—
	20602 —	22	.474	180,000 567,000	52.5		6954-1 —	22	.474	180,000 567,000	100		—	—	—

* Torque required to raise 1 lb.
** Contact our sales engineers.



TRAPEZOIDAL LEAD SCREW ASSEMBLIES

With over forty years of experience manufacturing precision Acme screws, Helix has expanded the PowerAc™ offering to include metric lead screws providing design engineers a globally accepted product. Trapezoidal lead screws are available in many diameters, leads, and pitches. Trapezoidal screws use bronze or plastic nuts with optional steel flanges.

TRAPEZOIDAL SCREW AND NUT

Similar in construction and materials to PowerAc Inch Acme Screws and Nuts, the Trapezoidal thread form has been enhanced to include a centralizing thread form to prevent wedging and binding. See the PowerAc technical data on pages 2-9 for additional screw and nut details.

Standard lead accuracy: $\pm 6.25\mu\text{m} / 25\text{mm}$
 Temperature Range: Plastic Nuts: -9° to $+79^\circ\text{C}$
 Bronze Nuts: -9° to $+177^\circ\text{C}$



Stainless steel trapezoidal screw assemblies with bronze nuts

QUICK REFERENCE: TRAPEZOIDAL SCREWS AND NUTS

NUT SELECTION

Screw Sizes	Pitch (mm)	Lead (mm)	Starts	Root Dia. (mm)	BRONZE			PLASTIC			Page ref
					Dynamic Load Rating (N)	Torque to Raise 1 kN (N-m)	Efficiency %	Dynamic Load Rating (N)	Torque to Raise 1 kN (N-m)	Efficiency %	
Tr 8 x 1.5	1.5	1.5	1	6.10	2224	.952	25	1300	.569	46	60
Tr 8 x 4	2	4	2	6.70	2224	1.45	44	1300	.950	54	60
Tr 8 x 8	2	8	4	5.30	2224	2.12	57	1300	2.12	80	60
Tr 10 x 2	2	2	1	7.04	2980	1.22	26	1490	.680	47	62
Tr 10 x 3(1.5)	1.5	3	2	7.92	3447	1.090	44	1490	.966	49	62
Tr 10 x 9	3	9	3	8.10	3447	2.530	63	1490	1.85	77	62
Tr 11 x 6	3	6	2	7.30	4101	1.99	48	2071	1.36	70	62
Tr 12 x 3	3	3	1	7.69	4963	1.119	33	2481	.989	48	64
Tr 12 x 6	3	6	2	7.80	5218	2.06	46	2612	1.39	69	64
Tr 12 x 10	2.5	10	4	8.80	5218	2.84	56	2612	2.05	77	64
Tr 14 x 3	3	3	1	10.30	6543	1.76	27	3700	1.13	48	66
Tr 14 x 4	4	4	1	9.30	6543	1.89	34	3700	1.13	56	66
Tr 16 x 2	2	2	1	13.30	8825	1.85	17	4412	.93	34	68
Tr 16 x 4	4	4	1	10.90	8825	1.560	41	4412	1.374	46	68
Tr 16 x 6	3	6	2	11.40	8825	2.44	39	4412	1.54	62	68
Tr 16 x 8	4	8	2	10.90	8825	2.80	46	4412	1.87	68	68
Tr 18 x 4	4	4	1	13.10	10675	2.29	28	5337	1.29	49	70
Tr 20 x 4	4	4	1	14.90	13790	1.818	35	6895	1.580	40	70
Tr 20 x 8	4	8	2	15.10	13790	3.19	40	6895	2.02	63	70
Tr 26 x 6	6	6	1	17.84	23304	2.469	39	11652	2.164	44	72
Tr 40 x 7	7	7	1	30.95	55160	3.503	32	5516	3.022	37	72
Tr 55 x 12	12	12	1	40.00	104287	5.131	37	**	**	**	74
Tr 65 x 12	12	12	1	50.02	145651	5.775	33	**	**	**	74

** Contact our sales engineers.

TRAPEZOIDAL SCREW ASSEMBLIES REFERENCE NUMBER SYSTEM



904 - RA / EK / 4N / 1063 / 20904 / FS

LEAD SCREW

Thread Form Codes

ISO	Dia. x Lead	ISO	Dia. x Lead	ISO	Dia. x Lead
896	= 8 x 1.5	910	= 12 x 6	917	= 18 x 4
897	= 8 x 4	911	= 12 x 10	903	= 20 x 4
898	= 8 x 8	912	= 14 x 3	918	= 20 x 8
899	= 10 x 2	913	= 14 x 4	904	= 26 x 6
900	= 10 x 3 (1.5)	914	= 16 x 2	905	= 40 x 7
908	= 10 x 9	902	= 16 x 4	906	= 55 x 12
909	= 11 x 6	915	= 16 x 6	907	= 65 x 12
901	= 12 x 3	916	= 16 x 8		

MATERIAL

R A

R = Right Hand Thread

- A = Alloy Steel
- B = Alloy Steel, Milled
- C = Alloy Steel, Ground
- S = Stainless Steel, Rolled
- T = Stainless Steel, Milled
- U = Stainless Steel, Ground

Note: Not all materials are available for all sizes.

FIRST END CONFIGURATION

Note: Both Ends must be specified.

Single Bearing Supports are used in conjunction with Type 1N end machining.

Double Bearing Supports are used in conjunction with Type 3K, 3L, or 3N end machining.

Flanged Fixed Bearing Mounts are used in conjunction with Type 5 end machining.

EZZE-MOUNT™ / End Machining (see pages 82-85)

- 1 = Type 1 3 = Type 3
- 2 = Type 2 4 = Type 4
- 5 = Type 5

B = Universal Double Bearing Support
End Cap Facing Screw Thread

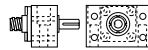

C = Universal Single Bearing Support



D = Flanged Single Bearing Support
Flange Facing Screw Thread



E = Universal Double Bearing Support End
Cap Facing Away From Screw Thread

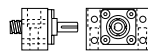

F = Flanged Double Bearing Support
Flange Facing Screw Thread

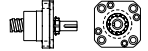

G = Flanged Single Bearing Support Flange
Facing Away From Screw Thread



H = Flanged Double Bearing Support Flange
Facing Away From Screw Thread

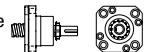

lubricants p. 26
twin-lead screws p. 28
end machining p. 77
EZZE-MOUNT™ end bearing supports p. 77
screw assemblies p. 16

EK EK = Universal Double
Bearing Support,
with Keyway

Shaft Extension (see pages 82-84)

- K = Shaft Extension with Keyway
- L = Shaft Extension without Keyway
- N = No Shaft
- Q = Handwheel

MODIFIER LIST

- S or M Required
- F Optional
 - S = Standard, not additional description required
 - F = Round Flange
 - M = Modified, additional description required

TRAVEL NUT

Nut will be installed with flange or threaded end toward first end designation. 000000 = No Nut

Use standard part number found in the Technical Data Section for Metric ISO Trapezoidal Screws.

Example: 20904 = 26 x 6 ISO Trapezoidal Nut

OVERALL LENGTH (OAL)

Length in mm.

SECOND END CONFIGURATION

Refer to the First End Configuration section below

Note: Both Ends must be specified.

COLUMN STRENGTH: TRAPEZOIDAL SCREWS

Metric Screws are limited by both Maximum Static Load and Slenderness Ratio. See pages 12-13 for reference description on A-B-C-D end fixity.

Metric to Inch Conversion: 1 Newton = .224 lbf 1mm = 0.039 in 1 N m = 8.85 in lb

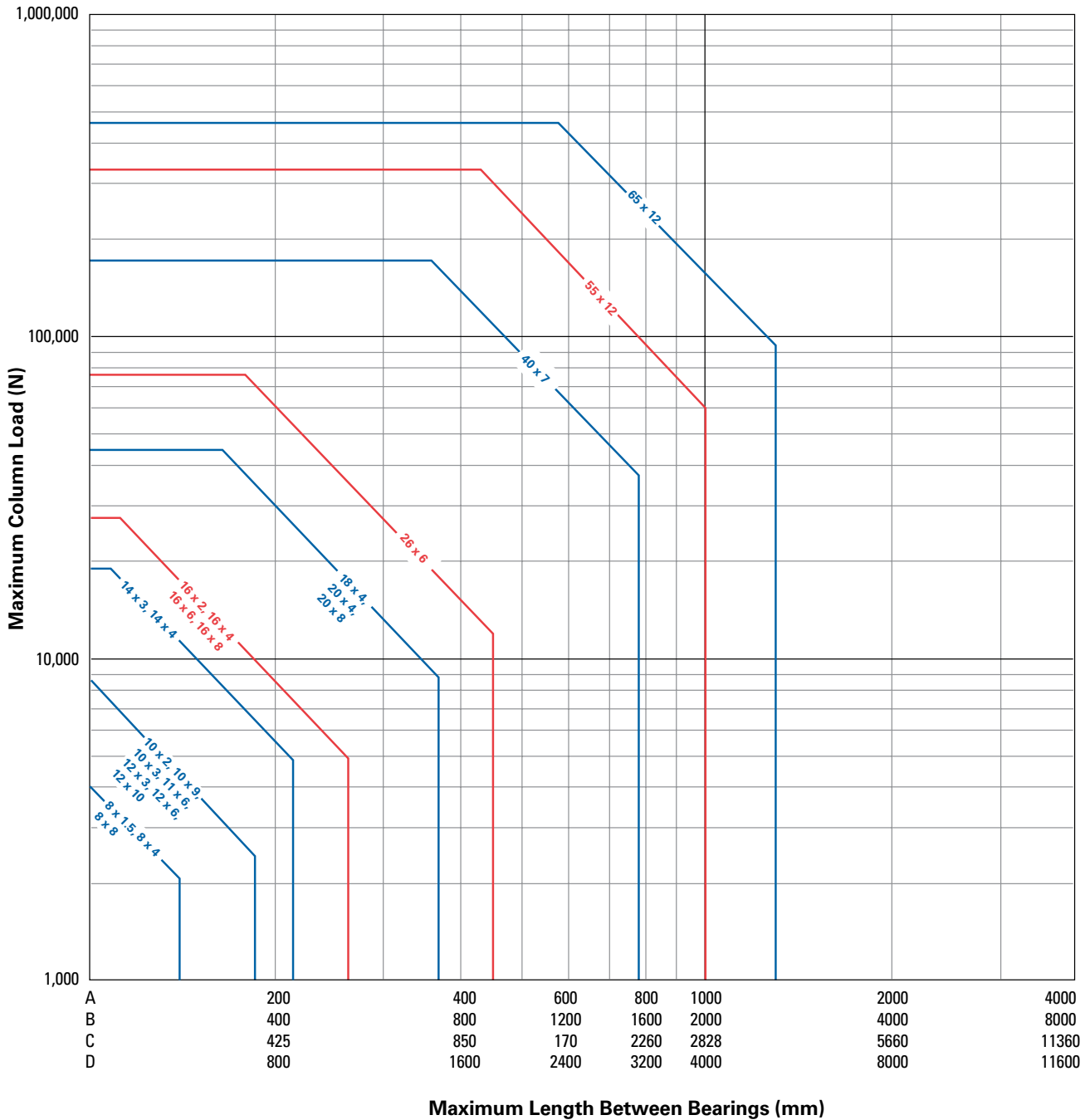

CRITICAL SPEED: TRAPEZOIDAL SCREWS

Curves are alternately broken and solid for ease of use. The line type has no significance.

NOTE: Maximum Speed is limited to 80% of the calculated Critical Speed. See pages 12-13 for reference description on A-B-C-D end fixity.

Metric to Inch Conversion: 1 Newton = .224 lbf 1mm = 0.039 in 1 N m = 8.85 in lb

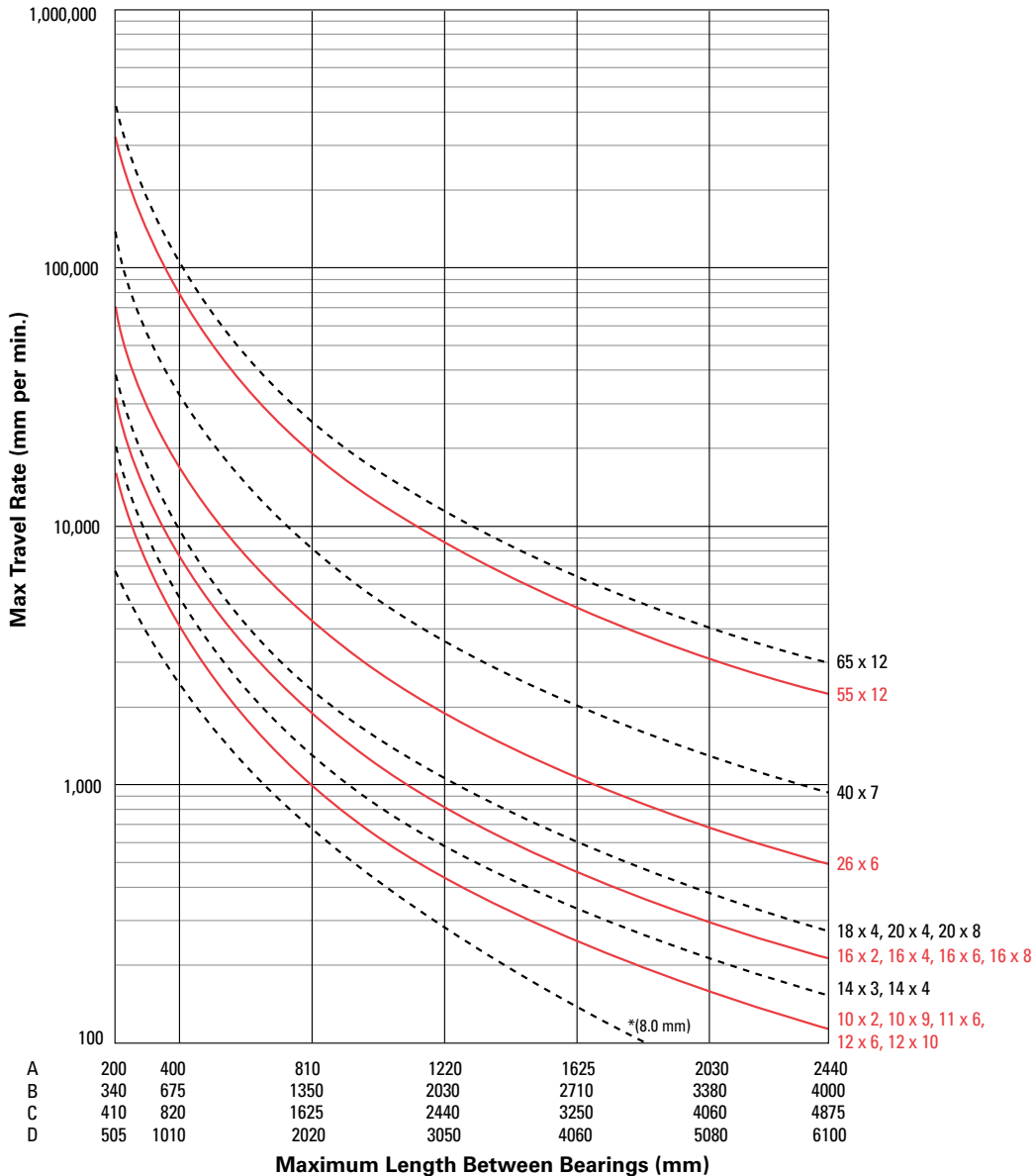

*8 x 1.5, 8 x 4, 8 x 8

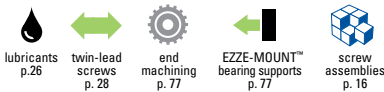

8mm diameter

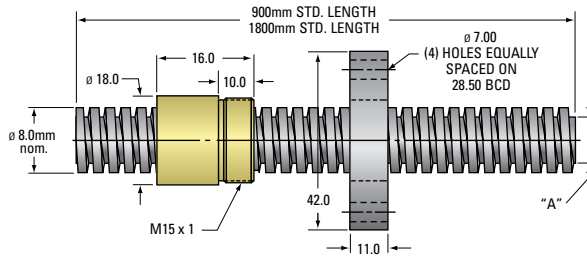

8mm Trapezoidal Thread
Lead Accuracy $\pm 6.25 \mu\text{m}/25\text{mm}$

TRAPEZOIDAL SCREW												
Dia × Lead	Part Number		Length (mm)	Material	Pitch (mm)	Starts	Dia (mm)	"A" Dia. (mm)	Thread Code	Wt. (kg/m)	Lash (mm)	
	RH	LH										
Tr 8x1.5	14896	—	900	4140	1.5	1	8	6.10	896	0.4	0.11	
	54896	—	900	SS	1.5	1	8	6.10	896	0.4	0.11	
	15896	—	1800	4140	1.5	1	8	6.10	896	0.4	0.11	
	55896	—	1800	SS	1.5	1	8	6.10	896	0.4	0.11	
Tr 8x4	14897	—	900	4140	4	2	8	6.70	897	0.4	0.11	
	54897	—	900	SS	4	2	8	6.70	897	0.4	0.11	
	15897	—	1800	4140	4	2	8	6.70	897	0.4	0.11	
	55897	—	1800	SS	4	2	8	6.70	897	0.4	0.11	
Tr 8x8	14898	—	900	4140	8	4	8	5.30	898	0.4	0.11	
	54898	—	900	SS	8	4	8	5.30	898	0.4	0.11	
	15898	—	1800	4140	8	4	8	5.30	898	0.4	0.11	
	55898	—	1800	SS	8	4	8	5.30	898	0.4	0.11	

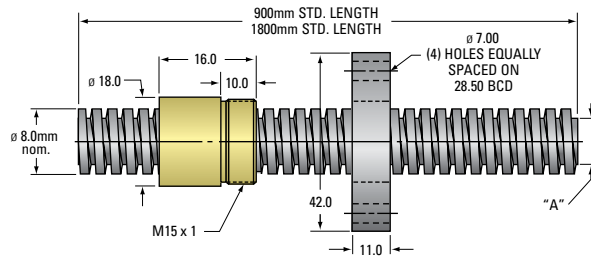

8mm Trapezoidal Thread
Lead Accuracy $\pm 6.25 \mu\text{m}/25\text{mm}$

	BRONZE NUT						PLASTIC NUT						FLANGE	
	Part Number RH	% Efficiency	Torque to Raise 1 kN (N-m)	Wt. (g)	Load capacity (N)		Part Number RH	% Efficiency	Torque to Raise 1 kN (N-m)	Wt. g.	Load capacity (N)		Part Number	Wt. (kg)
					Dynamic	Static					Dynamic	Static		
	20896	22	.952	22	3,127	10,008	30896	32	.569	4.5	1,433	1,433	72001	.23
	20896	22	.952	22	3,127	10,008	30896	32	.569	4.5	1,433	1,433	72001	.23
	20896	22	.952	22	3,127	10,008	30896	32	.569	4.5	1,433	1,433	72001	.23
	20896	22	.952	22	3,127	10,008	30896	32	.569	4.5	1,433	1,433	72001	.23
	20897	44	1.389	22	3,127	10,008	30897	54	.978	4.5	1,433	1,433	72001	.23
	20897	44	1.389	22	3,127	10,008	30897	54	.978	4.5	1,433	1,433	72001	.23
	20897	44	1.389	22	3,127	10,008	30897	54	.978	4.5	1,433	1,433	72001	.23
	20897	44	1.389	22	3,127	10,008	30897	54	.978	4.5	1,433	1,433	72001	.23
	20898	57	2.131	22	3,127	10,008	30898	67	1.653	4.5	1,433	1,433	72001	.23
	20898	57	2.131	22	3,127	10,008	30898	67	1.653	4.5	1,433	1,433	72001	.23
	20898	57	2.131	22	3,127	10,008	30898	67	1.653	4.5	1,433	1,433	72001	.23
	20898	57	2.131	22	3,127	10,008	30898	67	1.653	4.5	1,433	1,433	72001	.23

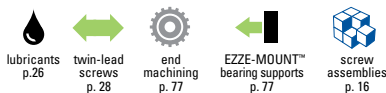

10mm diameter
11mm diameter

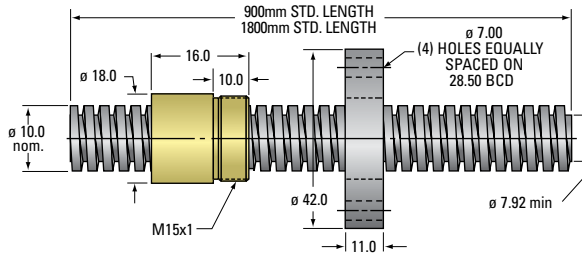

10mm Trapezoidal Thread
Lead Accuracy $\pm 6.25 \mu\text{m}/25\text{mm}$

TRAPEZOIDAL SCREW											
Dia x Lead	Part Number		Length (mm)	Material	Pitch (mm)	Starts	Dia (mm)	"A" Dia. (mm)	Thread Code	Wt. (kg/m)	Lash (mm)
	RH	LH									
Tr 10x2	14899	—	900	4140	2	1	10	7.04	899	0.5	0.13
	54899	—	900	SS	2	1	10	7.04	899	0.5	0.13
	15899	—	1800	4140	2	1	10	7.04	899	0.5	0.13
	55899	—	1800	SS	2	1	10	7.04	899	0.5	0.13
Tr 10x3 (1.5)	14900	—	900	4140	1.5	2	10	7.92	900	0.5	0.13
	54900	—	900	SS	1.5	2	10	7.92	900	0.5	0.13
	15900	—	1800	4140	1.5	2	10	7.92	900	0.5	0.13
	55900	—	1800	SS	1.5	2	10	7.92	900	0.5	0.13
Tr 10x9	14908	—	900	4140	9	3	10	8.10	908	0.5	0.13
	54908	—	900	SS	9	3	10	8.10	908	0.5	0.13
	15908	—	1800	4140	9	3	10	8.10	908	0.5	0.13
	55908	—	1800	SS	9	3	10	8.10	908	0.5	0.13
Tr 11x6	14909	—	900	4140	6	2	11	7.30	909	0.6	0.14
	54909	—	900	SS	6	2	11	7.30	909	0.6	0.14
	15909	—	1800	4140	6	2	11	7.30	909	0.6	0.14
	55909	—	1800	SS	6	2	11	7.30	909	0.6	0.14

POWER • AC™ TRAPEZOIDAL SCREW ASSEMBLIES

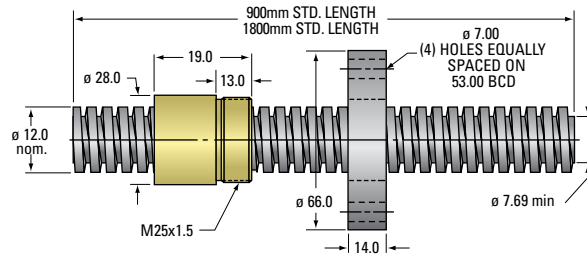

11mm Trapezoidal Thread
Lead Accuracy $\pm 6.25 \mu\text{m}/25\text{mm}$

	BRONZE NUT						PLASTIC NUT						FLANGE	
	Part Number RH	% Efficiency	Torque to Raise 1 kN (N-m)	Wt. (g)	Load capacity (N) Dynamic Static		Part Number RH	% Efficiency	Torque to Raise 1 kN (N-m)	Wt. g.	Load capacity (N) Dynamic Static		Part Number	Wt. (kg)
	20899	31	1.269	25	3,447	11,032	30899	46	1.028	4.5	1,723	1,723	72001	.23
	20899	31	1.269	25	3,447	11,032	30899	46	1.028	4.5	1,723	1,723	72001	.23
	20899	31	1.269	25	3,447	11,032	30899	46	1.028	4.5	1,723	1,723	72001	.23
	20899	31	1.269	25	3,447	11,032	30899	46	1.028	4.5	1,723	1,723	72001	.23
	20900	44	1.441	25	3,447	11,032	30900	49	1.196	4.5	1,723	1,723	72001	.23
	20900	44	1.441	25	3,447	11,032	30900	49	1.196	4.5	1,723	1,723	72001	.23
	20900	44	1.441	25	3,447	11,032	30900	49	1.196	4.5	1,723	1,723	72001	.23
	20900	44	1.441	25	3,447	11,032	30900	49	1.196	4.5	1,723	1,723	72001	.23
	20908	63	2.526	25	3,447	11,032	30908	77	2.239	4.5	1,723	1,723	72001	.23
	20908	63	2.526	25	3,447	11,032	30908	77	2.239	4.5	1,723	1,723	72001	.23
	20908	63	2.526	25	3,447	11,032	30908	77	2.239	4.5	1,723	1,723	72001	.23
	20908	63	2.526	25	3,447	11,032	30908	77	2.239	4.5	1,723	1,723	72001	.23
	20909	48	2.046	84	4,205	13,445	30909	69	1.765	15	2,100	2,100	72002	.31
	20909	48	2.046	84	4,205	13,445	30909	69	1.765	15	2,100	2,100	72002	.31
	20909	48	2.046	84	4,205	13,445	30909	69	1.765	15	2,100	2,100	72002	.31
	20909	48	2.046	84	4,205	13,445	30909	69	1.765	15	2,100	2,100	72002	.31

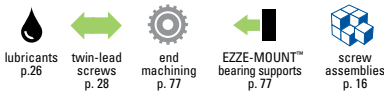

12mm diameter

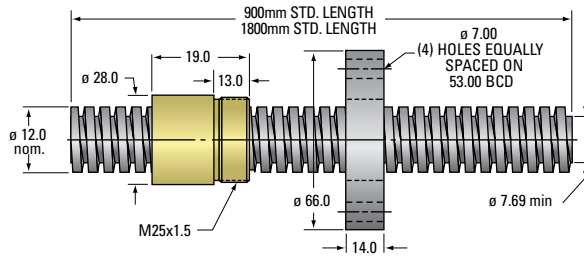

12mm Trapezoidal Thread
Lead Accuracy $\pm 6.25 \mu\text{m}/25\text{mm}$

TRAPEZOIDAL SCREW											
Dia x Lead	Part Number		Length (mm)	Material	Pitch (mm)	Starts	Dia (mm)	"A" Dia. (mm)	Thread Code	Wt. (kg/m)	Lash (mm)
	RH	LH									
Tr 12x3	14901	—	900	4140	3	1	12	7.69	901	0.7	0.16
	54901	—	900	SS	3	1	12	7.69	901	0.7	0.16
	15901	—	1800	4140	3	1	12	7.69	901	0.7	0.16
	55901	—	1800	SS	3	1	12	7.69	901	0.7	0.16
Tr 12x6	14910	—	900	4140	6	2	12	7.80	910	0.7	0.16
	54910	—	900	SS	6	2	12	7.80	910	0.7	0.16
	15910	—	1800	4140	6	2	12	7.80	910	0.7	0.16
	55910	—	1800	SS	6	2	12	7.80	910	0.7	0.16
Tr 12x10	14911	—	900	4140	10	4	12	8.80	911	0.7	0.16
	54911	—	900	SS	10	4	12	8.80	911	0.7	0.16
	15911	—	1800	4140	10	4	12	8.80	911	0.7	0.16
	55911	—	1800	SS	10	4	12	8.80	911	0.7	0.16

POWER • AC™ TRAPEZOIDAL SCREW ASSEMBLIES

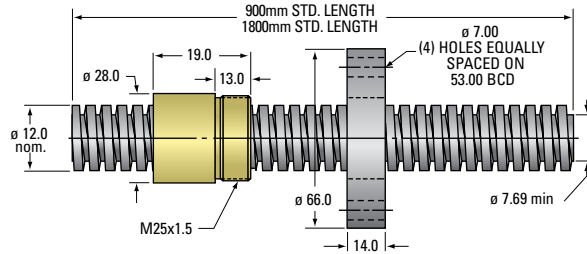

12mm Trapezoidal Thread
Lead Accuracy $\pm 6.25 \mu\text{m}/25\text{mm}$

	BRONZE NUT						PLASTIC NUT						FLANGE	
	Part Number RH	% Efficiency	Torque to Raise 1 kN (N-m)	Wt. (g)	Load capacity (N) Dynamic Static		Part Number RH	% Efficiency	Torque to Raise 1 kN (N-m)	Wt. g.	Load capacity (N) Dynamic Static		Part Number	Wt. (kg)
	20901	33	1.523	84	4,963	15,858	30901	48	1.259	15	2,481	2,481	72002	.31
	20901	33	1.523	84	4,963	15,858	30901	48	1.259	15	2,481	2,481	72002	.31
	20901	33	1.523	84	4,963	15,858	30901	48	1.259	15	2,481	2,481	72002	.31
	20901	33	1.523	84	4,963	15,858	30901	48	1.259	15	2,481	2,481	72002	.31
	20910	52	2.051	84	4,963	15,858	30910	65	1.769	15	2,481	2,481	72002	.31
	20910	52	2.051	84	4,963	15,858	30910	65	1.769	15	2,481	2,481	72002	.31
	20910	52	2.051	84	4,963	15,858	30910	65	1.769	15	2,481	2,481	72002	.31
	20910	52	2.051	84	4,963	15,858	30910	65	1.769	15	2,481	2,481	72002	.31
	20911	63	2.788	84	4,963	15,858	30911	74	2.473	15	2,481	2,481	72002	.31
	20911	63	2.788	84	4,963	15,858	30911	74	2.473	15	2,481	2,481	72002	.31
	20911	63	2.788	84	4,963	15,858	30911	74	2.473	15	2,481	2,481	72002	.31
	20911	63	2.788	84	4,963	15,858	30911	74	2.473	15	2,481	2,481	72002	.31

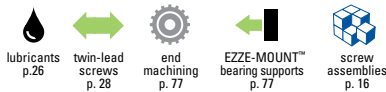

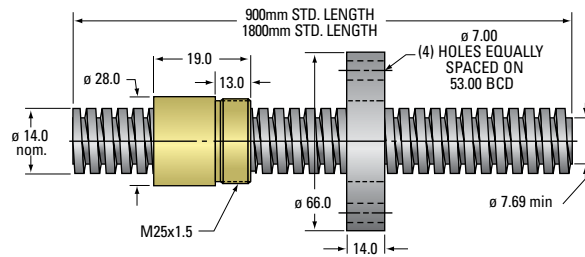

14mm Trapezoidal Thread
Lead Accuracy $\pm 6.25 \mu\text{m}/25\text{mm}$

	BRONZE NUT						PLASTIC NUT						FLANGE	
	Part Number RH	% Efficiency	Torque to Raise 1 kN (N-m)	Wt. (g)	Load capacity (N) Dynamic Static		Part Number RH	% Efficiency	Torque to Raise 1 kN (N-m)	Wt. g.	Load capacity (N) Dynamic Static		Part Number	Wt. (kg)
	20912	32	1.800	92	6,800	2,100	30912	46	1.466	13.6	3,300	3,300	72002	.31
	20912	32	1.800	92	6,800	2,100	30912	46	1.466	13.6	3,300	3,300	72002	.31
	20912	32	1.800	92	6,800	2,100	30912	46	1.466	13.6	3,300	3,300	72002	.31
	20912	32	1.800	92	6,800	2,100	30912	46	1.466	13.6	3,300	3,300	72002	.31
	20913	41	1.972	92	6,800	2,100	30913	53	1.633	13.6	3,300	3,300	72002	.31
	20913	41	1.972	92	6,800	2,100	30913	53	1.633	13.6	3,300	3,300	72002	.31
	20913	41	1.972	92	6,800	2,100	30913	53	1.633	13.6	3,300	3,300	72002	.31
	20913	41	1.972	92	6,800	2,100	30913	53	1.633	13.6	3,300	3,300	72002	.31

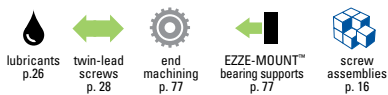

16mm diameter

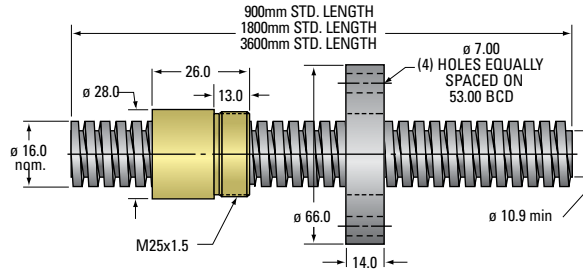

16mm Trapezoidal Thread
Lead Accuracy $\pm 6.25 \mu\text{m}/25\text{mm}$

TRAPEZOIDAL SCREW											
Dia x Lead	Part Number		Length (mm)	Material	Pitch (mm)	Starts	Dia (mm)	"A" Dia. (mm)	Thread Code	Wt. (kg/m)	Lash (mm)
	RH	LH									
Tr 16x2	14914	—	900	4140	2	1	16	13.30	914	1.21	0.24
	54914	—	900	SS	2	1	16	13.30	914	1.21	0.24
	15914	—	1800	4140	2	1	16	13.30	914	1.21	0.24
	55914	—	1800	SS	2	1	16	13.30	914	1.21	0.24
Tr 16x4	14902	—	900	4140	4	1	16	10.90	902	1.21	0.24
	54902	—	900	SS	4	1	16	10.90	902	1.21	0.24
	15902	—	1800	4140	4	1	16	10.90	902	1.21	0.24
	55902	—	1800	SS	4	1	16	10.90	902	1.21	0.24
	16902	—	3600	4140	4	1	16	10.90	902	1.21	0.24
	56902	—	3600	SS	4	1	16	10.90	902	1.21	0.24
Tr 16x6	14915	—	900	4140	6	2	16	11.40	915	1.21	0.24
	54915	—	900	SS	6	2	16	11.40	915	1.21	0.24
	15915	—	1800	4140	6	2	16	11.40	915	1.21	0.24
	55915	—	1800	SS	6	2	16	11.40	915	1.21	0.24
Tr 16x8	14916	—	900	4140	8	2	16	10.90	916	1.21	0.24
	54916	—	900	SS	8	2	16	10.90	916	1.21	0.24
	15916	—	1800	4140	8	2	16	10.90	916	1.21	0.24
	55916	—	1800	SS	8	2	16	10.90	916	1.21	0.24

POWER • AC™ TRAPEZOIDAL SCREW ASSEMBLIES

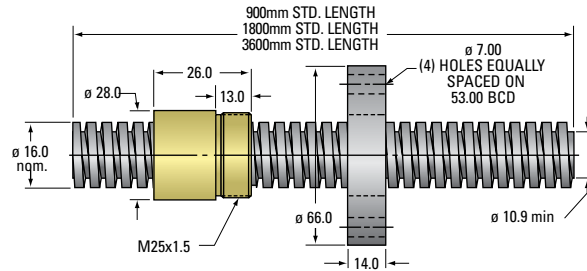

16mm Trapezoidal Thread
Lead Accuracy $\pm 6.25 \mu\text{m}/25\text{mm}$

	BRONZE NUT						PLASTIC NUT						FLANGE	
	Part Number RH	% Efficiency	Torque to Raise 1 kN (N-m)	Wt. (g)	Load capacity (N)		Part Number RH	% Efficiency	Torque to Raise 1 kN (N-m)	Wt. g.	Load capacity (N)		Part Number	Wt. (kg)
					Dynamic	Static					Dynamic	Static		
	20914	23	1.728	100	8,825	28,240	30914	33	1.373	18	4,400	4,400	72002	.31
	20914	23	1.728	100	8,825	28,240	30914	33	1.373	18	4,400	4,400	72002	.31
	20914	23	1.728	100	8,825	28,240	30914	33	1.373	18	4,400	4,400	72002	.31
	20914	23	1.728	100	8,825	28,240	30914	33	1.373	18	4,400	4,400	72002	.31
	20902	41	2.070	100	8,825	28,240	30902	46	1.706	18	4,412	4,412	72002	.31
	20902	41	2.070	100	8,825	28,240	30902	46	1.706	18	4,412	4,412	72002	.31
	20902	41	2.070	100	8,825	28,240	30902	46	1.706	18	4,412	4,412	72002	.31
	20902	41	2.070	100	8,825	28,240	30902	46	1.706	18	4,412	4,412	72002	.31
	20902	41	2.070	100	8,825	28,240	30902	46	1.706	18	4,412	4,412	72002	.31
	20915	48	2.418	100	8,825	28,240	30915	59	2.044	18	4,400	4,400	72002	.31
	20915	48	2.418	100	8,825	28,240	30915	59	2.044	18	4,400	4,400	72002	.31
	20915	48	2.418	100	8,825	28,240	30915	59	2.044	18	4,400	4,400	72002	.31
	20915	48	2.418	100	8,825	28,240	30915	59	2.044	18	4,400	4,400	72002	.31
	20916	52	2.773	100	8,825	28,240	30916	65	2.387	18	4,400	4,400	72002	.31
	20916	52	2.773	100	8,825	28,240	30916	65	2.387	18	4,400	4,400	72002	.31
	20916	52	2.773	100	8,825	28,240	30916	65	2.387	18	4,400	4,400	72002	.31
	20916	52	2.773	100	8,825	28,240	30916	65	2.387	18	4,400	4,400	72002	.31

TRAPEZOIDAL SCREW ASSEMBLIES

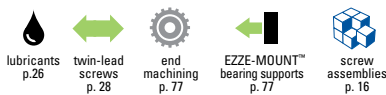

**18mm diameter
20mm diameter**

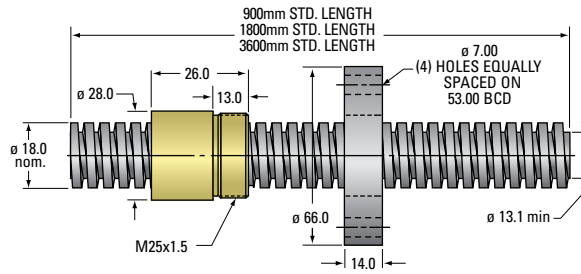

**18mm Trapezoidal Thread
Lead Accuracy $\pm 6.25 \mu\text{m}/25\text{mm}$**

TRAPEZOIDAL SCREW											
Dia x Lead	Part Number		Length (mm)	Material	Pitch (mm)	Starts	Dia (mm)	"A" Dia. (mm)	Thread Code	Wt. (kg/m)	Lash (mm)
	RH	LH									
Tr 18x4	14917	—	900	4140	4	1	18	13.10	917	1.5	0.24
	54917	—	900	SS	4	1	18	13.10	917	1.5	0.24
	15917	—	1800	4140	4	1	18	13.10	917	1.5	0.24
	55917	—	1800	SS	4	1	18	13.10	917	1.5	0.24
Tr 20x4	14903	—	900	4140	4	1	20	14.90	903	2.00	0.24
	54903	—	900	SS	4	1	20	14.90	903	2.00	0.24
	15903	—	1800	4140	4	1	20	14.90	903	2.00	0.24
	55903	—	1800	SS	4	1	20	14.90	903	2.00	0.24
	16903	—	3600	4140	4	1	20	14.90	903	2.00	0.24
	56903	—	3600	SS	4	1	20	14.90	903	2.00	0.24
Tr 20x8	14918	—	900	4140	8	2	20	15.10	918	2.0	0.24
	54918	—	900	SS	8	2	20	15.10	918	2.0	0.24
	15918	—	1800	4140	8	2	20	15.10	918	2.0	0.24
	55918	—	1800	SS	8	2	20	15.10	918	2.0	0.24

POWER • AC™ TRAPEZOIDAL SCREW ASSEMBLIES

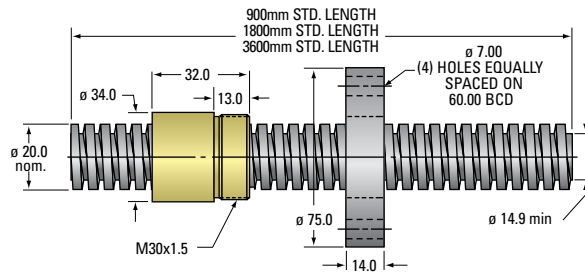

20mm Trapezoidal Thread
Lead Accuracy $\pm 6.25 \mu\text{m}/25\text{mm}$

	BRONZE NUT						PLASTIC NUT						FLANGE	
	Part Number RH	% Efficiency	Torque to Raise 1 kN (N-m)	Wt. (g)	Load capacity (N)		Part Number RH	% Efficiency	Torque to Raise 1 kN (N-m)	Wt. g.	Load capacity (N)		Part Number	Wt. (kg)
					Dynamic	Static					Dynamic	Static		
	20917	30	2.378	155	10,700	34,700	30917	45	1.937	13	5,300	5,300	72002	.31
	20917	30	2.378	155	10,700	34,700	30917	45	1.937	13	5,300	5,300	72002	.31
	20917	30	2.378	155	10,700	34,700	30917	45	1.937	13	5,300	5,300	72002	.31
	20917	30	2.378	155	10,700	34,700	30917	45	1.937	13	5,300	5,300	72002	.31
	20903	35	2.481	173	13,790	44,128	30903	40	2.015	13	6,895	6,895	72003	.39
	20903	35	2.481	173	13,790	44,128	30903	40	2.015	13	6,895	6,895	72003	.39
	20903	35	2.481	173	13,790	44,128	30903	40	2.015	13	6,895	6,895	72003	.39
	20903	35	2.481	173	13,790	44,128	30903	40	2.015	13	6,895	6,895	72003	.39
	20903	35	2.481	173	13,790	44,128	30903	40	2.015	13	6,895	6,895	72003	.39
	20903	35	2.481	173	13,790	44,128	30903	40	2.015	13	6,895	6,895	72003	.39
	20918	49	3.175	173	13,790	44,128	30918	59	2.689	13	6,900	6,900	72004	.54
	20918	49	3.175	173	13,790	44,128	30918	59	2.689	13	6,900	6,900	72004	.54
	20918	49	3.175	173	13,790	44,128	30918	59	2.689	13	6,900	6,900	72004	.54
	20918	49	3.175	173	13,790	44,128	30918	59	2.689	13	6,900	6,900	72004	.54

TRAPEZOIDAL SCREW ASSEMBLIES

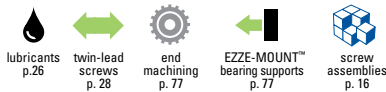

**26mm diameter
40mm diameter**

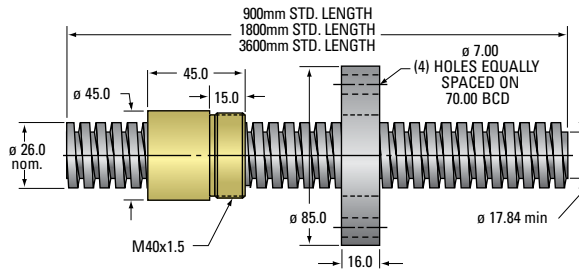

26mm Trapezoidal Thread
Lead Accuracy $\pm 6.25 \mu\text{m}/25\text{mm}$

TRAPEZOIDAL SCREW											
Dia x Lead	Part Number		Length (mm)	Material	Pitch (mm)	Starts	Dia (mm)	"A" Dia. (mm)	Thread Code	Wt. (kg/m)	Lash (mm)
	RH	LH									
Tr 26x6	14904	—	900	4140	6	1	26	17.84	904	3.20	0.30
	54904	—	900	SS	6	1	26	17.84	904	3.20	0.30
	15904	—	1800	4140	6	1	26	17.84	904	3.20	0.30
	55904	—	1800	SS	6	1	26	17.84	904	3.20	0.30
	16904	—	3600	4140	6	1	26	17.84	904	3.20	0.30
	56904	—	3600	SS	6	1	26	17.84	904	3.20	0.30
Tr 40x7	14905	—	900	4140	7	1	40	30.95	905	8.16	0.32
	54905	—	900	SS	7	1	40	30.95	905	8.16	0.32
	15905	—	1800	4140	7	1	40	30.95	905	8.16	0.32
	55905	—	1800	SS	7	1	40	30.95	905	8.16	0.32
	16905	—	3600	4140	7	1	40	30.95	905	8.16	0.32
	56905	—	3600	SS	7	1	40	30.95	905	8.16	0.32

POWER • AC™ TRAPEZOIDAL SCREW ASSEMBLIES

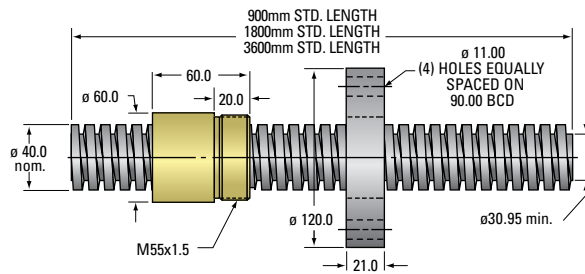

40mm Trapezoidal Thread
Lead Accuracy $\pm 6.25 \mu\text{m}/25\text{mm}$

	BRONZE NUT						PLASTIC NUT						FLANGE	
	Part Number RH	% Efficiency	Torque to Raise 1 kN (N-m)	Wt. (g)	Load capacity (N) Dynamic Static		Part Number RH	% Efficiency	Torque to Raise 1 kN (N-m)	Wt. g.	Load capacity (N) Dynamic Static		Part Number	Wt. (kg)
	20904	39	3.292	440	23,304	74,573	30904	44	2.700	79	11,652	11,652	72004	.54
	20904	39	3.292	440	23,304	74,573	30904	44	2.700	79	11,652	11,652	72004	.54
	20904	39	3.292	440	23,304	74,573	30904	44	2.700	79	11,652	11,652	72004	.54
	20904	39	3.292	440	23,304	74,573	30904	44	2.700	79	11,652	11,652	72004	.54
	20904	39	3.292	440	23,304	74,573	30904	44	2.700	79	11,652	11,652	72004	.54
	20904	39	3.292	440	23,304	74,573	30904	44	2.700	79	11,652	11,652	72004	.54
	20905	.32	4.853	900	55,160	176,512	30905	37	3.909	160	27,580	27,580	72005	1.40
	20905	.32	4.853	900	55,160	176,512	30905	37	3.909	160	27,580	27,580	72005	1.40
	20905	.32	4.853	900	55,160	176,512	30905	37	3.909	160	27,580	27,580	72005	1.40
	20905	.32	4.853	900	55,160	176,512	30905	37	3.909	160	27,580	27,580	72005	1.40
	20905	.32	4.853	900	55,160	176,512	30905	37	3.909	160	27,580	27,580	72005	1.40
	20905	.32	4.853	900	55,160	176,512	30905	37	3.909	160	27,580	27,580	72005	1.40

TRAPEZOIDAL SCREW ASSEMBLIES

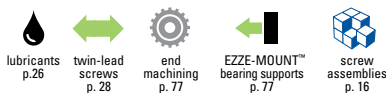

55mm diameter
65mm diameter

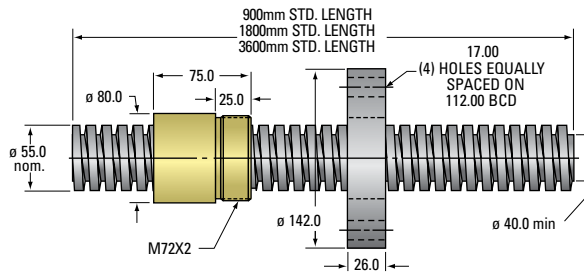

55mm Trapezoidal Thread
Lead Accuracy $\pm 6.25 \mu\text{m}/25\text{mm}$

TRAPEZOIDAL SCREW											
Dia x Lead	Part Number		Length (mm)	Material	Pitch (mm)	Starts	Dia (mm)	"A" Dia. (mm)	Thread Code	Wt. (kg/m)	Lash (mm)
	RH	LH									
Tr 55x12	14906	—	900	4140	12	1	55	40.00	906	14.7	0.42
	15906	—	1800	4140	12	1	55	40.00	906	14.7	0.42
	16906	—	3600	4140	12	1	55	40.00	906	14.7	0.42
Tr 65x12	14907	—	900	4140	12	1	65	50.02	907	21.3	0.42
	15907	—	1800	4140	12	1	65	50.02	907	21.3	0.42
	16907	—	3600	4140	12	1	65	50.02	907	21.3	0.42

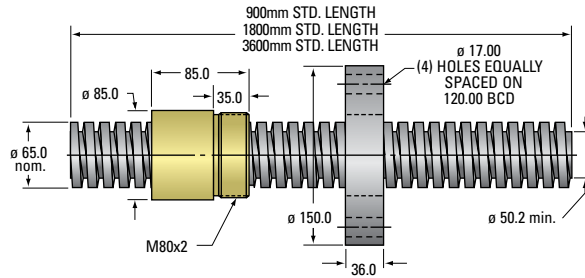

65mm Trapezoidal Thread
Lead Accuracy $\pm 6.25 \mu\text{m}/25\text{mm}$

	BRONZE NUT						PLASTIC NUT						FLANGE	
	Part Number RH	% Efficiency	Torque to Raise 1 kN (N-m)	Wt. (g)	Load capacity (N) Dynamic Static		Part Number RH	% Efficiency	Torque to Raise 1 kN (N-m)	Wt. g.	Load capacity (N) Dynamic Static		Part Number	Wt. (kg)
	20906	37	6.943	1900	104,287	333,718	**	**	**	—	—	—	72006	2.20
	20906	37	6.943	1900	104,287	333,718	**	**	**	—	—	—	72006	2.20
	20906	37	6.943	1900	104,287	333,718	**	**	**	—	—	—	72006	2.20
	20907	33	7.973	2100	145,651	466,084	**	**	**	—	—	—	72007	3.30
	20907	33	7.973	2100	145,651	466,084	**	**	**	—	—	—	72007	3.30
	20907	33	7.973	2100	145,651	466,084	**	**	**	—	—	—	72007	3.30

** Contact our sales engineers.

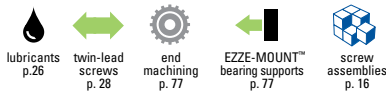



Helix EZZE-MOUNT™ custom end machining and bearing blocks



BEARING MOUNTS AND END MACHINING
PAGES 76-91

Glossary and Technical Data..... 79

Quick Reference Guide.....80-81

Machine Ends: Drawings and Codes 82-84

End Bearing Identification 85

Universal Mount Single and
 Double Bearing Support 86-87

Flange-Mount Single and
 Double Bearing Support 88-89

Universal Mount Bearing Support
 with Motor Mount 90

Flange Mount Bearing Support
 with Motor Mount 91

BEARING MOUNTS
END MACHINING

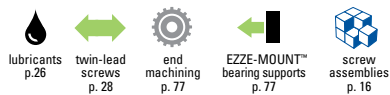

EZZE-MOUNT™ AND END MACHINING

INTRODUCTION

Linear motion applications utilizing a ball screw or an Acme screw require this screw end machining matched with precision bearing mounts. Helix, Inc. offers both the bearing mounts and end machining as a complete assembly.

Helix can provide the following end machining services:

- Screws cut to precision lengths
- Annealing
- Straightening
- CNC turning and milling
- Grinding
- Assembly of bearing mounts
- Inspection
- Specialized material handling and packaging

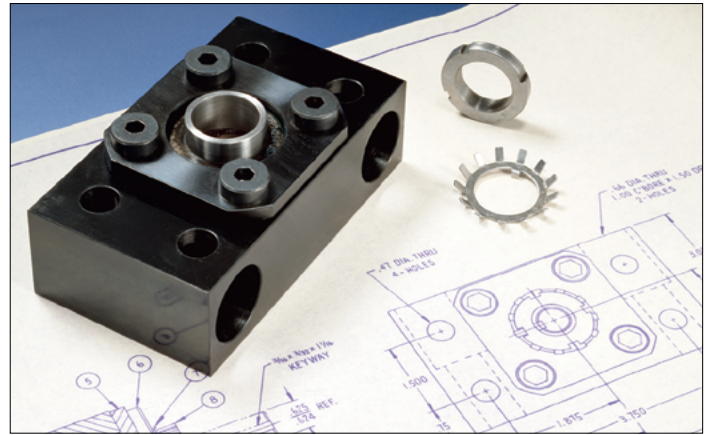

GLOSSARY AND DEFINITIONS

EZZE-MOUNT

EZZE-MOUNT bearing blocks contain precision anti-friction bearings and are designed to be used with both ball screws and Acme screws. Single and double bearing base mount and flange mount versions of EZZE-MOUNT bearing blocks are available.

STANDARD ENDS

For each screw size, Helix has designed a family of standard machined ends applicable to a variety of bearing arrangements. The use of standard machined end designs offers quick deliveries. See page 82-84 for details.

LAND DIAMETER

The land diameter is the outside diameter of the screw. The difference between the land diameter and the bearing journal is the resulting bearing shoulder.

ROOT DIAMETER

The diameter of the screw measured at the bottom of the thread. This diameter is used for determining journal sizes. If the bearing journal diameter is larger than the root diameter, thread tracings may be visible. Generally, these tracings do not have an effect on bearing performance.

JOURNAL

A smooth diameter machined on the end of screw used as a mounting surface for bearings, couplings, pulleys, gears, etc.

STRAIGHTNESS

Although Helix PowerAc screws are manufactured from straight, cylindrical material, internal stresses may cause the material to bend. When ordering random lengths or cut material without end machining, straightening is recommended. Handling or machining of screws can also cause the material to bend. Before, during and after machining, additional straightening is required.

END FIXITY

End fixity refers to the method by which the ends of the screw are supported. The degree of end fixity is related to the amount of restraint of the ends of the screw.

The three basic types of end fixity are:

- | | |
|---------------|---|
| Free | No support |
| Simple | Shaft restrained against radial and/or axial loads |
| Fixed | Shaft rigidly restrained against radial, axial and moment loads |

See pages 8 and 9 for a more detailed definition of end fixity.

LOCKNUT THREADS

Locknut threads are machined to allow the bearing retention on the screw shaft by means of a locknut. The thread used on standard machined ends follows American National Form NS Class 3. Precision ground locknuts are available from Helix on special order.

UNDERCUTS AND RADII

Whenever a shaft changes diameter, an undercut or a radius is machined into the transition to minimize stress concentration. Undercuts are preferred for bearing shoulders because they allow clearance for the corner of the bearing. (See FIG. 1)

FIG. 1

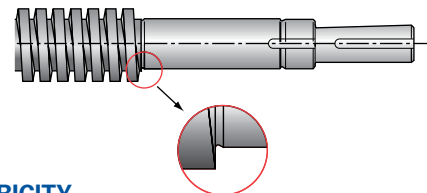

CONCENTRICITY

Concentricity refers to multiple diameters sharing the same center. For end machining, close concentricity allows all components to rotate around the same axis resulting in smooth operation and long operating life.

EZZE-MOUNT™ SCREW SUPPORTS/END MACHINING

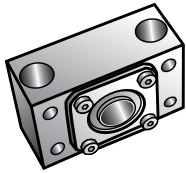

Universal Mount
Double Bearing

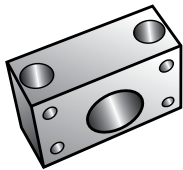

Universal Mount
Single Bearing

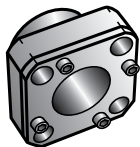

Flange Mount
Double Bearing

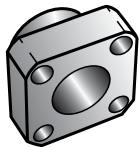

Flange Mount
Single Bearing

NOMINAL DIA-LEAD	END CODE TYPE		EZZE-MOUNT			
			UNIVERSAL MOUNTS		FLANGE MOUNTS	
	1,2,3	4	Double	Single	Double	Single
1/4 - 3	3	2	—	—	—	—
1/4 - 4	3	2	—	—	—	—
1/4 - 20	3	2	—	—	—	—
5/16 - 2	5	2	—	—	—	—
5/16 - 4	5	2	—	—	—	—
3/8 - 1	6	4*	—	—	—	—
3/8 - 2	7	4	EZM-1007	EZM-4007	EZF-1007	EZF-4007
3/8 - 4	7	4	EZM-1007	EZM-4007	EZF-1007	EZF-4007
3/8 - 5	7*	4	EZM-1007	EZM-4007	EZF-1007	EZF-4007
3/8 - 6	7*	4	EZM-1007	EZM-4007	EZF-1007	EZF-4007
3/8 - 8	7	4	EZM-1007	EZM-4007	EZF-1007	EZF-4007
3/8 - 10	7	4	EZM-1007	EZM-4007	EZF-1007	EZF-4007
3/8 - 12	7*	4	EZM-1007	EZM-4007	EZF-1007	EZF-4007
3/8 - 16	7	4	EZM-1007	EZM-4007	EZF-1007	EZF-4007
1/2 - 1	9	6	EZM-1009	EZM-4009	EZF-1009	EZF-4009
1/2 - 2	10	6	EZM-3010	EZM-4010	EZF-3010	EZF-4010
1/2 - 4	8	4	EZM-1008	EZM-4008	EZF-1008	EZF-4008
1/2 - 5	9	6	EZM-1009	EZM-4009	EZF-1009	EZF-4009
1/2 - 10	9	6*	EZM-1009	EZM-4009	EZF-1009	EZF-4009
5/8 - 2 2/3	10	6	EZM-3010	EZM-4010	EZF-3010	EZF-4010
5/8 - 5	9	6	EZM-1009	EZM-4009	EZF-1009	EZF-4009
5/8 - 5(2)	12	6	EZM-3012	EZM-4012	EZF-3012	EZF-4012
5/8 - 8	10	6	EZM-3010	EZM-4010	EZF-3010	EZF-4010
5/8 - 10	12	8	EZM-3012	EZM-4012	EZF-3012	EZF-4012
3/4 - 2	12	8	EZM-3012	EZM-4012	EZF-3012	EZF-4012
3/4 - 3	12	8	EZM-3012	EZM-4012	EZF-3012	EZF-4012
3/4 - 5	12	8	EZM-3012	EZM-4012	EZF-3012	EZF-4012
3/4 - 6	12	8	EZM-3012	EZM-4012	EZF-3012	EZF-4012
3/4 - 10	15	8	EZM-3015	EZM-4015	EZF-3015	EZF-4015
7/8 - 6	15	10	EZM-3015	EZM-4015	EZF-3015	EZF-4015
1 - 1	20	12	EZM-2020	EZM-4020	EZF-2020	EZF-4020
1 - 2	17	10	EZM-3017	EZM-4017	EZF-3017	EZF-4017
1 - 4	17	10	EZM-3017	EZM-4017	EZF-3017	EZF-4017
1 - 5	17	10	EZM-3017	EZM-4017	EZF-3017	EZF-4017
1 - 6	17	10	EZM-3017	EZM-4017	EZF-3017	EZF-4017
1 - 10	20	12	EZM-2020	EZM-4020	EZF-2020	EZF-4020
1 1/8 - 5	20	12	EZM-2020	EZM-4020	EZF-2020	EZF-4020
1 1/4 - 4	20	12	EZM-2020	EZM-4020	EZF-2020	EZF-4020

EZZE-MOUNTS™ / END MACHINING

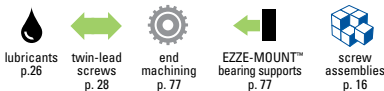

* Some journals may show tracings of the thread

QUICK REFERENCE: MACHINED ENDS BEARING SUPPORTS - ACME SCREWS

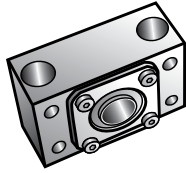

Universal Mount
Double Bearing

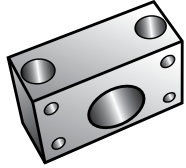

Universal Mount
Single Bearing

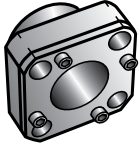

Flange Mount
Double Bearing

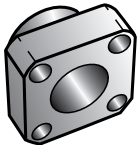

Flange Mount
Single Bearing

NOMINAL DIA-LEAD	EZZE-MOUNT					
	END CODE TYPE		UNIVERSAL MOUNTS		FLANGE MOUNTS	
	1,2,3	4	Double	Single	Double	Single
1¼ - 5	25	16	EZM-3025	EZM-4025	EZF-3025	EZF-4025
1½ - 2	30	19	EZM-2030	EZM-4030	EZF-2030	EZF-4030
1½ - 2½	25	16	EZM-3025	EZM-4025	EZF-3025	EZF-4025
1½ - 4	30	19	EZM-2030	EZM-4030	EZF-2030	EZF-4030
1½ - 5	30	19	EZM-2030	EZM-4030	EZF-2030	EZF-4030
1½ - 10	30	19	EZM-2030	EZM-4030	EZF-2030	EZF-4030
1¾ - 4	35	19	EZM-2035	EZM-4035	EZF-2035	EZF-4035
2 - 2	35	19	EZM-2035	EZM-4035	EZF-2035	EZF-4035
2 - 4	40	22	EZM-2040	EZM-4040	EZF-2040	EZF-4040
2 - 5	40	28	EZM-2040	EZM-4040	EZF-2040	EZF-4040
2¼ - 2	40	24	EZM-3040	EZM-4040	EZF-3040	EZF-4040
2¼ - 4	45	28	EZM-3045	EZM-4045	EZF-3045	EZF-4045
2½ - 2	45	28	EZM-3045	EZM-4045	EZF-3045	EZF-4045
2½ - 3	50	32	EZM-3050	EZM-4050	EZF-3050	EZF-4050
2½ - 4	50	32	EZM-3050	EZM-4050	EZF-3050	EZF-4050
3 - 2	60	39	EZM-3060	EZM-4060	—	—
3¾ - 1½	65	39*	EZM-3065	EZM-4065	—	—
3¾ - 1½	75	48	—	—	—	—
4½ - 1½	95	55	—	—	—	—
5 - 1½	105	67	—	—	—	—
6 - 1½	—	—	—	—	—	—

* Some journals may show tracings of the thread

See PowerAc™ pages 34-59 for screw dimensions. Note: When selecting the bearing support for an application with high axial loads, the capacities of the bearings and locknuts must be considered.

QUICK REFERENCE: MACHINED ENDS - BEARING SUPPORTS - TRAPEZOIDAL SCREWS

NOMINAL DIA-LEAD	END CODE TYPE		EZZE-MOUNT			
			UNIVERSAL MOUNTS		FLANGE MOUNTS	
			Double	Single	Double	Single
Tr 8 x 1.5	6	4	EZM-1006	EZM-4006	EZF-1006	EZF-4006
Tr 8 x 4	6	4	EZM-1006	EZM-4006	EZF-1006	EZF-4006
Tr 8 x 8	6	4	EZM-1006	EZM-4006	EZF-1006	EZF-4006
Tr 10 x 2	7	4	EZM-1007	EZM-4007	EZF-1007	EZF-4007
Tr 10x3 (1.5)	7	4	EZM-1007	EZM-4007	EZF-1007	EZF-4007
Tr 10 x 9	7	4	EZM-1007	EZM-4007	EZF-1007	EZF-4007
Tr 11 x 6	7	4	EZM-1007	EZM-4007	EZF-1007	EZF-4007
Tr 12x3	7	4	EZM-1007	EZM-4007	EZF-1007	EZF-4007
Tr 12 x 6	7	4	EZM-1007	EZM-4007	EZF-1007	EZF-4007
Tr 12 x 10	7	4	EZM-1007	EZM-4007	EZF-1007	EZF-4007
Tr 14 x 3	7	6	EZM-1007	EZM-4007	EZF-1007	EZF-4007
Tr 14 x 4	7	6	EZM-1007	EZM-4007	EZF-1007	EZF-4007
Tr 16 x 2	10	6	EZM-3010	EZM-4010	EZF-3010	EZF-4010
Tr 16x4	10	6	EZM-3010	EZM-4010	EZF-3010	EZF-4010
Tr 16 x 6	10	6	EZM-3010	EZM-4010	EZF-3010	EZF-4010
Tr 16 x 8	10	6	EZM-3010	EZM-4010	EZF-3010	EZF-4010
Tr 18 x 4	10	6	EZM-3010	EZM-4010	EZF-3010	EZF-4010
Tr 20x4	12	8	EZM-3012	EZM-4012	EZF-3012	EZF-4012
Tr 20 x 8	12	8	EZM-3012	EZM-4012	EZF-3012	EZF-4012
Tr 26x6	17	10	EZM-3017	EZM-4017	EZF-3017	EZF-4017
Tr 40x7	30	19	EZM-2030	EZM-4030	EZF-2030	EZF-4030
Tr 55x12	30	19	EZM-2030	EZM-4030	EZF-2030	EZF-4030
Tr 65x12	45	28	EZM-3045	EZM-4045	EZF-3045	EZF-4045

* Some journals may show tracings of the thread

See PowerAc pages 64-69 for screw dimensions. Note: When selecting the bearing support for an application with high axial loads, the capacities of the bearings and locknuts must be considered.

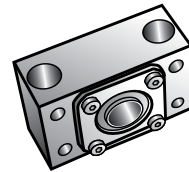

Universal Mount
Double Bearing

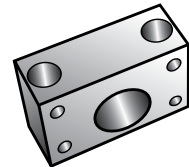

Universal Mount
Single Bearing

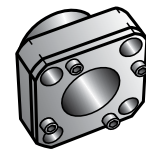

Flange Mount
Double Bearing

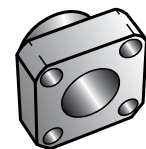

Flange Mount
Single Bearing

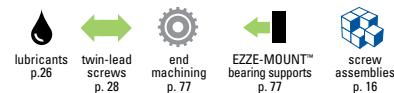

MACHINED ENDS DRAWINGS AND CODES

Specifying standard machined ends results in quicker deliveries. The machined ends shown below represent designs that are compatible with common application requirements for either simple or fixed bearing support. Included in the chart are the

locknut and lockwasher identification. These standard ends may be machined and ground to finish size. NOTE: A Type 1N end is required for single bearing EZZE-MOUNT™. A Type 3 K, L, or N end is required for double bearing EZZE-MOUNT.

Type 1K (with keyway)
Type 1L (without keyway)

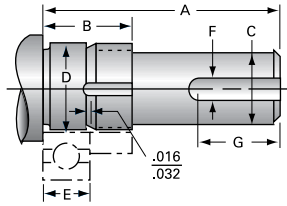

Type 2K (with keyway)
Type 2L (without keyway)

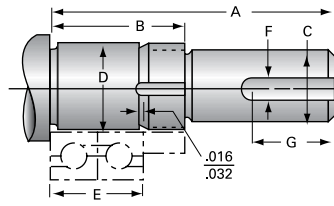

Type 3K (with keyway)
Type 3L (without keyway)

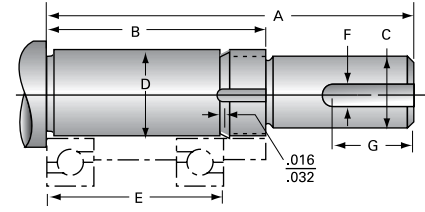

Machine End Code	TYPE 1 (K, L, N) Typical Journal for Single Bearing			TYPE 2 (K, L, N) Typical Journal for Duplexed Bearing			TYPE 3 (K, L, N) Typical Journal for Multiple Sets of Duplexed Bearing			COMMON DIMENSIONS FOR TYPE 1, 2, 3 (K, L, N)				Lock nut	Lock washer
	A	B	E	A	B	E	A	B	E	C	D	F	G		
2	0.52	0.32	0.095	0.65	0.45	0.220	0.99	0.79	0.560	.059/.058	.0986/.0983	N/A	N/A	M2.5	N/A
3	0.56	0.33	0.095	0.69	0.46	0.220	1.03	0.80	0.560	.079/.092	.1183/.1180	N/A	N/A	M3	N/A
4	0.69	0.43	0.177	0.91	0.65	0.394	1.38	1.12	0.860	.098/.097	.1577/.1574	N/A	N/A	#6-32	N/A
5	0.88	0.55	0.236	1.09	0.78	0.472	1.56	1.26	0.944	.125/.124	.1970/.1967	N/A	N/A	#10-32	N/A
6	0.88	0.55	0.236	1.09	0.78	0.472	1.56	1.26	0.944	.125/.124	.2363/.2360	N/A	N/A	#10-32	N/A
7	1.12	0.65	0.276	1.41	0.93	0.552	1.94	1.48	1.104	.187/.186	.2757/.2754	0.063	0.34	¼-20	N/A
8	1.31	0.68	0.276	1.56	0.96	0.552	2	1.44	1.06	.250/.249	.3151/.3148	0.094	0.46	⅜-24	N/A
9	1.38	0.72	0.315	1.69	1.04	0.63	2.38	1.81	1.438	.250/.249	.3544/.3541	0.094	0.46	⅜-24	N/A
10	1.37	0.69	0.315	1.67	1	0.63	2.5	1.81	1.438	.312/.311	.3939/.3936	0.125	0.5	N-00	W-00
12	2.11	0.81	0.394	2.5	1.2	0.788	3.29	1.99	1.576	.406/.405	.4726/.4723	0.125	1	N-01	W-01
15	2.15	0.84	0.433	2.59	1.27	0.866	3.5	2.18	1.732	.500/.499	.5908/.5905	0.125	1	N-02	W-02
17	2.23	0.92	0.472	2.71	1.39	0.944	3.65	2.33	1.888	.500/.499	.6695/.6692	0.125	1	N-03	W-03
20	2.37	1.06	0.551	2.93	1.61	1.102	4.03	2.71	2.204	.625/.624	.7877/.7873	0.188	1	N-04	W-04
25	2.68	1.12	0.591	3.27	1.71	1.182	4.45	2.89	2.364	.750/.749	.9846/.9842	0.188	1	N-05	W-05
30	2.97	1.16	0.63	3.6	1.79	1.26	4.86	3.05	2.52	1.000/.999	1.1814/1.1810	0.25	1.25	N-06	W-06
35	3.33	1.23	0.669	4	1.9	1.338	5.34	3.24	2.676	1.250/1.249	1.3784/1.3779	0.25	1.63	N-07	W-07
40	3.65	1.46	0.906	4.55	2.37	1.812	6.37	4.18	3.624	1.375/1.374	1.5752/1.5747	0.313	1.5	N-08	W-08
45	3.73	1.54	0.984	4.71	2.52	1.968	6.68	4.49	3.936	1.375/1.374	1.7721/1.7716	0.313	1.5	N-09	W-09
50	4.56	1.68	1.063	5.62	2.75	2.126	7.75	4.87	4.252	1.750/1.749	1.9689/1.9684	0.375	2.3	N-10	W-10
60	5.56	1.88	1.221	6.78	3.1	2.442	9.22	5.54	4.884	2.250/2.249	2.3627/2.3621	0.5	2.75	N-12	W-12
65	6.71	1.96	1.299	7.99	3.24	2.598	10.59	5.84	5.197	2.375/2.374	2.5591/2.5585	0.625	3.7	N-13	W-13
75	7.68	2.18	1.457	9.14	3.64	2.914	11.33	6.56	5.828	2.750/2.749	2.9533/2.9527	0.625	3.7	AN-15	W-15
80	6.95	2.26	1.535	8.49	3.8	3.07	11.56	6.87	6.14	3.000/2.998	3.1501/3.1495	0.75	3.9	AN-16	W-16
95	9.6	2.6	1.772	11.37	4.37	3.544	14.92	7.92	7.088	3.500/3.499	3.7402/3.7394	0.875	6	AN-19	W-19
105	10.84	2.84	1.929	12.76	4.76	3.858	16.62	8.62	7.716	4.000/3.999	4.1345/4.1338	1	6.75	AN-21	W-21

Type 1N

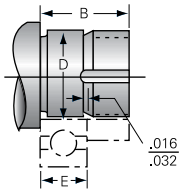

Type 2N

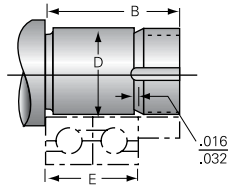

Type 3N

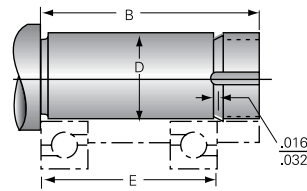

END TYPES

- 1K, 2K, 3K and 4K are designed with a shaft extension and keyway for square keys.
- 1L, 2L, 3L and 4L are designed with a shaft extension without a keyway.
- 1N, 2N, 3N and 4N are designed to be a non-driven support end.
- Double bearing supports use a Type 3N, 3L and 3K.
- Single bearing supports use Type 1N.

Where standard ends do not satisfy the application requirements, special ends may be machined to customer specifications. Please submit a print for a prompt and competitive quotation.

PRECISION LOCKNUTS

Helix offers precision ground locknuts for extreme applications requiring ground face and precision ground thread with extra thread engagement. These locknuts have radial thread set screws to ensure secure positioning. Please request a catalog.



lubricants p.26
twin-lead screws p.28
end machining p.77
EZZE-MOUNT™ bearing supports p.77
screw assemblies p.16

Examples of custom end machining

MACHINED ENDS DRAWINGS AND CODES *(continued)*

Type 4K (with keyway)
Type 4L (without keyway)

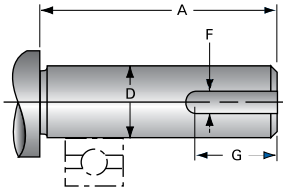

Type 4N

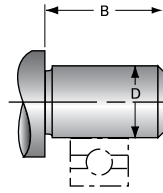

TYPE 4 (K, L, N) Typical Journal for Pillow Block

Machine End Code	A	B	D	F	G
1	.50	.20	.0986 / .0983	N/A	N/A
2	.75	.25	.1251 / .1248	N/A	N/A
3	1.13	.38	.1877 / .1874	N/A	N/A
4	1.38	.50	.2501 / .2498	.063	.63
6	1.50	.75	.3751 / .3748	.125	.75
8	2.63	1.00	.5000 / .4995	.125	1.50
10	2.63	1.25	.6250 / .6245	.188	1.50
12	2.72	1.50	.7500 / .7495	.188	1.50
16	2.84	1.50	1.0000 / .9995	.250	1.50
19	3.25	1.78	1.1875 / 1.1870	.250	1.75
22	4.44	2.06	1.3750 / 1.3745	.313	1.87
24	4.56	2.25	1.5000 / 1.4995	.313	3.00
28	4.94	2.63	1.7500 / 1.7495	.375	3.00
32	5.19	3.50	2.0000 / 1.9995	.500	3.00
39	7.25	3.66	2.4375 / 2.4365	.625	4.69
42	7.75	3.94	2.6250 / 2.6240	.625	4.75
48	8.25	4.50	3.0000 / 2.9990	.750	4.88
55	8.50	5.16	3.4375 / 3.4365	.875	5.00
60	9.38	5.63	3.7500 / 3.7490	1.000	5.38
67	12.13	6.28	4.1875 / 4.1865	1.000	7.00

Type 5K (with keyway)
Type 5L (without keyway)

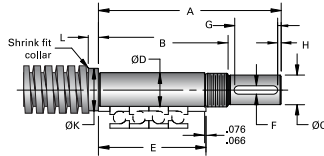

Type 5N

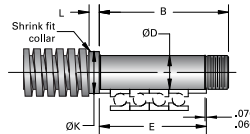

Machine End Code	TYPE 5 (K, L) Typical Journal for EZRF Bearing Block (in)					COMMON DIMENSIONS FOR TYPE 5 (K L N) (in)					
	A	C	F	G	H	B	D	E	K	L	LOCK NUT
12	4.61	.394/.393	0.118	1.02	0.08	3.35	.4728/.4723	2.717	0.71	0.31	SFZ 12 × 1
15	5.24	.472/.471	0.157	1.30	0.12	3.66	.5909/.5904	2.913	0.87	0.35	SFZ 15 × 1
17	5.55	.591/.590	0.197	1.30	0.12	3.98	.6696/.6692	3.150	0.94	0.35	SFZ 17 × 1
20	5.94	.669/.668	0.197	1.46	0.16	4.13	.7878/.7872	3.307	1.10	0.35	SFZ 20 × 1
25	6.69	.787/.786	0.236	1.61	0.20	4.69	.9846/.9841	3.740	1.26	0.39	SFZ 25 × 1.5
35	8.07	1.181/1.180	0.315	2.01	0.16	5.63	1.3784/1.3778	4.606	1.77	0.39	SFZ 35 × 1.5
40	8.50	1.378/1.377	0.394	2.01	0.16	6.02	1.5752/1.5746	5.000	1.97	0.47	SFZ 40 × 1.5
45	8.98	1.575/1.574	0.472	2.01	0.20	6.42	1.7721/1.7715	5.394	2.17	0.47	SFZ 45 × 1.5
55	10.43	1.969/1.968	0.551	2.52	0.24	7.24	2.1658/2.1651	6.063	2.56	0.55	SFZ 55 × 2
60	11.46	2.165/2.164	0.630	2.80	0.24	7.94	2.3627/2.3619	6.732	2.95	0.63	SFZ 60 × 2
70	13.15	2.362/2.361	0.709	3.58	0.28	8.74	2.7564/2.7556	7.402	3.35	0.71	SFZ 70 × 2
75	13.62	2.559/2.558	0.709	3.58	0.31	9.13	2.9532/2.9525	7.795	3.54	0.71	SFZ 75 × 2

EZZE-MOUNT™ END BEARING IDENTIFICATION

EZM SINGLE BEARING

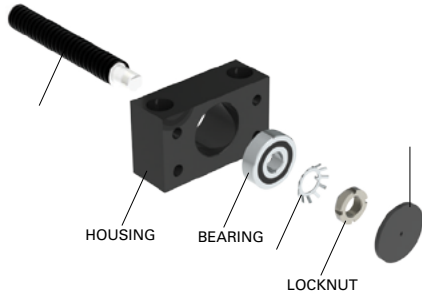

EZM DOUBLE BEARING

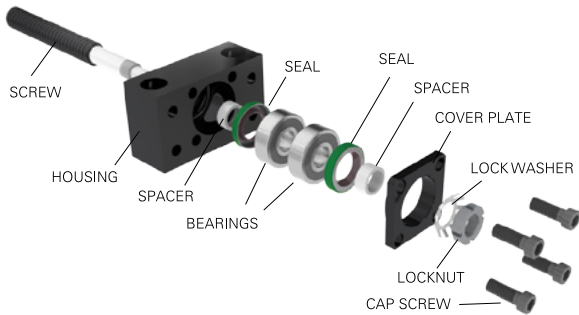

EZRF

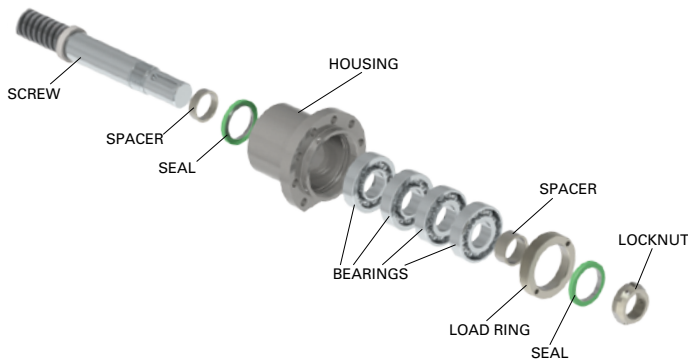

EZM Part#	Bearing	Locknut No.	Locknuts Max Axial
			Load Lb
EZM-1007* EZF-1007*	627-2RS1	¼" -20	1800
EZM-1008* EZF-1008*	608-2RS1	⅝" -24	2300
EZM-1009* EZF-1009*	609-2RS1	⅝" -24	2300
EZM-3010* EZF-3010*	6000-2RS1	N-00	4100
EZM-3012 EZF-3012	7301	N-01	6900
EZM-3015 EZF-3015	7302	N-02	8100
EZM-3017 EZF-3017	7303	N-03	9900
EZM-2020 EZF-2020	7204	N-04	13200
EZM-3025 EZF-3025	7305	N-05	16200
EZM-2030 EZF-2030	7206	N-06	23700
EZM-3045	7309	N-09	26500
EZM-3060	7312	N-12	37000
EZM-3080	7316	AN-16	53700

*Use (2) deep groove ball bearings, all others - use (2) angular

EZRF Part#	Bearing	Locknut No.	Locknuts Max Axial
			Load kN
EZRF-3012	7301	SFZ 12×1	40
EZRF-3015	7302	SFZ 15×1	60
EZRF-3017	7303	SFZ 17×1	80
EZRF-3020	7304	SFZ 20×1	90
EZRF-3025	7305	SFZ 25×1.5	130
EZRF-3035	7307	SFZ 35×1.5	190
EZRF-3040	7308	SFZ 40×1.5	210
EZRF-3045	7309	SFZ 45×1.5	240
EZRF-3055	7311	SFZ 55×2	340
EZRF-3060	7312	SFZ 60×2	380
EZRF-3070	7314	SFZ 70×2	490
EZRF-3075	7315	SFZ 75×2	520



EZZE-MOUNT™ UNIVERSAL MOUNT SINGLE AND DOUBLE BEARING SUPPORT

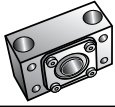

UNIVERSAL-MOUNT DOUBLE

Double Angular Contact Bearing, which should be used with Type 3 Standard Ends

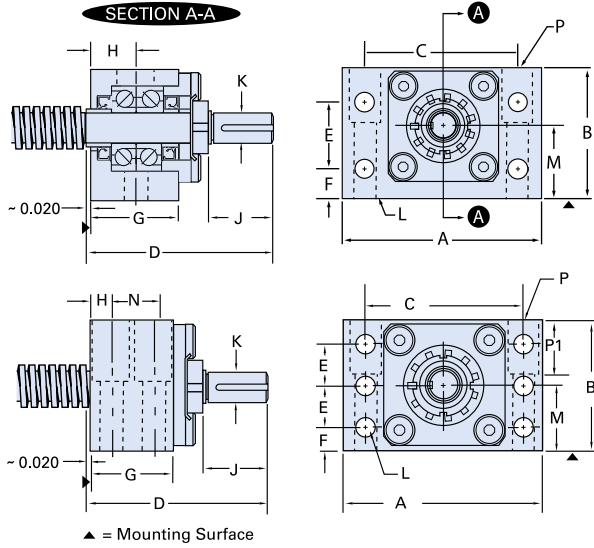

Double Part No.	A	B	C	D	E
EZM-1007	2.00	1.38	1.50	1.94	0.88
EZM-1008	2.00	1.38	1.50	2.00	0.88
EZM-1009	2.75	2.00	2.00	2.38	1.38
EZM-3010	2.75	2.00	2.00	2.50	1.38
EZM-3012	3.50	2.22	2.75	3.29	1.25
EZM-3015	3.50	2.52	2.75	3.50	1.25
EZM-3017	4.50	2.69	3.38	3.65	1.38
EZM-2020	5.00	3.03	3.75	4.03	1.50
EZM-3025	6.50	3.69	4.75	4.45	2.00
EZM-2030	6.50	3.69	4.75	4.86	2.00
EZM-3045	8.50	5.62	6.62	6.68	1.81
EZM-3060	10.00	7.50	8.00	9.22	2.50
EZM-3080	12.50	8.50	10.00	11.56	2.75

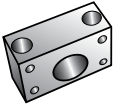

UNIVERSAL-MOUNT SINGLE

Single Radial Bearing, which should be used with Type 1 Standard Ends

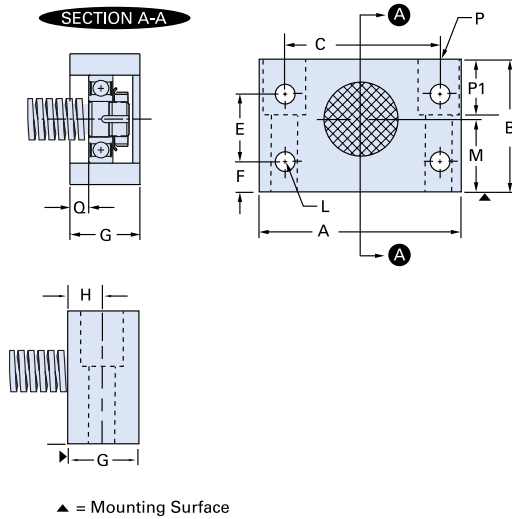

Single Part No.	A	B	C	D	E
EZM-4007	2.00	1.38	1.50	—	0.88
EZM-4008	2.00	1.38	1.50	—	0.88
EZM-4009	2.75	2.00	2.00	—	1.38
EZM-4010	2.75	2.00	2.00	—	1.38
EZM-4012	3.50	2.22	2.75	—	1.25
EZM-4015	3.50	2.52	2.75	—	1.25
EZM-4017	4.50	2.69	3.38	—	1.38
EZM-4020	5.00	3.03	3.75	—	1.50
EZM-4025	6.50	3.69	4.75	—	2.00
EZM-4030	6.50	3.69	4.75	—	2.00
EZM-4045	8.50	5.62	6.62	—	1.81
EZM-4060	10.00	7.50	8.00	—	2.50

EZZE-MOUNT™ SCREW SUPPORTS/END MACHINING

F	G	H	J	K Shaft Dia.		L Thru (4 or 6)	M	N	P			Q	End Code	
									Bolt Size (2 or 4)	Thru	C'Bore			P1
0.25	1.06	0.50	0.46	0.187	0.186	0.22(4)	0.687	—	¼ × 1⅝(2)	0.28	0.41	0.41	—	7
0.25	1.06	0.50	0.56	0.250	0.249	0.22(4)	0.687	—	¼ × 1⅝(2)	0.28	0.41	0.41	—	8
0.31	1.19	0.56	0.56	0.250	0.249	0.28(4)	1.000	—	⅝ × 2(2)	0.34	0.50	0.56	—	9
0.31	1.19	0.56	0.69	0.312	0.311	0.28(4)	1.000	—	⅝ × 2(2)	0.34	0.50	0.56	—	10
0.50	1.38	0.69	1.30	0.406	0.405	0.28(4)	1.187	—	⅜ × 1¾(2)	0.41	0.62	1.00	—	12
0.80	1.38	0.69	1.30	0.500	0.499	0.28(4)	1.438	—	⅜ × 2⅝(2)	0.41	0.62	1.00	—	15
0.62	1.69	0.84	1.30	0.500	0.499	0.41(4)	1.500	—	½ × 2¼(2)	0.53	0.88	1.25	—	17
0.75	1.72	0.86	1.30	0.625	0.624	0.47(4)	1.625	—	⅝ × 2½(2)	0.66	1.00	1.50	—	20
0.88	1.94	0.97	1.61	0.750	0.749	0.66(4)	1.875	—	⅞ × 3¼(2)	0.91	1.38	1.75	—	25
0.88	1.94	0.97	1.81	1.000	0.999	0.66(4)	1.875	—	⅞ × 3¼(2)	0.91	1.38	1.75	—	30
1.00	3.47	0.88	2.19	1.375	1.374	0.81(6)	2.812	1.71	1 × 5(4)	1.03	1.56	2.13	—	45
1.50	4.19	1.03	3.68	2.250	2.249	1.03(6)	4.000	2.13	1 × 5(4)	1.03	1.56	4.00	—	60
1.75	5.13	1.219	4.69	3.000	2.998	1.28(6)	4.500	2.68	1¼ × 4¾(4)	1.28	1.94	4.75	—	80

NOTE: When selecting the bearing support for an application with high axial loads, the capacities of the bearings and locknuts must be considered.

F	G	H	J	K Shaft Dia.		L Thru (4 or 6)	M	N	P			Q	End Code	
									Bolt Size (2 or 4)	Thru	C'Bore			P1
0.25	1.06	0.50	—	—	—	0.22(4)	0.687	—	¼ × 1⅝(2)	0.28	0.41	0.41	0.19	7
0.25	1.06	0.50	—	—	—	0.22(4)	0.687	—	¼ × 1⅝(2)	0.28	0.41	0.41	0.19	8
0.31	1.19	0.56	—	—	—	0.28(4)	1.000	—	⅝ × 2(2)	0.34	0.50	0.56	0.38	9
0.31	1.19	0.56	—	—	—	0.28(4)	1.000	—	⅝ × 2(2)	0.34	0.50	0.56	0.38	10
0.50	1.38	0.69	—	—	—	0.28(4)	1.187	—	⅜ × 1¾(2)	0.41	0.62	1.00	0.33	12
0.80	1.38	0.69	—	—	—	0.28(4)	1.438	—	⅜ × 2⅝(2)	0.41	0.62	1.00	0.33	15
0.62	1.69	0.84	—	—	—	0.41(4)	1.500	—	½ × 2¼(2)	0.53	0.88	1.25	0.38	17
0.75	1.72	0.86	—	—	—	0.47(4)	1.625	—	⅝ × 2½(2)	0.66	1.00	1.50	0.5	20
0.88	1.94	0.97	—	—	—	0.66(4)	1.875	—	⅞ × 3¼(2)	0.91	1.38	1.75	0.52	25
0.88	1.94	0.97	—	—	—	0.66(4)	1.875	—	⅞ × 3¼(2)	0.91	1.38	1.75	0.52	30
1.00	3.47	0.88	—	—	—	0.81(6)	2.812	1.71	1 × 5(4)	1.03	1.56	2.13	0.98	45
1.50	4.19	1.03	—	—	—	1.03(6)	4.000	2.13	1 × 5(4)	1.03	1.56	4.00	1.22	60

lubricants p. 28
twin-lead screws p. 28
end machining p. 77
EZZE-MOUNT™ bearing supports p. 77
screw assemblies p. 16

EZSE-MOUNT™ FLANGE-MOUNT SINGLE AND DOUBLE BEARING SUPPORT



FLANGE-MOUNT DOUBLE

Double Angular Contact Bearing, which should be used with Type 3 Standard Ends

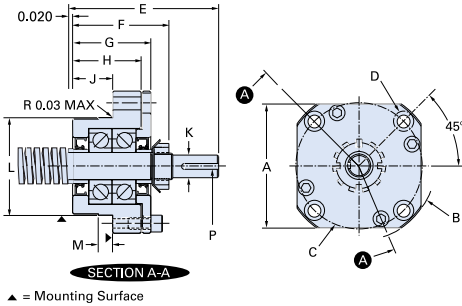

Double Part No.	A	B	C	D Thru	C'bore
EZF-1007	1.88	2.44	1.875	0.266	0.44
EZF-1008	1.88	2.44	1.875	0.266	0.44
EZF-1009	2.00	2.60	2.000	0.266	0.44
EZF-3010	2.00	2.60	2.000	0.266	0.44
EZF-3012	2.50	3.17	2.500	0.266	0.44
EZF-3015	2.70	3.27	2.750	0.281	0.44
EZF-3017	3.38	4.03	3.250	0.344	0.53
EZF-2020	3.38	4.03	3.250	0.344	0.53
EZF-3025	4.38	5.31	4.250	0.531	0.81
EZF-2030	4.38	5.31	4.250	0.531	0.81
EZF-3045	6.50	7.88	6.313	0.781	1.25



FLANGE-MOUNT SINGLE

Single Radial Bearing, which should be used with Type 1 Standard Ends

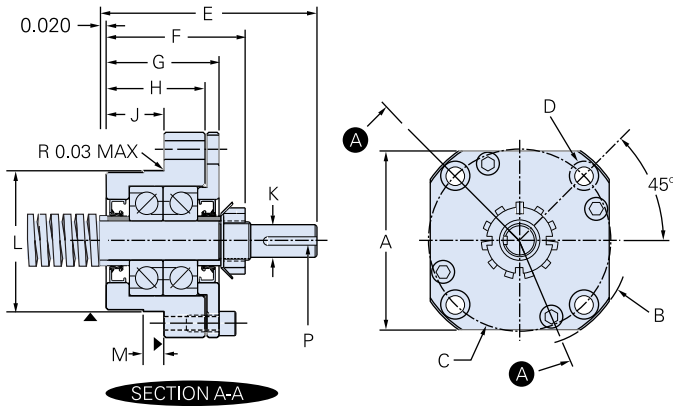

Single Part No.	A	B	C	D Thru	C'bore
EZF-4007	1.88	2.44	1.875	0.266	0.44
EZF-4008	1.88	2.44	1.875	0.266	0.44
EZF-4009	2.00	2.60	2.000	0.266	0.44
EZF-4010	2.00	2.60	2.000	0.266	0.44
EZF-4012	2.50	3.17	2.500	0.266	0.44
EZF-4015	2.70	3.27	2.750	0.281	0.44
EZF-4017	3.38	4.03	3.250	0.344	0.53
EZF-4020	3.38	4.03	3.250	0.344	0.53
EZF-4025	4.38	5.31	4.250	0.531	0.81
EZF-4030	4.38	5.31	4.250	0.531	0.81
EZF-4045	6.50	7.88	6.313	0.781	1.25

E	F	G	H	J	K Shaft Dia.	L	M	P	Q	END CODE
1.94	1.44	1.06	0.82	0.50	0.187-0.186	1.3775-1.3770	0.188	0.063	—	7
2.00	1.44	1.06	0.82	0.50	0.250-0.249	1.3775-1.3770	0.188	0.094	—	8
2.38	1.81	1.33	1.09	0.71	0.250-0.249	1.4957-1.4951	0.188	0.094	—	9
2.50	1.81	1.33	1.09	0.71	0.312-0.311	1.4957-1.4951	0.190	0.125	—	10
3.29	1.99	1.57	1.38	0.75	0.406-0.405	1.8894-1.8888	0.312	0.125	—	12
3.50	2.10	1.71	1.50	0.88	0.500-0.499	2.1256-2.1250	0.312	0.125	—	15
3.65	2.33	1.93	1.63	0.94	0.500-0.499	2.5193-2.5185	0.312	0.125	—	17
4.03	2.71	1.98	1.72	1.03	0.625-0.624	2.5193-2.5185	0.312	0.188	—	20
4.45	2.89	2.36	1.94	1.19	0.750-0.749	3.1492-3.1482	0.375	0.188	—	25
4.86	3.05	2.36	1.94	1.19	0.999-1.000	3.1492-3.1482	0.375	0.250	—	30
6.68	4.47	4.01	3.22	1.97	1.375-1.374	4.8025-4.8015	0.500	0.313	—	45

NOTE: When selecting the bearing support for an application with high axial loads, the capacities of the bearings and locknuts must be considered.

E	F	G	H	J	K Shaft Dia.	L	M	P	Q	END CODE
—	—	1.00	—	0.40	—	1.3775 1.3770	0.188	—	0.13	7
—	—	1.00	—	0.40	—	1.3775 1.3770	0.188	—	0.13	8
—	—	1.00	—	0.44	—	1.4957 1.4951	0.188	—	0.13	9
—	—	1.00	—	0.44	—	1.4957 1.4951	0.190	—	0.13	10
—	—	1.15	—	0.55	—	1.8894 1.8888	0.312	—	0.13	12
—	—	1.25	—	0.63	—	2.1256 2.1250	0.312	—	0.20	15
—	—	1.32	—	0.63	—	2.5193 2.5185	0.312	—	0.20	17
—	—	1.47	—	0.72	—	2.5193 2.5185	0.312	—	0.20	20
—	—	1.67	—	0.76	—	3.1492 3.1482	0.375	—	0.25	25
—	—	1.67	—	0.76	—	3.1492 3.1482	0.375	—	0.25	30
—	—	2.50	—	1.25	—	4.8025-4.8015	0.500	—	0.50	45

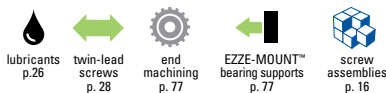

EZZE-MOUNT™ UNIVERSAL MOUNT BEARING SUPPORT WITH MOTOR MOUNT

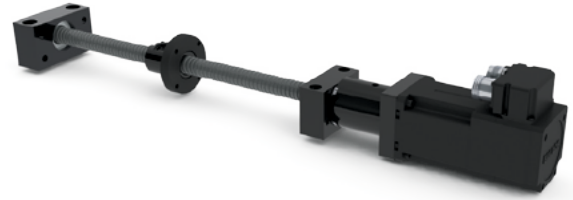

Universal Mount with motor mount includes an EZZE-MOUNT block with a motor mount for easy, accurate installation of ball screw and acme screw assemblies.

EXAMPLE:
1000-0250 SRT RH / U3 / 4N / 41.87 / SBN7508 / FS

EZM-2020-34

NOTE: When selecting the bearing support for an application with high axial loads, the capacities of the bearings and locknuts must be considered.

EXAMPLES OF EZM DESIGNATIONS:

U1, U2, U3 or U4 = Standard Mount available above
UX = modified, further explanation needed (i.e.: Special Frame)

Part No.	Ref. Code	Nema Frame Ref.	AA	BB	T	U	S	Y	W	AK	AJ	TAP	R
EZM-1008-17	U1	17	1.75	0.25	3.35	0.25	0.094	1.75	0.52	.868/0.871	1.725	#8-32	0.19
EZM-1009-23	U2	23	2.50	0.19	4.10	0.38	0.125	2.50	0.38	1.503/1.506	2.625	#10-32	0.26
EZM-3010-23	U2	23	2.50	0.19	4.10	0.38	0.125	2.50	0.38	1.503/1.506	2.625	#10-32	0.26
EZM-3012-23	U2	23	2.50	0.19	4.48	0.38	0.125	2.50	0.38	1.503/1.506	2.625	#10-32	0.10
EZM-3012-34	U3	34	3.25	0.16	4.92	0.50	0.125	2.50	0.81	2.878/2.882	3.875	#10-32	0.10
EZM-3015-23	U2	23	2.50	0.19	4.90	0.38	0.125	2.50	0.54	1.503/1.506	2.625	#10-32	-
EZM-3015-34	U3	34	3.25	0.16	5.13	0.50	0.125	2.50	0.81	2.878/2.882	3.875	#10-32	0.19
EZM-3017-34	U3	34	3.25	0.16	5.56	0.50	0.125	3.12	0.81	2.878/2.882	3.875	#10-32	0.13
EZM-3017-42	U4	42	4.50	0.19	6.31	0.63	0.188	3.12	1.56	2.504/2.508	5.000	¼"-20	0.13
EZM-2020-34	U3	34	3.44	0.16	5.96	0.50	0.125	3.44	0.81	2.878/2.882	3.875	#10-32	0.10
EZM-2020-42	U4	42	4.50	0.19	6.71	0.63	0.188	3.44	1.56	2.504/2.508	5.000	¼"-20	0.10
EZM-3025-34	U3	34	4.00	0.16	6.44	0.50	0.125	4.38	0.81	2.878/2.882	3.875	#10-32	0.31
EZM-3025-42	U4	42	4.50	0.19	7.17	0.63	0.188	4.38	1.56	2.504/2.508	5.000	¼"-20	0.31
EZM-2030-34	U3	34	4.00	0.16	6.97	0.50	0.125	4.38	0.81	2.878/2.882	3.875	#10-32	0.31
EZM-2030-42	U4	42	4.50	0.19	7.72	0.63	0.188	4.38	1.56	2.504/2.508	5.000	¼"-20	0.31
EZM-2030-56	U5	56C	6.63 dia.	0.19	7.78	0.63	0.188	4.38	1.62	4.502/4.506	5.875	0.41 dia. thru	0.31

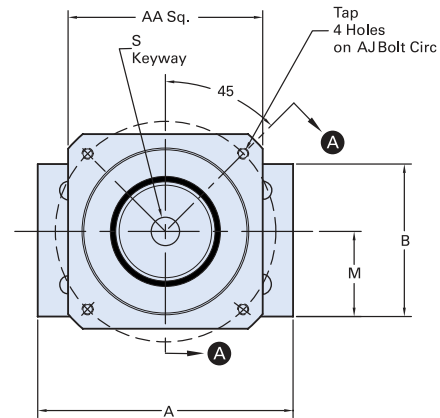
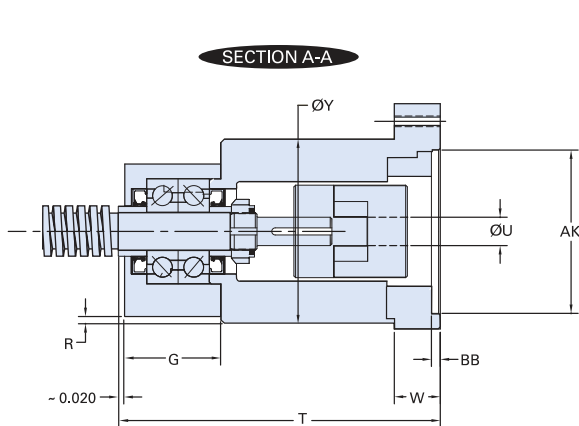

EZZE-MOUNT™ UNIVERSAL MOUNT BEARING SUPPORT WITH FLANGE MOUNT

Flange Mount with motor mount includes an EZZE-MOUNT block with a motor mount for easy, accurate installation of ball screw and acme screw assemblies.

NOTE: When selecting the bearing support for an application with high axial loads, the capacities of the bearings and locknuts must be considered.

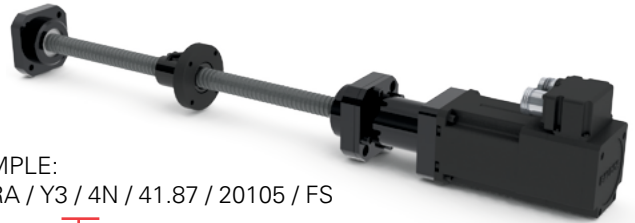

EXAMPLE:
105-RA / Y3 / 4N / 41.87 / 20105 / FS

EZF-3017-34





EXAMPLES OF EZF DESIGNATIONS:

Y1, Y2, Y3, Y4 = Standard Mount available above
YX = modified, further description needed (i.e.: Special Frame)

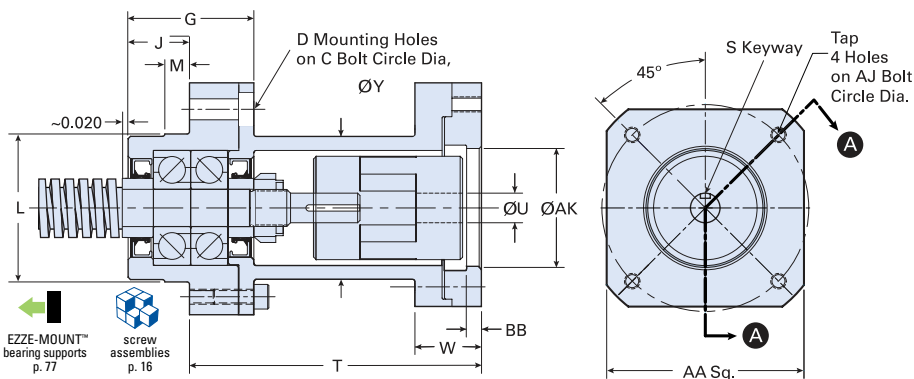
Part No.	Ref. Code	Nema Frame Ref.	AA	BB	T	U	S	Y	W	AK	AJ	TAP
EZF-1008-17	Y1	17	1.75	0.25	2.84	0.25	0.094	2.2	0.52	.868/871	1.725	#8-32
EZF-1009-23	Y2	23	2.50	0.19	3.41	0.38	0.125	2.1	0.88	1.503/1.506	2.625	#10-32
EZF-3010-23	Y2	23	2.50	0.19	3.41	0.38	0.125	2.1	0.88	1.503/1.506	2.625	#10-32
EZF-3012-23	Y2	23	2.50	0.19	3.70	0.38	0.125	1.81	0.88	1.503/1.506	2.625	#10-32
EZF-3012-34	Y3	34	3.25	0.16	4.14	0.50	0.125	1.81	1.31	2.878/2.882	3.875	#10-32
EZF-3015-23	Y2	23	2.50	0.19	3.84	0.38	0.125	1.98	0.88	1.503/1.506	2.625	#10-32
EZF-3015-34	Y3	34	3.25	0.16	4.36	0.50	0.125	1.98	1.31	2.878/2.882	3.875	#10-32
EZF-3017-34	Y3	34	3.25	0.16	4.62	0.50	0.125	2.25	1.67	2.878/2.882	3.875	#10-32
EZF-3017-42	Y4	42	4.50	0.19	5.37	0.63	0.188	2.25	2.41	2.504/2.508	5.000	¼"-20
EZF-2020-34	Y3	34	3.44	0.16	4.92	0.50	0.125	2.37	1.67	2.878/2.882	3.875	#10-32
EZF-2020-42	Y4	42	4.50	0.19	5.67	0.63	0.188	2.37	2.41	2.504/2.508	5.000	¼"-20
EZF-3025-34	Y3	34	4.00	0.16	5.24	0.50	0.125	3.00	1.67	2.878/2.882	3.875	#10-32
EZF-3025-42	Y4	42	4.50	0.19	5.98	0.63	0.188	3.00	2.41	2.504/2.508	5.000	¼"-20
EZF-2030-34	Y3	34	4.00	0.16	5.78	0.50	0.125	3.00	1.67	2.878/2.882	3.875	#10-32
EZF-2030-42	Y4	42	4.50	0.19	6.53	0.63	0.188	3.00	2.41	2.504/2.508	5.000	¼"-20
EZF-2030-56	Y5	56C	6.63 dia.	0.19	6.60	0.63	0.188	3.00	2.42	4.502/4.506	5.875	0.41 dia. thru
EZF-3035-56	Y5	56C	6.63 dia.	0.19	7.54	0.63	0.188	4.50	2.50	4.502-4.506	5.875	0.41 dia. thru

SECTION A-A



-  lubricants p.26
-  twin-lead screws p.28
-  end machining p.77
-  EZZE-MOUNT™ bearing supports p.77
-  screw assemblies p.16

LINEAR MOTION APPLICATIONS

High Quality, Precision Linear Motion Solutions

LIFE SCIENCES



- Auto samplers
- Syringe pumps
- Microscopes
- MRI scanners
- CT scanners
- Radiographic machines
- In-vitro diagnostics
- Genomics
- Blood gas chemistry

PRINTING & BINDING



- "Z" axis actuators
- Multi-axis gantries
- 3D printing
- Automation / Material handling
- Additive manufacturing (AD)
- Large format sign printing
- Digital offset printing process
- Folding and sealing equipment
- Thermal CTP systems

SECURITY - MILITARY



- Automated door locking systems
- Pan-tilt-zoom cameras
- Automated gates
- Tactical automated security cameras
- Missile fin actuation
- Tank sighting systems
- Drones and UAVs
- Torpedo fin actuation
- Guided munitions

SEMICONDUCTOR



- Burnishing stages
- Stacking systems
- Vision inspection machines
- X, Y, Z gantries
- Wafer elevators / Wafer handling
- Acoustic microscopes
- Ultrasonic imaging
- Tuning coils
- Vacuum chamber doors