

BSA **BALL SCREW STEPPER MOTOR
LINEAR ACTUATORS**

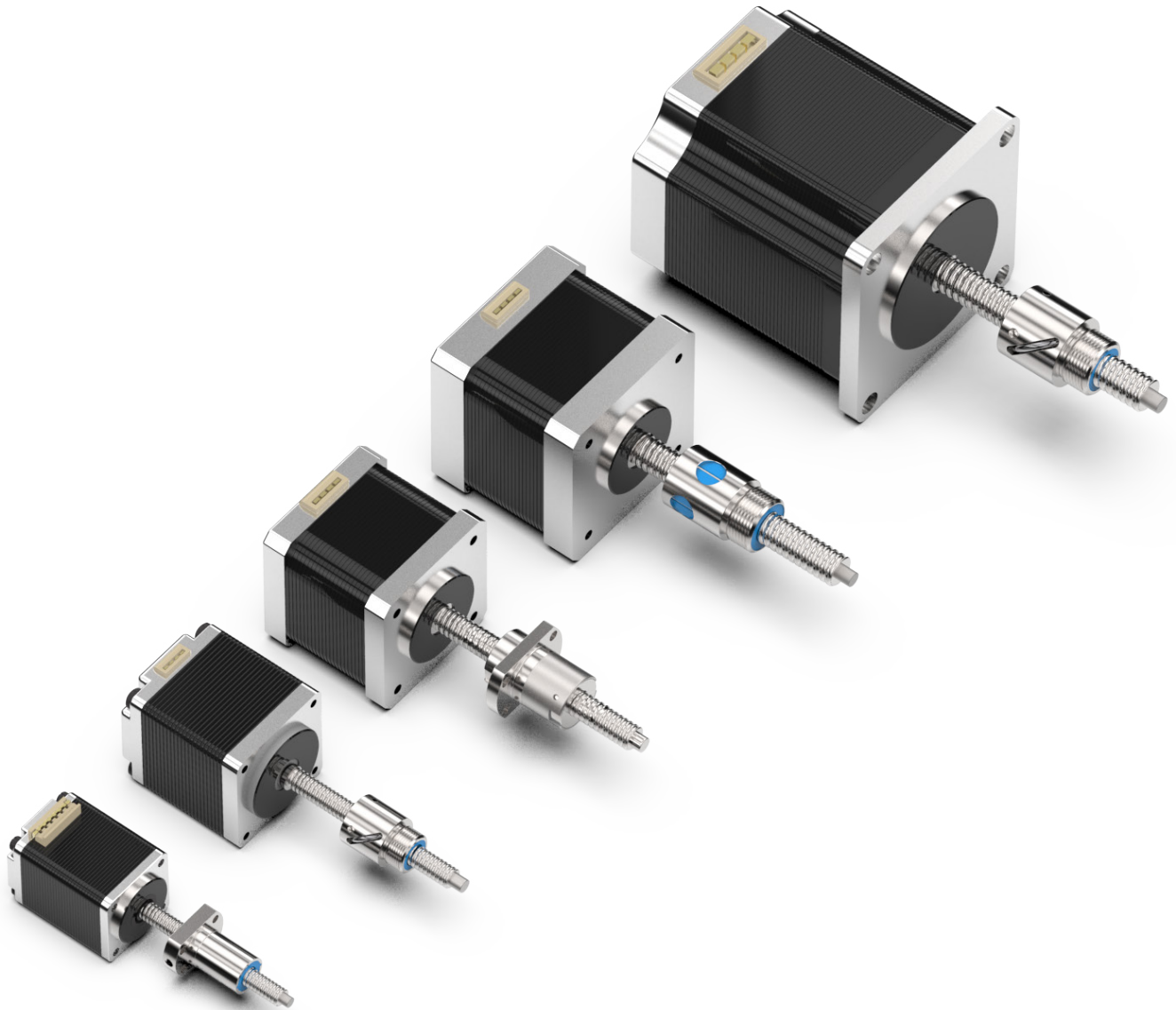



Helix Linear Technologies, Inc., Beachwood, Ohio USA

Helix Linear Technologies is the most high-tech lead screw manufacturing facility globally, producing the broadest product line of any lead screw manufacturer. We offer precision rolled, milled, and ground screws in diameters from 1.6 mm to 152.4 mm and leads from .3 mm to 75 mm. When you need Acme, Trapezoidal, or high-helix lead screws with precision low-backlash nuts, or a state-of-the-art anti-backlash design, we deliver the highest quality coupled with exceptional value.

Helix Linear Technologies offers a complete line of nuts in standard, anti-backlash, or custom designs with centralizing threads to match our precision lead screws, making our assemblies the lowest backlash product on the market. Our nuts come in various materials, including Acetal, PEEK, Bronze, Ertalyte, Carbon-Filled HPV, Turcite, Torlon, Vespel, PAI, PVDF, and medical-grade Acetal to fit your specific use and environment.

CULTURE

Our culture is rooted in teamwork and consists of smart, happy, and competitive professionals focused on manufacturing innovative products and delivering precise electromechanical linear motion solutions. We are in the people business, as well as the product business. Our talented employees make and sell our products, and our extraordinary scope of teamwork keeps our company healthy.

OPERATIONS

Our company delivers high-quality products and offers world-class engineering support, solving the most demanding linear motion applications across multiple industries. We manufacture components and subsystem solutions to high volume OEMs and custom machine builders to ensuring their success.

COMPANY

Helix Linear Technologies is a global supplier in the medical device, life science, security, semiconductor, aerospace, electromechanical, and defense industries. Leading the linear motion industry by manufacturing the highest quality linear actuation solutions in the world, we focus on helping our customers be productive and profitable. Our innovative product design solves real-world linear motion issues and builds a foundation for long term success.

HISTORY

Helix Linear Technologies was founded in 2011 to meet the demand for high-quality lead screws in the growing electromechanical actuation industry. Our rapid growth has included the addition of end-to-end linear actuator solutions, providing integrated solutions.

INDEX

Ball Screw Stepper Motor Linear Actuator Ordering Guide.....	2
Helix Quality Control.....	3
Glossary and Technical Data	4-5
NEMA 8 Ball Screw Stepper Motor Actuators.....	6-7
NEMA 11 Ball Screw Stepper Motor Actuators.....	8-9
NEMA 14 Ball Screw Stepper Motor Actuators.....	10-11
NEMA 17 Ball Screw Stepper Motor Actuators.....	12-13
NEMA 23 Ball Screw Stepper Motor Actuators.....	14-15
NEMA 34 Ball Screw Stepper Motor Actuators.....	16-17
Ball Screw Nut Availability Tables.....	18
Ball Screw Stepper Motor Actuator Curves.....	19-20

PARTNERS

CERTIFICATIONS



ORDERING GUIDE

BALL SCREW STEPPER MOTOR LINEAR ACTUATORS - BSA

BSA - 8 S 2.5 - E - B04010 - FB - A - 8.25 - 8N - E200 - A

Series	Motor Size	Motor Length	Voltage	Actuator Style	Ball Screw Size and Nut Style* (Motor Size)	A/B Nut Direction*	Ball Screw Length (Inch)	End Code/ Bearing Support	Encoder	Encoder Position
BSA Ball Screw Stepper Actuator	8	S Single Stack Only	See product page for rated voltage availability	E External Rotating Screw	NEMA 8 B04010-FB (4x1) B05020-FG (5x2) B05030-FG (5x3)	A Direction is thread/flange facing away from motor.	Length (inch) Example: 8.25"	00 No End Machining	00 No Encoder	0 N/A
		11			NEMA 11 B05020-FG (5x2) B05030-FG (5x3) B06010-FB (6x1) B06020-FG (6x2) B06060-FG (6x6)					
	14	S Single			NEMA 14 B08010-FG (8x1) B08010-FB (8x1) B08020-FG (8x2) B08020-FB (8x2) B08050-FG (8x5) B08080-FG (8x8) B08120-FB (8x12)					
		D Double			NEMA 17 B08010-FG (8x1) B08010-FB (8x1) B08020-FG (8x2) B08020-FB (8x2) B08050-FG (8x5) B08080-FG (8x8) B08120-FB (8x12)					
	23	S Single Stack Only			NEMA 23 B10020-FG (10x2) B10030-FG (10x3) B10040-FG (10x4) B10100-FG (10x10) B12020-FG (12x2) B12020-FB (12x2) B12040-FG (12x4) B12040-FB (12x4)					
34	S Single Stack Only	NEMA 34 B16020-FG (16x2) B16050-FG (16x5) B16100-FG (16x10) B16160-FG (16x16) B16500-FB (16x50)	B Direction is flange facing towards motor (threaded nuts will only be direction A)	8N Ball Screw Standard End	E500 500 CPR	B Down				
								E1000 1000 CPR		

*FB is flanged and FG is threaded. Ball screw size and lead dictates flanged or threaded option. Only the options shown are available.

ENCODER POSITION

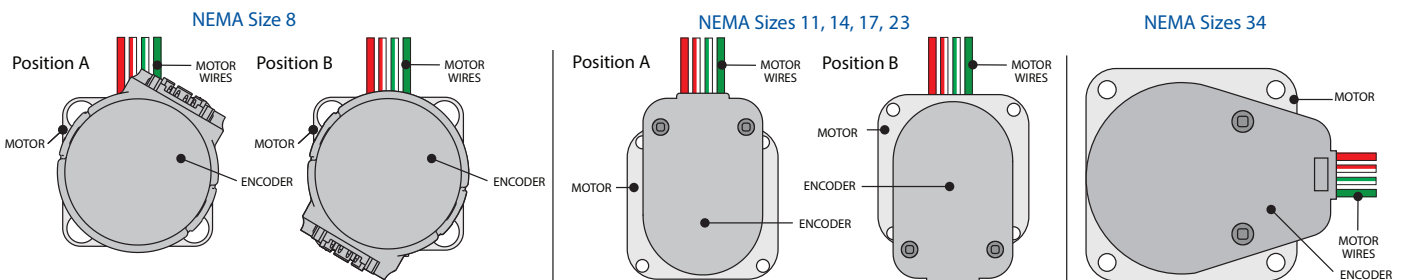

HIGH-TECH QUALITY EXPERIENCE

When you select Helix Linear Technologies as a supplier, you can be assured that your product will be designed and tested to rigorous product planning. Pre-design activity includes understanding of customer requirements applied to predictive models, engineering calculations and linear modeling through prototype development, stereo-lithography samples of form, fit, and function that verify design criteria.

VALIDATION AND VERIFICATION

Through years of rigorous development, Helix has proven its designs and manufacturing processes against the most stringent standards and specifications. Design and process verification and validation tools are employed throughout the product life cycle.

CERTIFICATIONS

Helix serves many customers in the Aerospace and Medical device markets and has complied with common Quality System Requirements.

QUALITY TOOLS

- Design for Six Sigma manufacturing
- D.O.E. (Design of Experiments)
- APQP (Advanced Product Quality Planning)
- DFMEA, PFEMA
- FEA (Finite Element Analysis)
- DVP&R (Design Verification Plan & Report)
- Reliability Testing
- Process validation to 21 CFR Part 82 (Medical Device)



Helix Linear Technologies lead screws in use in a multi-channel pipetting application.

INSPECTION CAPABILITIES

Laser Lead Measurement - Precise lead error gauging is utilized to validate processes to conform to Helix internal specifications and customer requirements.

Roundness Measurement - Critical to quality, characteristics such as roundness are monitored throughout the screw manufacturing process.

Contour Readers - Prior to the start of any production run, thread form geometry is precisely measured to stringent engineering specifications.

Metallurgical Lab - The metallurgical lab is capable of determining material composition from raw materials to final product. A micro-hardness and case depth inspection is a routine check that validates the heat treat processes when required.



Helix Linear Technologies lead in use in medical lab testing device.

TESTING CAPABILITIES

Efficiency Measurement - Helix designs test machines to measure and validate screw assembly efficiency.

Torque Measurement - Preloaded lead screw assemblies are evaluated to determine compliance with engineering specifications utilizing a Dynamic Torque Testing Machine.

FUNCTIONAL TESTING

Helix test systems and engineered testing processes perform analysis, verification, and solidification of life, durability, and performance. Functional testing defines operating limits in specifications and sets defined targets in product launch process and assurance plans. Engineered testing provides predictive tools, generates data for prognostics, and validates performance wear models. Life tests help performance in multiple operating conditions. Helix offers proof testing for customers to help accelerate product release dates.

GLOSSARY AND TECHNICAL DATA

BALL SCREW THREAD FORM TERMS

INTRODUCTION - Ball screws offer an efficient means of converting rotary motion to linear motion. A ball screw is an improvement over an acme screw just as an antifriction ball bearing is an improvement over a plain bushing. Ball screw assemblies have a number of bearing balls that transfer the load between the nut and screw. The thread form in which the bearing balls ride is an ogival shape formed from two arcs of the same radius with offset centers. This form is also referred to as a gothic arch. *See below.*

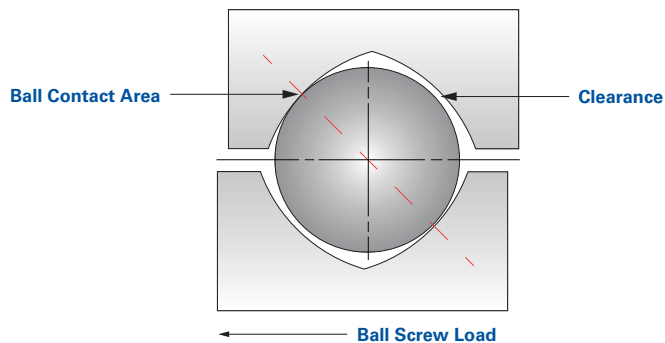

Ball Circle Diameter - The diameter of the circle generated by the center of the bearing balls when in contact with the screw and nut.

Root Diameter - The diameter of the screw measured at the bottom of the thread. This is the diameter used for column strength, critical speed calculations and end machining considerations.

Pitch - The axial distance between threads. Pitch is equal to the lead in a single start screw.

Lead - The axial distance the nut advances in one revolution of the screw. The lead is equal to the pitch times the number of starts.

$$\text{PITCH} \times \text{STARTS} = \text{LEAD}$$

Screw Starts - The number of independent threads on the screw shaft; typically one, two or four.

Lead Accuracy - Lead accuracy is the difference between the actual distance traveled versus the theoretical distance traveled based on lead.

Bearing Ball Circuit - The closed path that the bearing balls follow through the ball nut. Ball nuts have one or more circuits.

Return Guide - Component that allows the bearing ball to be picked up and returned to the beginning or end of the circuit.

Load Carrying Balls - The bearing balls in contact with ball nut and ball screw sharing the load.

Land Diameter - The outside diameter of the screw. This diameter is less than the ball circle diameter.

MATERIALS

Stainless Steel:

- 1.3505 (100Cr6)
- 1.1213 (Cf53)

On Request:

- Corrosion-resistant steel 1.4034 (X46Cr13)
- Other materials

On Request:

- Coating for corrosion protection

Please Note: *The use of corrosion-resistant steel results in lower load ratings Details on request.*

LEAD ACCURACY

Standard:

- G9 $\Delta \leq 0.1$ mm/300 mm (in accordance with DIN 690510)

On Request:

- G7 $\Delta \leq 0.052$ mm/300 mm
- G5 $\Delta \leq 0.023$ mm/300 mm

SINGLE START (LEAD = PITCH)

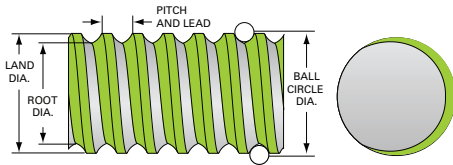

DOUBLE START (LEAD = 2 X PITCH)

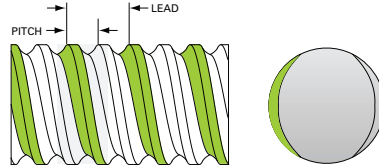

FOUR START (LEAD = 4 X PITCH)

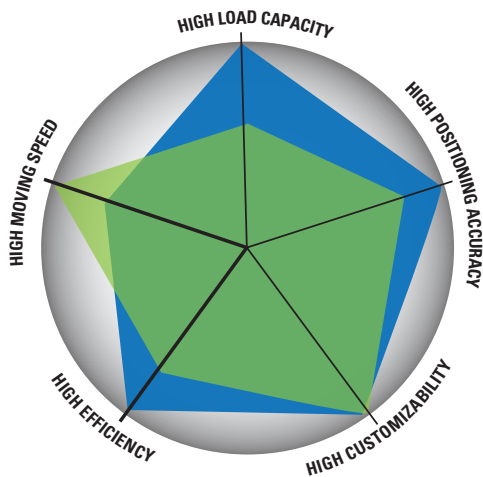
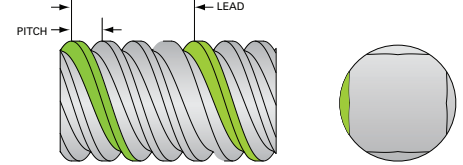

BALL SCREWS LEAD SCREWS

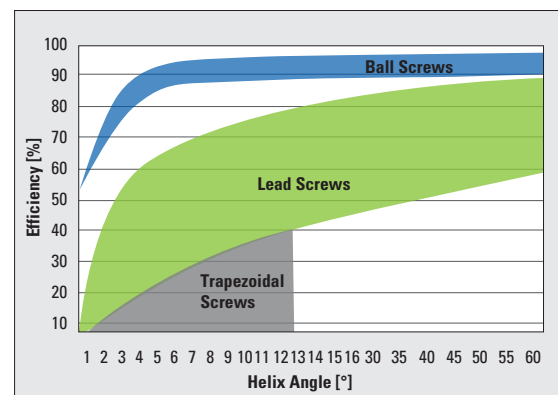

BALL SCREWS CHARACTERISTICS

- High load ratings, and are therefore suitable for high static and dynamic loads
- Excellent efficiency ($\mu > 0.9$), therefore:
- Low drive power required
- Low energy consumption
- Low self-heating
- Low-friction operation
- No stick-slip effect
- High accuracy for positioning and repetition
- High reliability and long service life with minimum need for maintenance
- Wipers available on request

LEAD SCREWS CHARACTERISTICS

- Small to medium load ratings, therefore suitable for low to medium loads
- Very high travelling speeds, thanks to over-square pitches ($p \leq 6 \times d$)
- High efficiency ($\mu \sim 0.5 \dots 0.8$), thanks to high surface quality of the steel leadscrews and nuts made of high-performance plastics
- Weight optimization possible based on aluminum screws
- Performance optimization sometimes possible based on coating
- High reliability and long service life with marginal need for maintenance

NEMA 8

Ball Screw Stepper Motor Linear Actuator with Ball Screw Nut

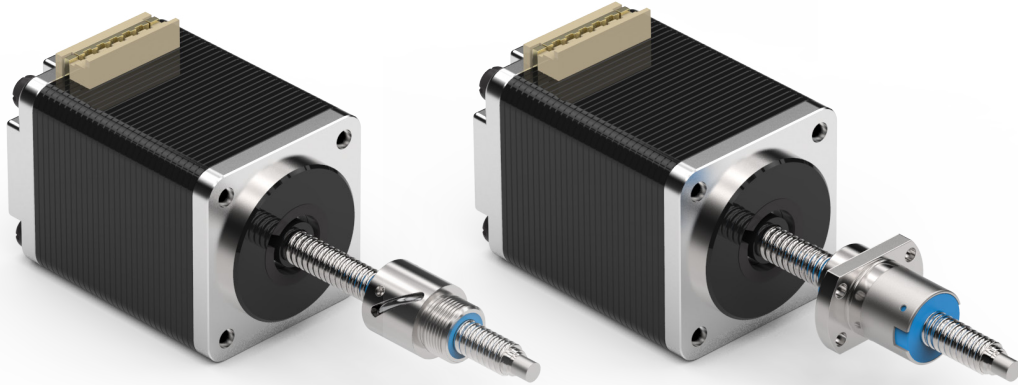

NEMA 8 External SMA Ball Screw and Ball Screw Nut Assembly

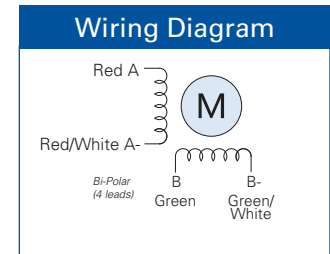
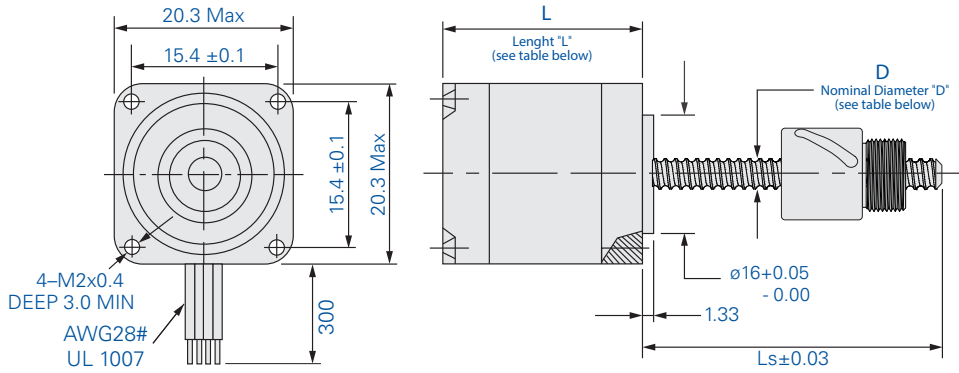

NEMA 8 Motor Specifications

Part Number	Operating Voltage (VDC)	Leads (Bipolar)	Step Angle (°) *	Rated Current (amp)	Resistance/Phase (Ω)	Inductance/Phase (mH)	Power Consumption (W)	Motor Weight (g)	Bearing Load Limit (N)	Length (mm)
BSA-8S2.5	2.50	4	1.8	0.49	5.1	1.5	2.45	43	65	30
BSA-8S5	5.00	4	1.8	0.24	20.4	5.0	2.45	43	65	30
BSA-8S7.5	7.50	4	1.8	0.16	45.9	11.7	2.45	43	65	30

*0.9° motors also available

NEMA 8 Ball Screws

Ball Screw Code	Nominal Diameter (mm)	Lead (mm)	Travel Per Step 1.8° (mm)	Ball Nut Dynamic Load (N)
4x1	4	1	0.0050	430
5x2	5	2	0.0100	500
5x3	5	3	0.0150	340

NEMA 8

Ball Screw Stepper Motor Linear Actuator with Ball Screw Nut

4x1 Ball Nut - Flanged

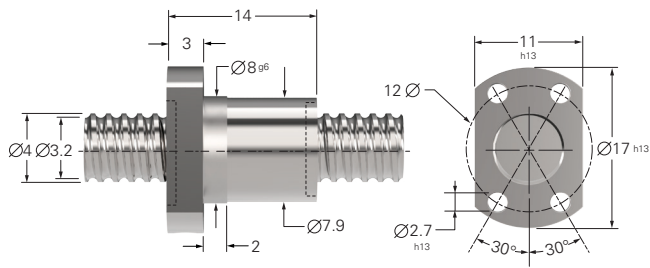

5x2 Ball Nut - Threaded

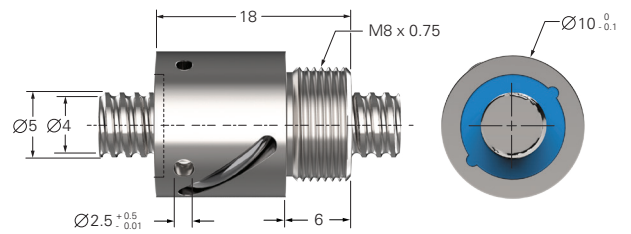

5x3 Ball Nut - Threaded

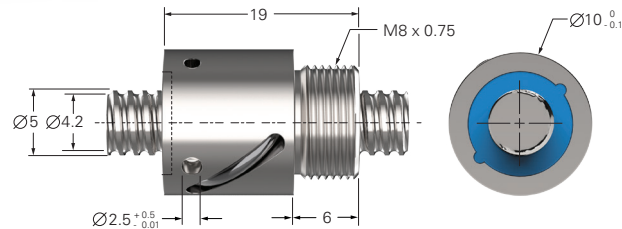

NEMA 8 Ball Screw End Machining

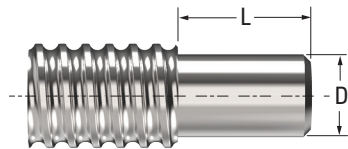

Motor Size	Thread (Dia. x Lead)	End Code	Diameter "D" (mm)	Length "L" (mm)
NEMA 8	4 x 1	8N	3	3
	5 x 2	8N	4	5
	5 x 3	8N	4	5

Custom end-machining options available upon request. Contact us today for details.

NEMA 8 Encoder

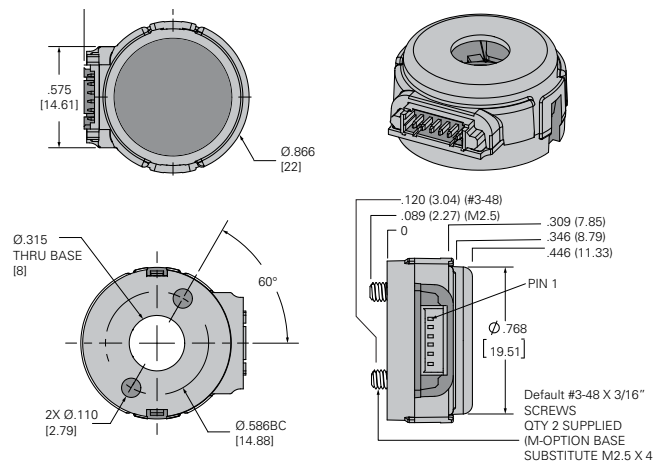

NEMA 11

Ball Screw Stepper Motor Linear Actuator with Ball Screw Nut

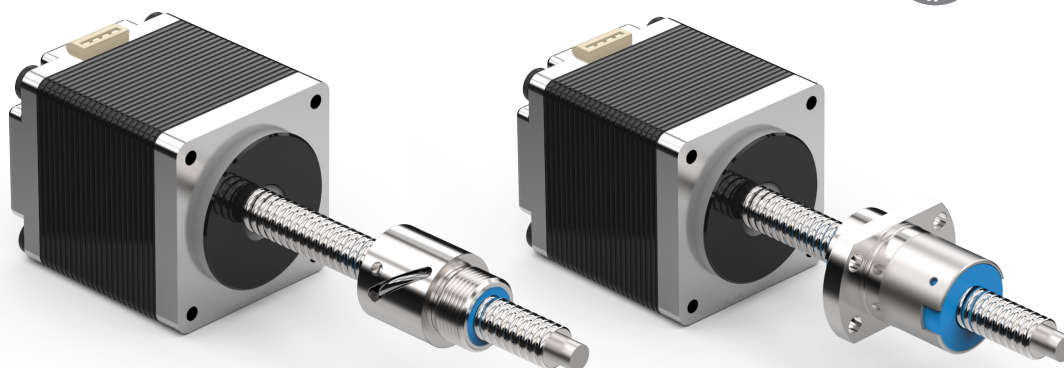

NEMA 11 External SMA Ball Screw and Ball Screw Nut Assembly

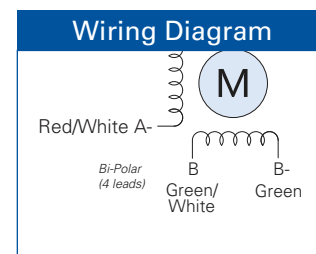
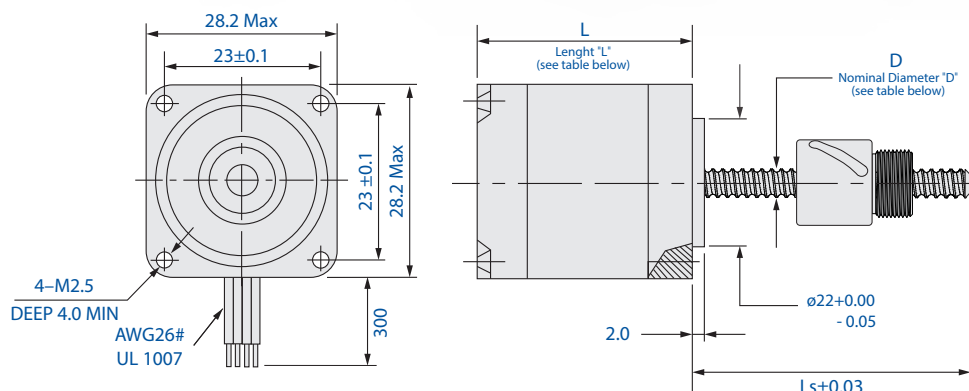

NEMA 11 Motor Specifications

Part Number	Operating Voltage (VDC)	Leads (Bipolar)	Step Angle (°)*	Rated Current (amp)	Resistance/Phase (Ω)	Inductance/Phase (mH)	Power Consumption (W)	Motor Weight (g)	Bearing Load Limit (N)	Length "L" (mm)
BSA-11S2.1	2.1	4	1.8	1.0	2.1	1.5	4.2	119	115	32.2
BSA-11S5	5	4	1.8	0.42	11.9	6.7	4.2	119	115	32.2
BSA-11S12	12	4	1.8	0.18	68.6	39	4.2	119	115	32.2
BSA-11D2.1	2.1	4	1.8	1.90	1.1	1.1	7.5	180	115	46
BSA-11D5	5	4	1.8	0.75	6.7	5.8	7.5	180	140	46
BSA-11D12	12	4	1.8	0.35	34.8	35.6	7.5	180	140	46

*0.9° motors also available

NEMA 11 Ball Screws

Ball Screw Code	Nominal Diameter "D" (mm)	Lead (mm)	Travel Per Step 1.8° (mm)	Ball Nut Dynamic Load Limit (N)
5x2	5	2.0	0.0100	500
5x3	5	3.0	0.0150	340
6x1	6	1.0	0.0050	600
6x2	6	2.0	0.0100	1700
6x6	6	6.0	0.0300	1700

NEMA 11

Ball Screw Stepper Motor Linear Actuator with Ball Screw Nut

5x2 Ball Nut - Threaded

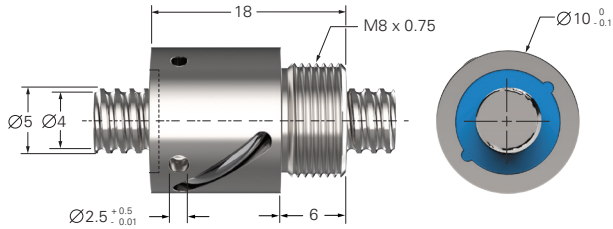

5x3 Ball Nut - Threaded

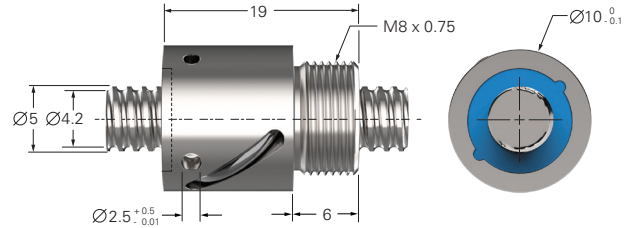

6x1 Ball Nut - Flanged

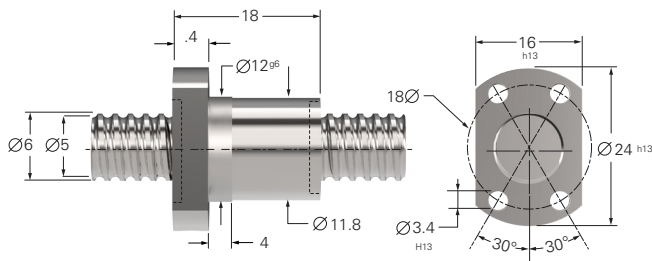

6x2 Ball Nut - Threaded

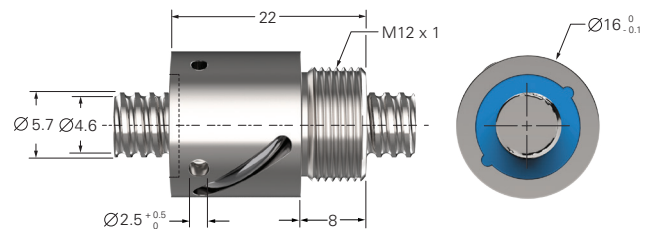

6x6 Ball Nut - Threaded

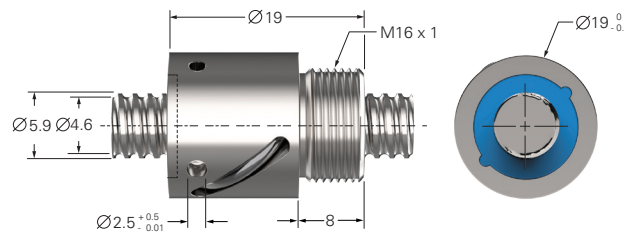

NEMA 11 Ball Screw End Machining

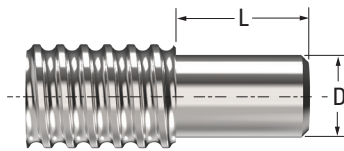

Motor Size	Thread (Dia. x Lead)	End Code	Diameter "D" (mm)	Length "L" (mm)
NEMA 11	5 x 2	8N	4	5
	5 x 3	8N	4	5
	6 x 1	8N	4	5
	6 x 2	8N	4	5
	6 x 6	8N	4	5

Custom end-machining options available upon request. Contact us today for details.

NEMA 11 Encoder

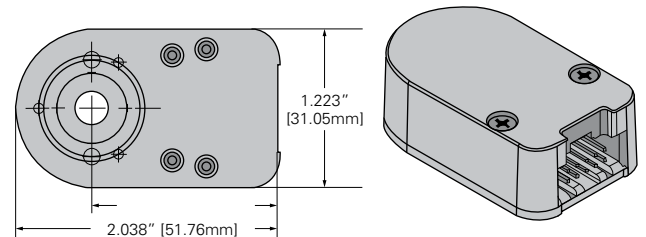
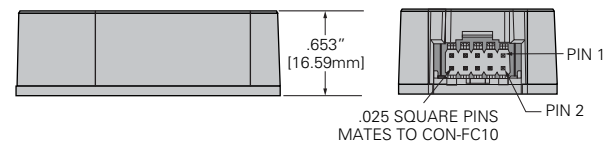

NEMA 14

Ball Screw Stepper Motor Linear Actuator with Ball Screw Nut

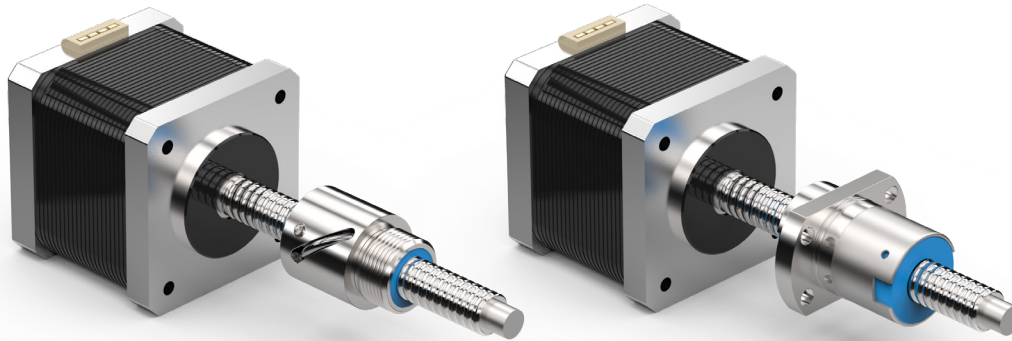

NEMA 14 External SMA Ball Screw and Ball Screw Nut Assembly

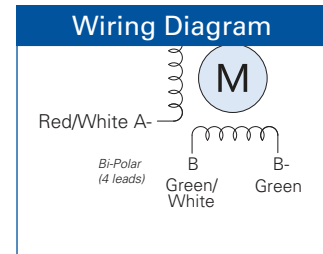
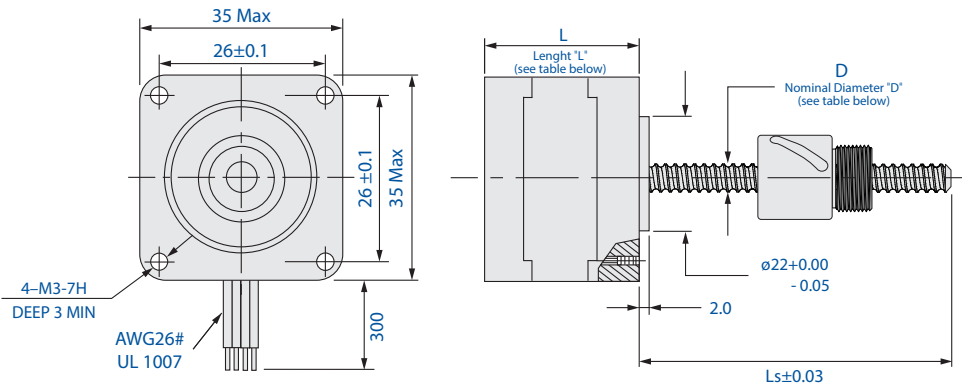

NEMA 14 Motor Specifications

Part Number	Operating Voltage (VDC)	Leads (Bipolar)	Step Angle (°)*	Rated Current (amp)	Resistance/Phase (Ω)	Inductance/Phase (mH)	Power Consumption (W)	Motor Weight (g)	Bearing Load Limit (N)	Length "L" (mm)
BSA-14S2.33	2.33	4	1.8	1.25	1.86	2.8	5.7	162	250	34.5
BSA-14S5	5	4	1.8	0.57	8.8	13	5.7	162	250	34.5
BSA-14S12	12	4	1.8	0.24	50.5	60	5.7	162	250	34.5
BSA-14D2.33	2.33	4	1.8	2.0	1.2	1.95	9.1	240	300	44.1
BSA-14D5	5	4	1.8	0.91	5.5	7.63	9.1	240	300	44.1
BSA-14D12	12	4	1.8	0.38	31.6	65.1	9.1	240	300	44.1

*0.9° motors also available

NEMA 14 Ball Screws

Ball Screw Code	Nominal Diameter "D" (mm)	Lead (mm)	Travel Per Step 1.8° (mm)	Ball Nut Dynamic Load Limit (N)
8x1	8	1	0.0050	700
8x2	8	2	0.0100	1400
8x5	8	5	0.0250	1960
8x8	8	8	0.0400	2000
8x12	8	12	0.0600	1400

HELIXLINEAR.COM

The specifications and data in this publication are believed to be accurate and reliable. However, it is the responsibility of the product user to determine the suitability of Helix products for a specific application. While defective products will be replaced without charge if promptly returned, no liability is assumed beyond such replacement.

NEMA 14

Ball Screw Stepper Motor Linear Actuator with Ball Screw Nut

8x1 Ball Nut - Threaded

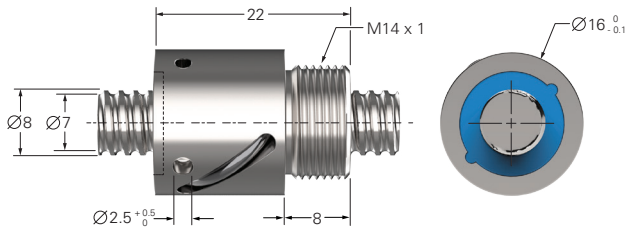

8x1 Ball Nut - Flanged

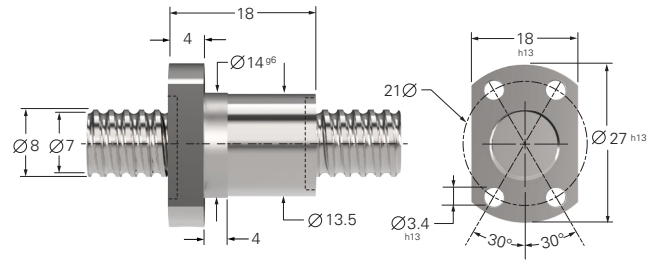

8x2 Ball Nut - Threaded

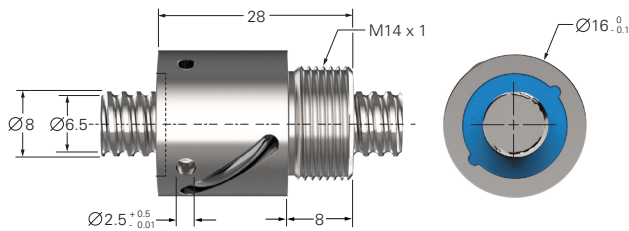

8x2 Ball Nut - Flanged

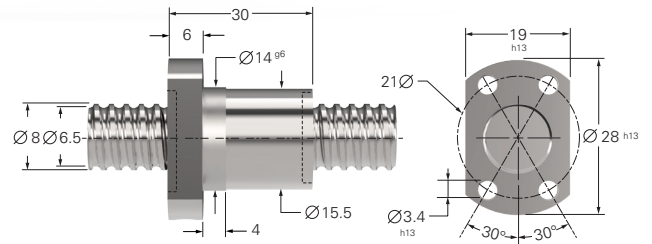

8x5 Ball Nut - Threaded

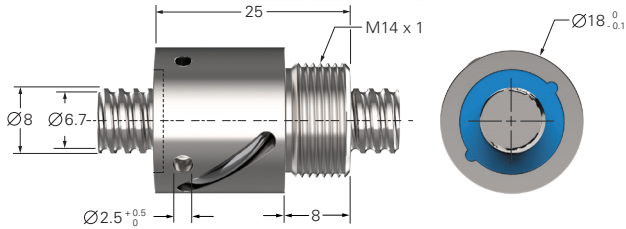

8x8 Ball Nut - Threaded

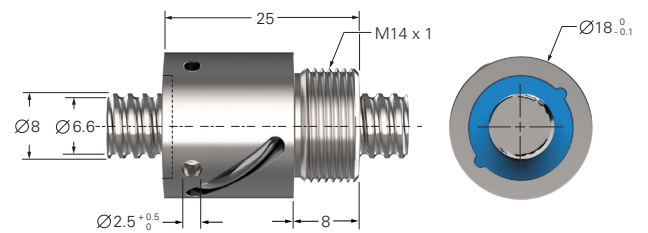

8x12 Ball Nut - Flanged

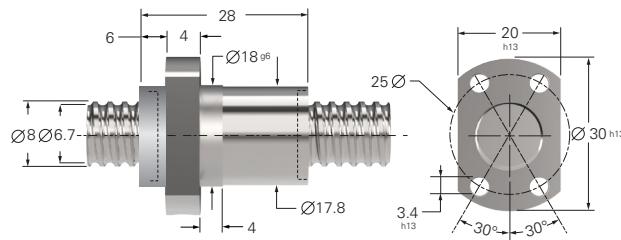

NEMA 14 Ball Screw End Machining

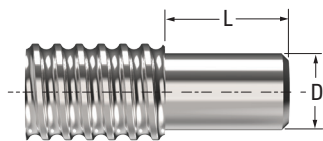

Motor Size	Thread (Dia. x Lead)	End Code	Diameter "D" (mm)	Length "L" (mm)
NEMA 14	8 x 1	8N	6	6
	8 x 2	8N	6	6
	8 x 5	8N	6	6
	8 x 8	8N	6	6
	8 x 12	8N	6	6

Custom end-machining options available upon request. Contact us today for details.

NEMA 14 Encoder

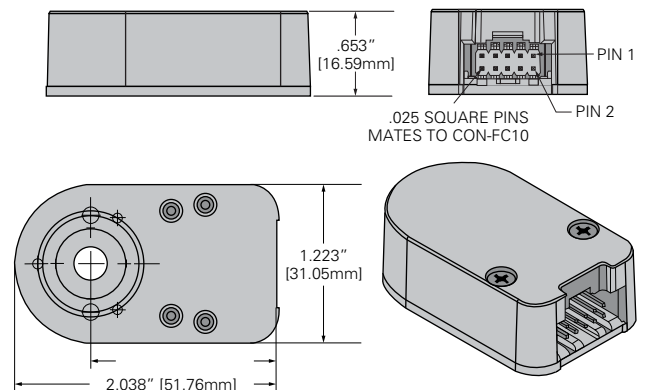

NEMA 17

Ball Screw Stepper Motor Linear Actuator with Ball Screw Nut

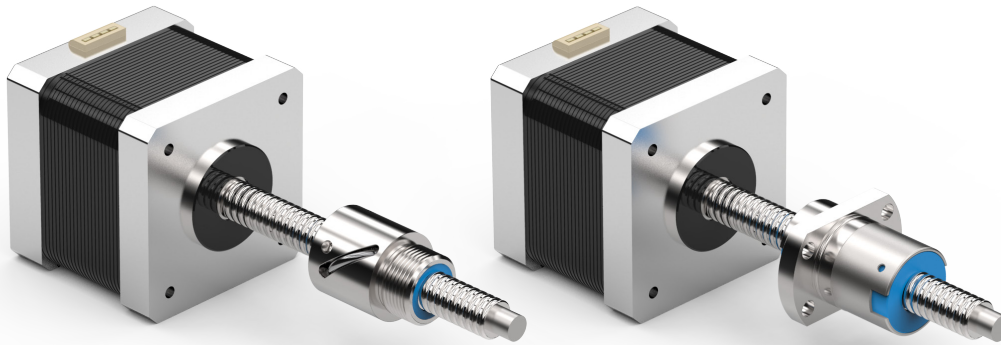

NEMA 17 External SMA Ball Screw and Ball Screw Nut Assembly

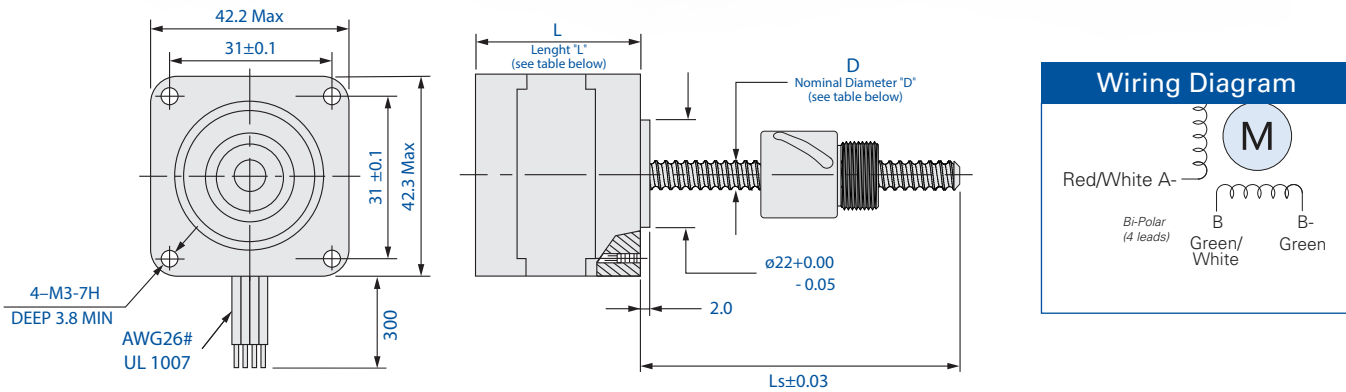

NEMA 17 Motor Specifications

Part Number	Operating Voltage (VDC)	Leads (Bipolar)	Step Angle (°)*	Rated Current (amp)	Resistance/Phase (Ω)	Inductance/Phase (mH)	Power Consumption (W)	Motor Weight (g)	Bearing Load Limit (N)	Length "L" (mm)
BSA17S2.33	2.33	4	1.8	1.50	1.56	1.9	7.0	241	250	33.8
BSA17S5	5	4	1.8	0.70	7.2	10.6	7.0	241	250	33.8
BSA17S12	12	4	1.8	0.29	41.5	73.3	7.0	241	250	33.8
BSA17D2.33	2.33	4	1.8	2.6	0.9	1.33	14.0	352	325	47.75
BSA17D5	5	4	1.8	1.3	3.8	6.6	14.0	352	325	47.75
BSA-17D12	12	4	1.8	0.55	21.9	45.1	14.0	352	325	47.75

*0.9° motors also available

NEMA 17 Ball Screws

Ball Screw Code	Nominal Diameter "D" (mm)	Lead (mm)	Travel Per Step 1.8° (mm)	Ball Nut Dynamic Load Limit (N)
8x1	8	1	0.0050	700
8x2	8	2	0.0100	1400
8x5	8	5	0.0300	1960
8x8	8	8	0.0400	2000
8x12	8	12	0.0600	300

NEMA 17

Ball Screw Stepper Motor Linear Actuator with Ball Screw Nut

8x1 Ball Nut - Threaded

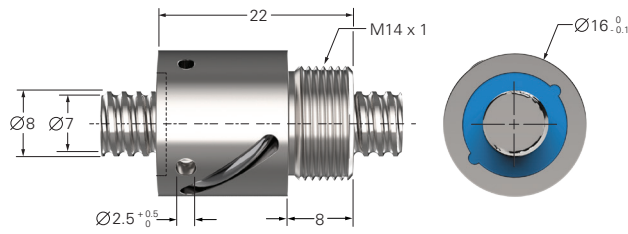

8x1 Ball Nut - Flanged

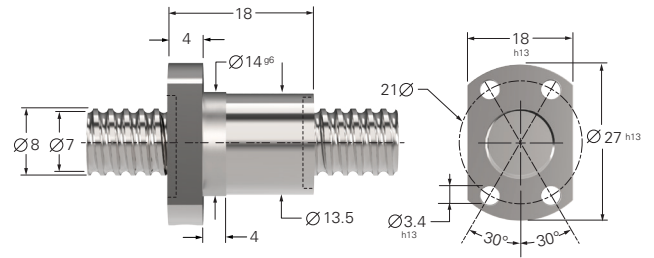

8x2 Ball Nut - Threaded

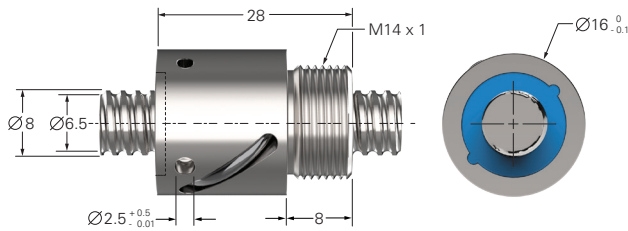

8x2 Ball Nut - Flanged

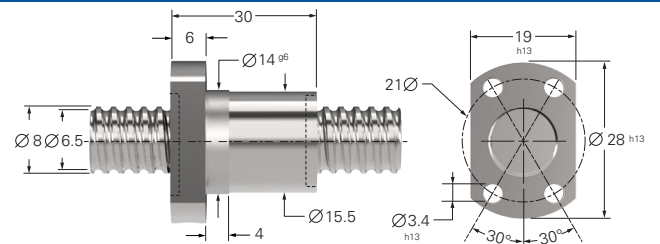

8x5 Ball Nut - Threaded

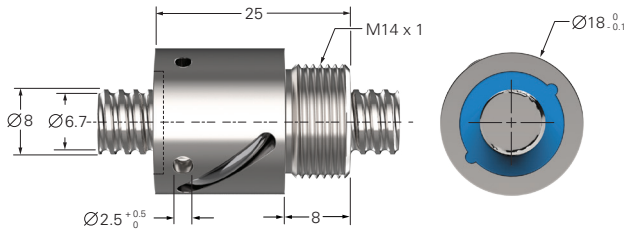

8x8 Ball Nut - Threaded

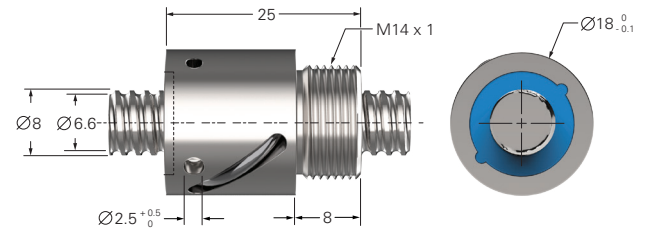

8x12 Ball Nut - Flanged

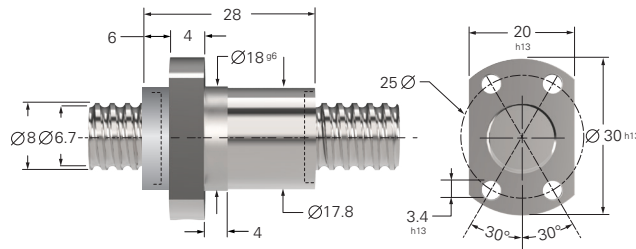

NEMA 17 Ball Screw End Machining

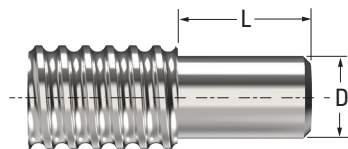

Motor Size	Thread (Dia. x Lead)	End Code	Diameter "D" (mm)	Length "L" (mm)
NEMA 17	8 x 1	8N	6	6
	8 x 2	8N	6	6
	8 x 5	8N	6	6
	8 x 8	8N	6	6
	8 x 12	8N	6	6

Custom end-machining options available upon request. Contact us today for details.

NEMA 17 Encoder

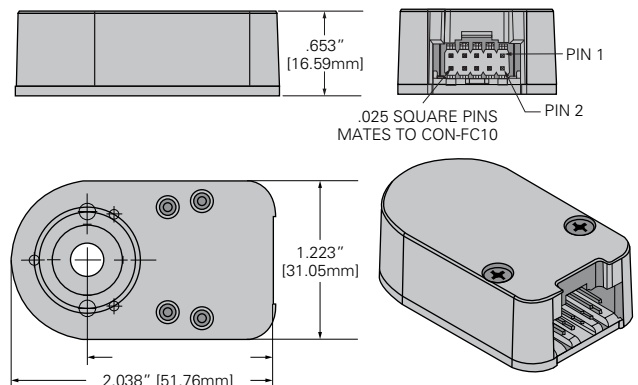

NEMA 23

Ball Screw Stepper Motor Linear Actuator with Ball Screw Nut



NEMA 23 External SMA Ball Screw and Ball Screw Nut Assembly

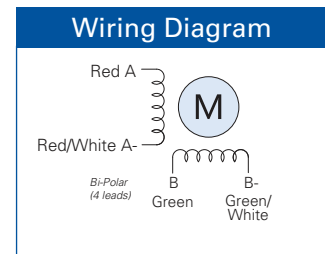
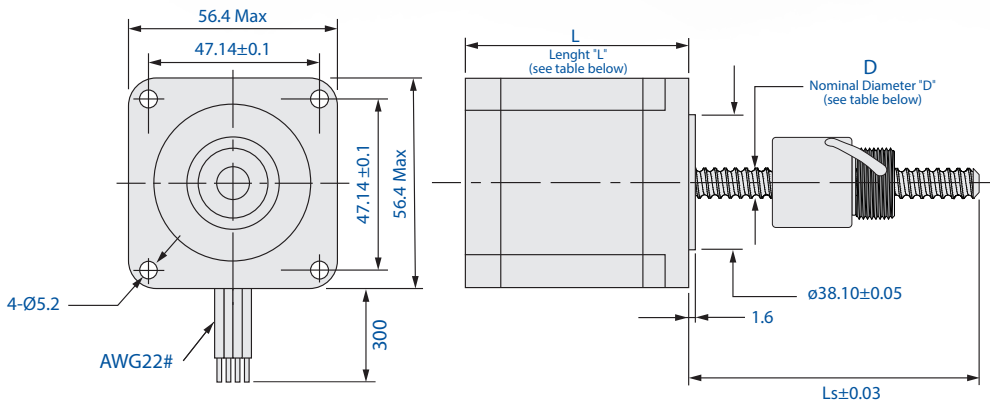

NEMA 23 Motor Specifications

Part Number	Operating Voltage (VDC)	Leads (Bipolar)	Step Angle (°)*	Rated Current (amp)	Resistance/Phase (Ω)	Inductance/Phase (mH)	Power Consumption (W)	Motor Weight (g)	Bearing Load Limit (N)	Length "L" (mm)
BSA-23S3.25	3.25	4	1.8	2.0	1.63	3.5	13	511	975	45.2
BSA-23S5	5	4	1.8	1.3	3.85	10.5	13	511	975	45.2
BSA-23S12	12	4	1.8	0.54	22.2	47	13	511	975	45.2
BSA-23D3.25	3.25	4	1.8	3.32	0.98	1.33	14	652	975	66
BSA-23D5	5	4	1.8	2.16	2.31	6.6	14	652	975	66
BSA-23D12	12	4	1.8°	0.90	13.33 Ω	45.1	14	652	975	66

*0.9° motors also available

NEMA 23 Ball Screws

Ball Screw Code	Nominal Diameter "D" (mm)	Lead (mm)	Travel Per Step 1.8° (mm)	Ball Nut Dynamic Load Limit (N)
10x2	10	2	0.0100	1250
10x3	10	3	0.0150	2400
10x4	10	4	0.0200	4100
10x10	10	10	0.0500	2500
12x2	12	2	0.0100	1380
12x4	12	4	0.0200	4000

HELIXLINEAR.COM

The specifications and data in this publication are believed to be accurate and reliable. However, it is the responsibility of the product user to determine the suitability of Helix products for a specific application. While defective products will be replaced without charge if promptly returned, no liability is assumed beyond such replacement.

NEMA 23

Ball Screw Stepper Motor Linear Actuator with Ball Screw Nut

10x2 Ball Nut - Threaded 10x3 Ball Nut - Threaded

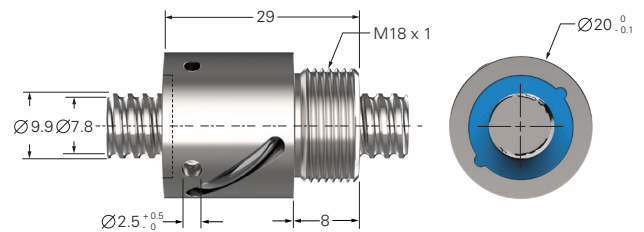
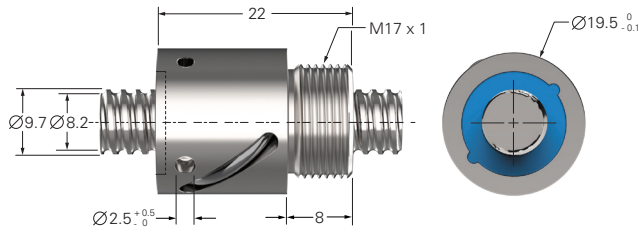

10x4 Ball Nut - Threaded 10x10 Ball Nut - Threaded

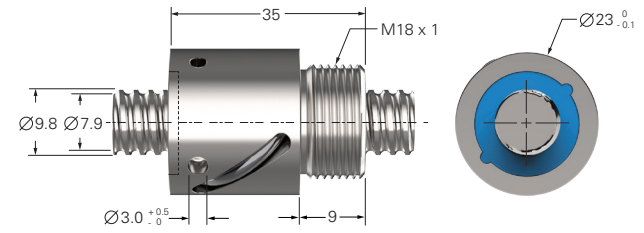
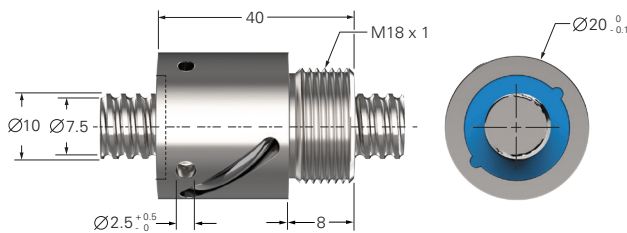

12x2 Ball Nut - Threaded 12x2 Ball Nut - Flanged

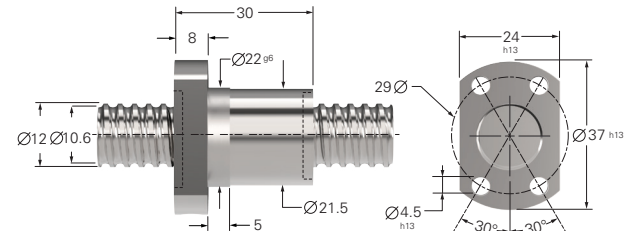
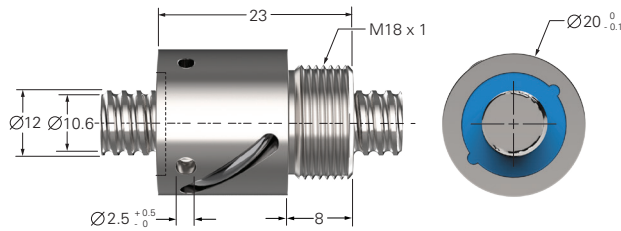

12x4 Ball Nut - Threaded 12x4 Ball Nut - Flanged

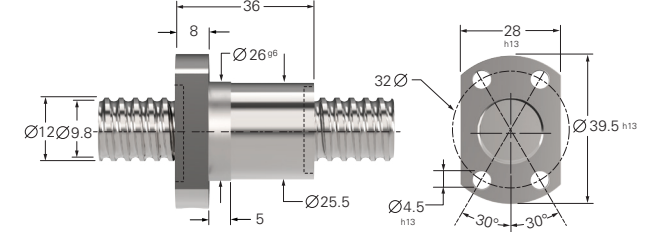
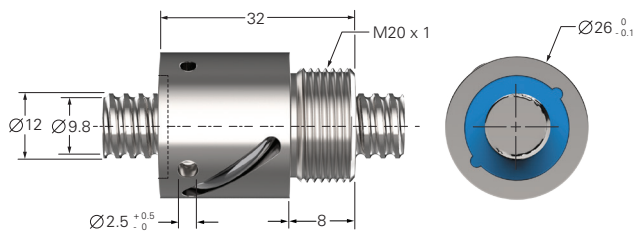

NEMA 23 Ball Screw End Machining NEMA 23 Encoder

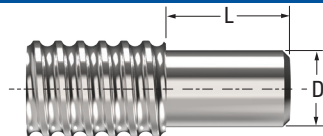

Motor Size	Thread (Dia. x Lead)	End Code	Diameter "D" (mm)	Length "L" (mm)
NEMA 23	10 x 2	8N	7	7
	10 x 3	8N	7	7
	10 x 4	8N	7	7
	10 x 10	8N	7	7
	12 x 2	8N	9	8
	12 x 4	8N	9	8

Custom end-machining options available upon request. Contact us today for details.

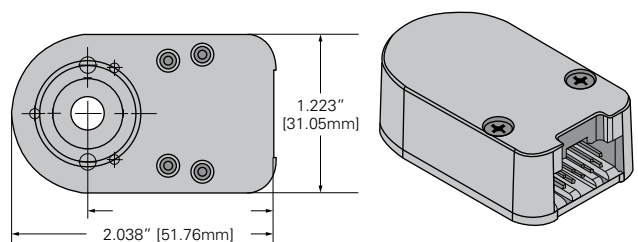
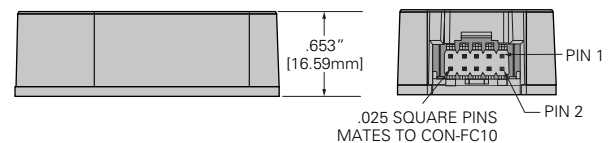

NEMA 34

Ball Screw Stepper Motor Linear Actuator with Ball Screw Nut



NEMA 34 External SMA Ball Screw and Ball Screw Nut Assembly

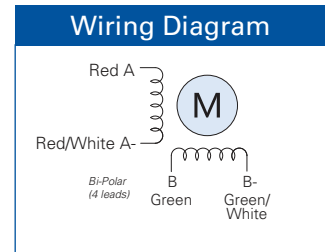
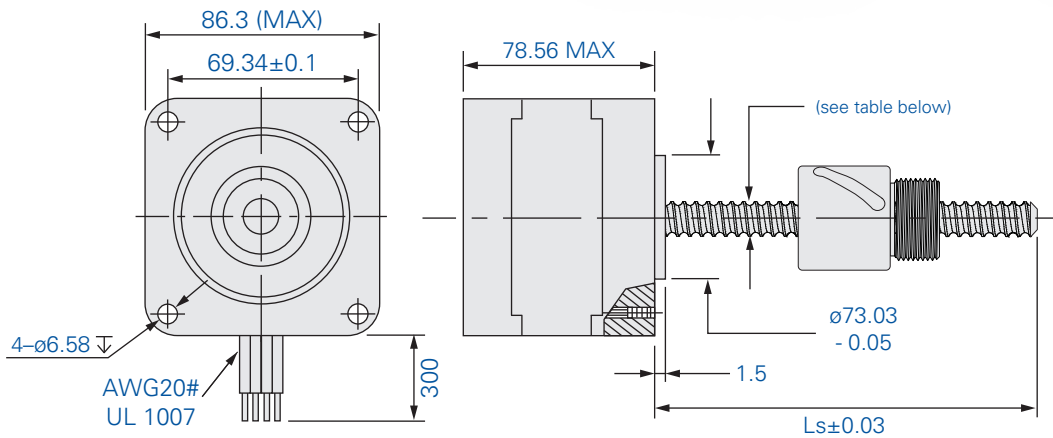

NEMA 34 Motor Specifications

Part Number	Operating Voltage (VDC)	Leads (Bipolar)	Step Angle (°)*	Rated Current (amp)	Resistance/Phase (Ω)	Inductance/Phase (mH)	Power Consumption (W)	Motor Weight (g)	Bearing Load Limit (N)	Length "L" (mm)
BSA-34S2.85	2.85	4	1.8	5.47	0.52	2.86	31.2	2300	2000	78.56
BSA-34S5	5	4	1.8	3.12	1.6	8.8	31.2	2300	2000	78.56
BSA-34S12	12	4	1.8	1.3	9.23	51	31.2	2300	2000	78.56

NEMA 34 Ball Screws

Ball Screw Code	Nominal Diameter (mm)	Lead (mm)	Travel per Pulse 1.8° (mm)	Ball Nut Dynamic Load Limit (N)
16x2	16	2	0.0100	2400
16x5	16	5	0.0250	9700
16x10	16	10	0.0500	8500
16x16	16	16	0.0800	9150
16x50	16	50	0.2500	4800

NEMA 34

Ball Screw Stepper Motor Linear Actuator with Ball Screw Nut

16x2 Ball Nut - Threaded 16x5 Ball Nut - Threaded

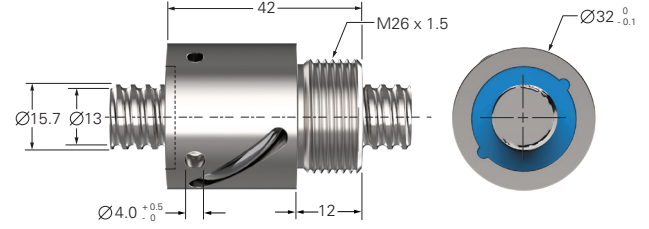
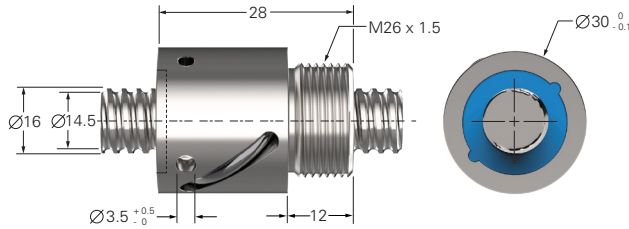

16x10 Ball Nut - Threaded 16x16 Ball Nut - Threaded

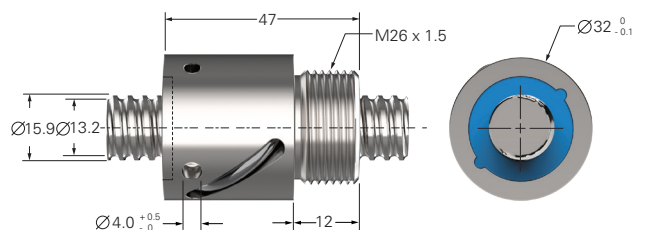
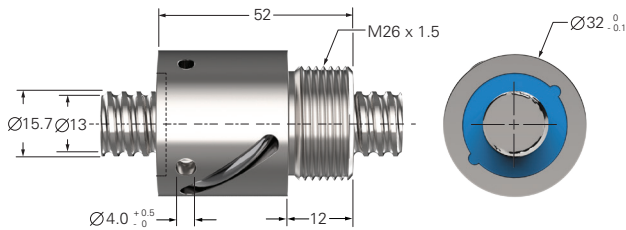

16x50 Ball Nut - Flanged

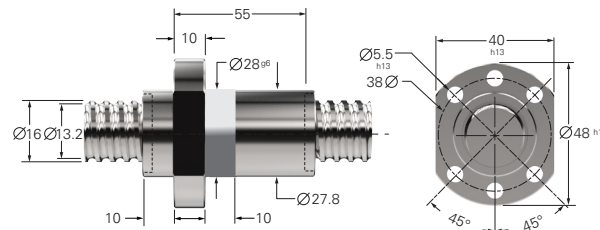

NEMA 34 Ball Screw End Machining NEMA 34 Encoder

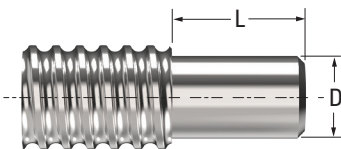

Motor Size	Thread (Dia. x Lead)	End Code	Diameter "D" (mm)	Length "L" (mm)
NEMA 34	16 x 2	8N	12	8
	16 x 5	8N	12	8
	16 x 10	8N	12	8
	16 x 16	8N	12	8
	16 x 50	8N	12	8

Custom end-machining options available upon request. Contact us today for details.

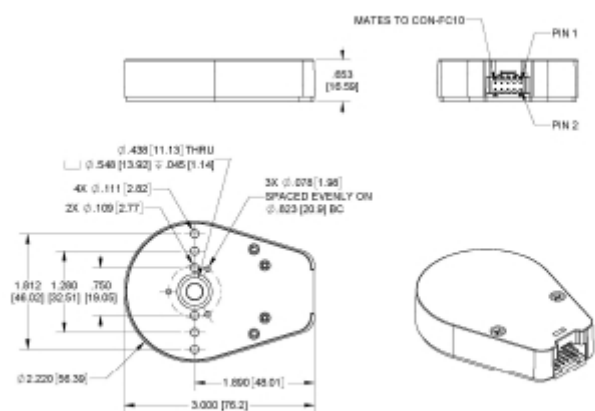

Helix Ball Screw Availability Tables

BALL SCREWS			NEMA 8	NEMA 11		NEMA 14		NEMA 17		NEMA 23		NEMA 34
			2.5 VDC 5.0 VDC 7.5 VDC	2.1 VDC 5.0 VDC 12.0 VDC	2.1 VDC 5.0 VDC 12.0 VDC	2.33 VDC 5.0 VDC 12.0 VDC	2.33 VDC 5.0 VDC 12.0 VDC	2.33 VDC 5.0 VDC 12.0 VDC	2.33 VDC 5.0 VDC 12.0 VDC	3.25 VDC 5.0 VDC 12.0 VDC	3.25 VDC 5.0 VDC 12.0 VDC	2.85 VDC 5.47 VDC 12.0 VDC
Nominal Dia. (mm)	Lead (mm)	Ball Screw Code	Single Stack	Single Stack	Double Stack	Single Stack	Double Stack	Single Stack	Double Stack	Single Stack	Double Stack	Single Stack
4	1	B04010	√	-	-	-	-	-	-	-	-	-
5	2	B05020	√	√	√	-	-	-	-	-	-	-
5	3	B05030	√	√	√	-	-	-	-	-	-	-
6	1	B06010	-	√	√	-	-	-	-	-	-	-
6	2	B06020	-	√	√	-	-	-	-	-	-	-
6	6	B06060	-	√	√	-	-	-	-	-	-	-
8	1	B08010	-	-	-	√	√	√	√	-	-	-
8	2	B08020	-	-	-	√	√	√	√	-	-	-
8	5	B08050	-	-	-	√	√	√	√	-	-	-
8	8	B08080	-	-	-	√	√	√	√	-	-	-
8	12	B08120	-	-	-	√	√	√	√	-	-	-
10	2	B10020	-	-	-	-	-	-	-	√	√	-
10	3	B10030	-	-	-	-	-	-	-	√	√	-
10	4	B10040	-	-	-	-	-	-	-	√	√	-
10	10	B10100	-	-	-	-	-	-	-	√	√	-
12	2	B12020	-	-	-	-	-	-	-	√	√	-
12	4	B12040	-	-	-	-	-	-	-	√	√	-
16	2	B16020	-	-	-	-	-	-	-	-	-	√
16	5	B16050	-	-	-	-	-	-	-	-	-	√
16	10	B16100	-	-	-	-	-	-	-	-	-	√
16	16	B16160	-	-	-	-	-	-	-	-	-	√
16	50	B16500	-	-	-	-	-	-	-	-	-	√

Force vs. Speed Graphs

Ball Screw Stepper Motor Actuators - Single Stack

NEMA 8 - 20 MM

24VDC, Rated Current, Bipolar Drive

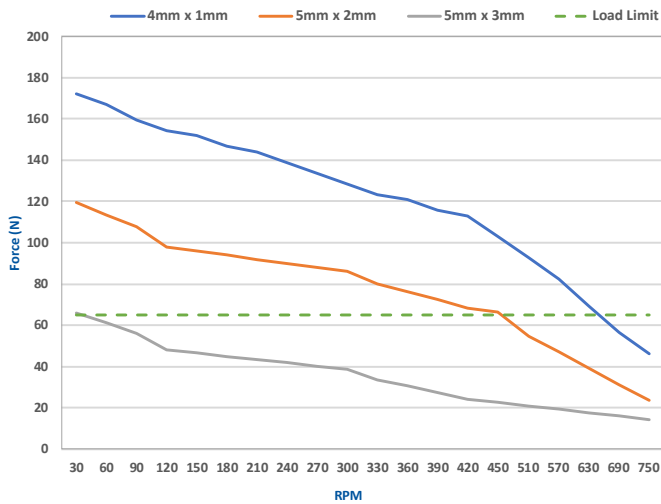

NEMA 11 - 28 MM

24VDC, Rated Current, Bipolar Drive

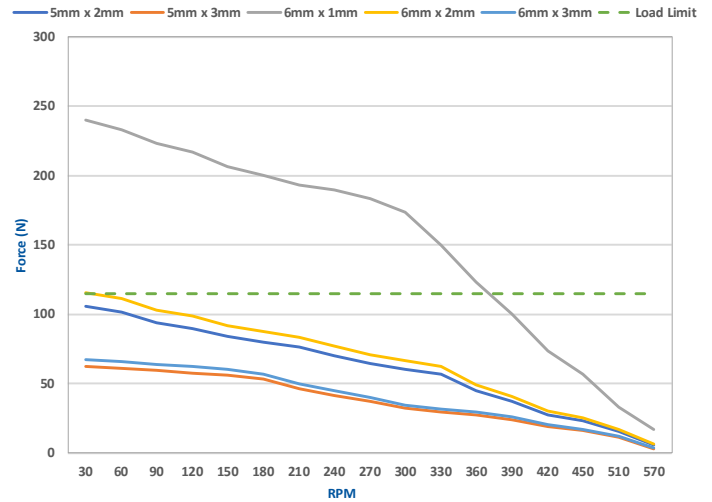

NEMA 14 - 35 MM

24VDC, Rated Current, Bipolar Drive

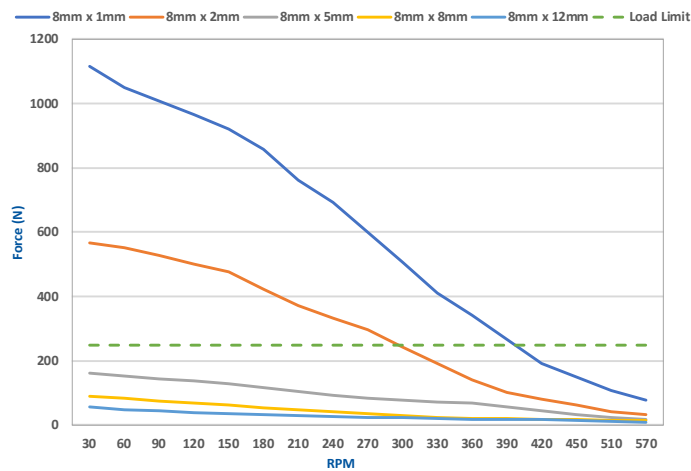

NEMA 17 - 42 MM

24VDC, Rated Current, Bipolar Drive

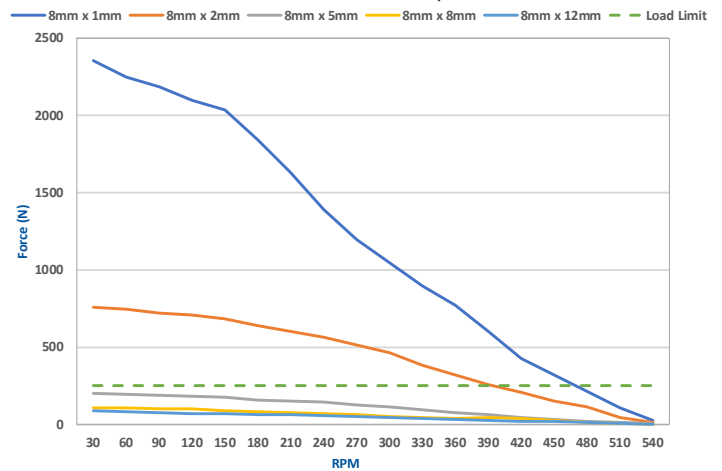

NEMA 23 - 57 MM

24VDC, Rated Current, Bipolar Drive

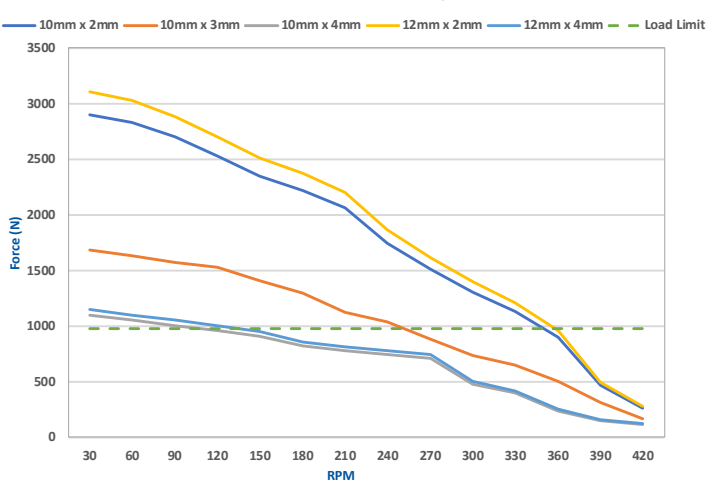

NEMA 34 - 86 MM

24VDC, Rated Current, Bipolar Drive

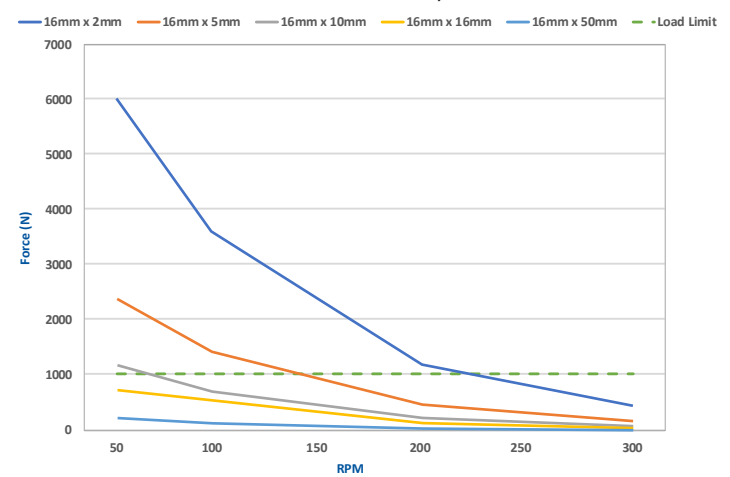

Force vs. Speed Graphs

Ball Screw Stepper Motor Actuators - Double Stack

NEMA 11 - 28 MM

24VDC, Rated Current, Bipolar Drive

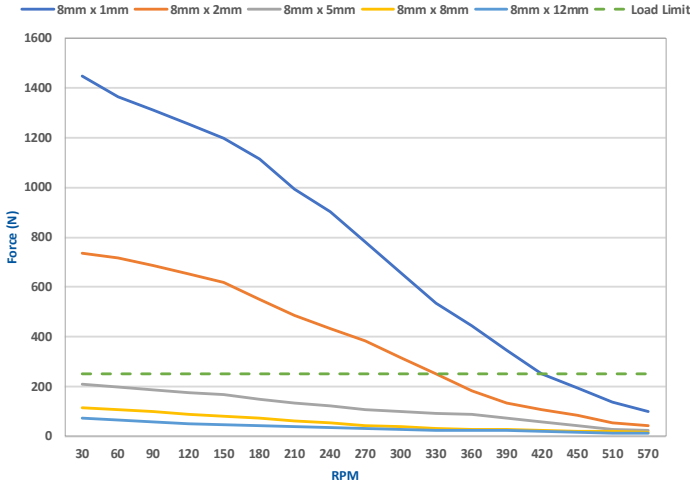

NEMA 14 - 35 MM

24VDC, Rated Current, Bipolar Drive

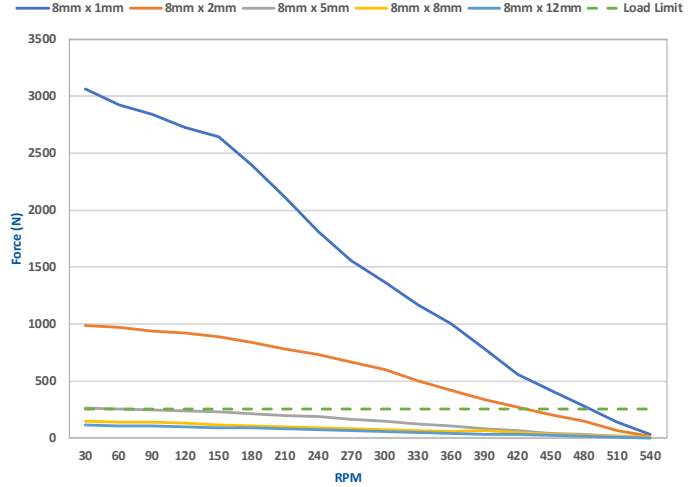

NEMA 17 - 42 MM

24VDC, Rated Current, Bipolar Drive

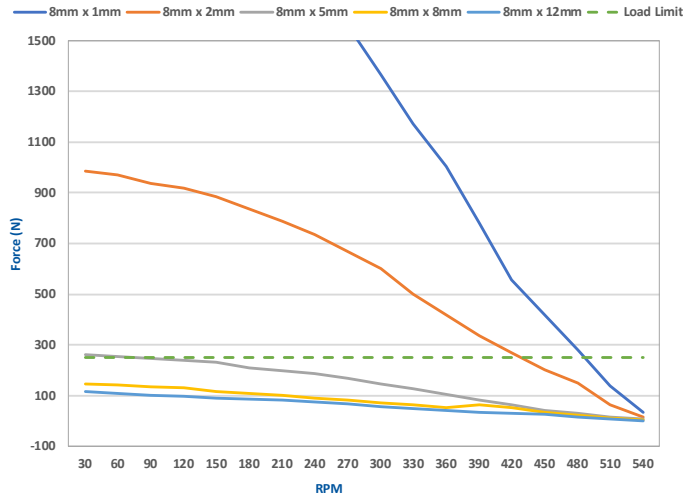

NEMA 23 - 57 MM

24VDC, Rated Current, Bipolar Drive

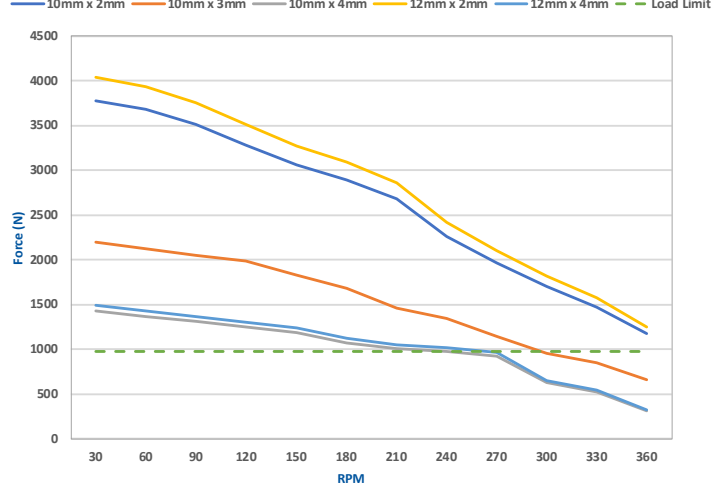

LINEAR MOTION APPLICATIONS

High Quality, Precision Linear Motion Solutions

LIFE SCIENCES



- Auto samplers
- Syringe pumps
- Microscopes
- MRI scanners
- CT scanners
- Radiographic machines
- In-vitro diagnostics
- Genomics
- Blood gas chemistry

PRINTING & BINDING

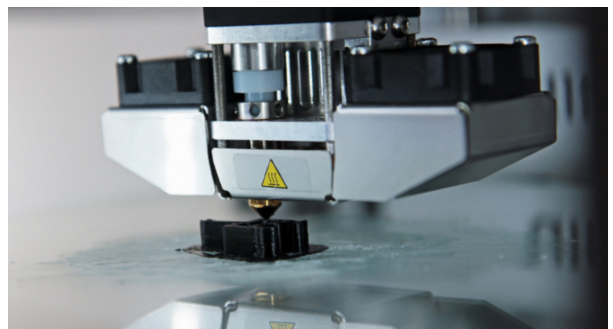

- "Z" axis actuators
- Multi-axis gantries
- 3D printing
- Automation / Material handling
- Additive manufacturing (AD)
- Large format sign printing
- Digital offset printing process
- Folding and sealing equipment
- Thermal CTP systems

SECURITY - MILITARY



- Automated door locking systems
- Pan-tilt-zoom cameras
- Automated gates
- Tactical automated security cameras
- Missile fin actuation
- Tank sighting systems
- Drones and UAVs
- Torpedo fin actuation
- Guided munitions

SEMICONDUCTOR



- Burnishing stages
- Stacking systems
- Vision inspection machines
- X, Y, Z gantries
- Wafer elevators / Wafer handling
- Acoustic microscopes
- Ultrasonic imaging
- Tuning coils
- Vacuum chamber doors