

Precision Rolled Ball Screws

Double Circuit Ball Nut (Alloy Steel)



.500" diameter x .200" lead

Ball Nut Part Number: **HBN5002**

Helix: **RH**

Dynamic Load: **974 lb**

Static Load: **7,073 lb**

Balls per Circuit/Nut: **40/80**

Nominal Ball Diameter: **.125"**

Torque to Raise 1 lb: **0.035 in/lb**

Nut Weight: **0.5 lb**

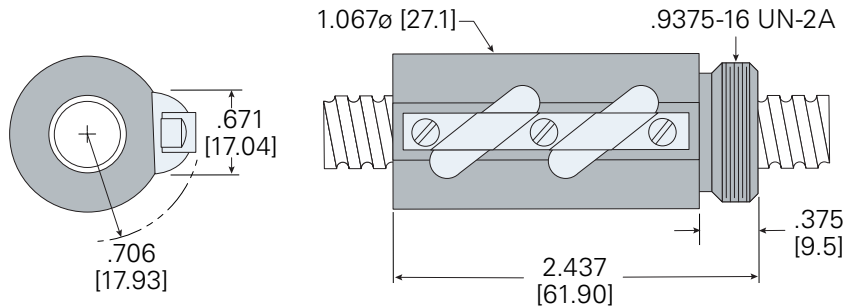

Ball Screw	
<i>single start</i>	
Ball Screw Part Number:	0016
Ball Circle Diameter:	.500"
Lead:	.200"
Root Diameter:	.404"
Screw Weight:	0.49 (lb/ft)

Standard Screw Lengths	
<i>Custom cut lengths available up to 12'</i>	
Length	Part Number
2'	CLB5024
4'	CLB5048
6'	CLB5072

Flange

RFL5000 (alloy)

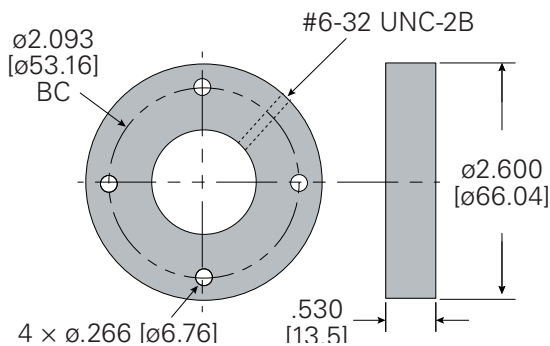

Contact a Helix sales engineer:

sales@helixlinear.com

216-485-2232

helixlinear.com