

Precision Rolled Ball Screws

Double Circuit Ball Nut (Alloy Steel)



.750" diameter x .200" lead

- Ball Nut Part Number: **HBN7501**
- Helix: **RH**
- Dynamic Load: **2,205 lb**
- Static Load: **17,140 lb**
- Balls per Circuit/Nut: **70/140**
- Nominal Ball Diameter: **.141"**
- Torque to Raise 1 lb: **0.035 in/lb**
- Nut Weight: **0.79 lb**

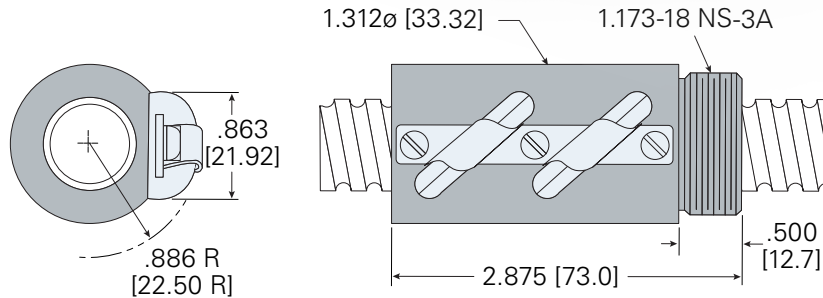

Ball Screw	
<i>single start</i>	
Ball Screw Part Number:	0017
Ball Circle Diameter:	.750"
Lead:	.200"
Root Diameter:	.602"
Screw Weight:	1.20 (lb/ft)

Standard Screw Lengths			
<i>Custom cut lengths available up to 12'</i>			
Length	Part Number	Length	Part Number
2'	CLB7524	8'	CLB7596
4'	CLB7548	12'	CLB75144
6'	CLB7572		

Flange

RFL7500 (alloy)

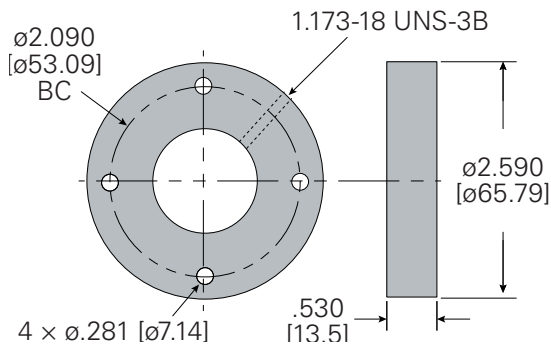

Wiper Kit

(two wipers, one retainer)
BWS750

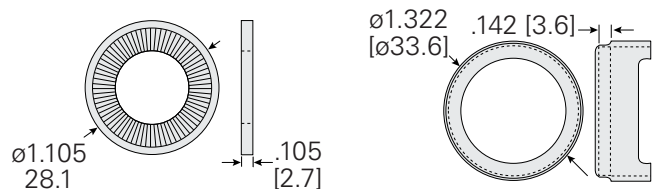

Contact a Helix sales engineer:
sales@helixlinear.com
216-485-2232