

Precision Rolled Ball Screws

Double Circuit Ball Nut (Alloy Steel)



.750" diameter x .500" lead

Ball Nut Part Number: **HBN7552**
 Helix: **RH**
 Dynamic Load: **2,726lb**
 Static Load: **17,430 lb**
 Balls per Circuit/Nut: **78/156**
 Nominal Ball Diameter: **.141"**
 Torque to Raise 1 lb: **0.088 in/lb**
 Nut Weight: **0.79 lb**

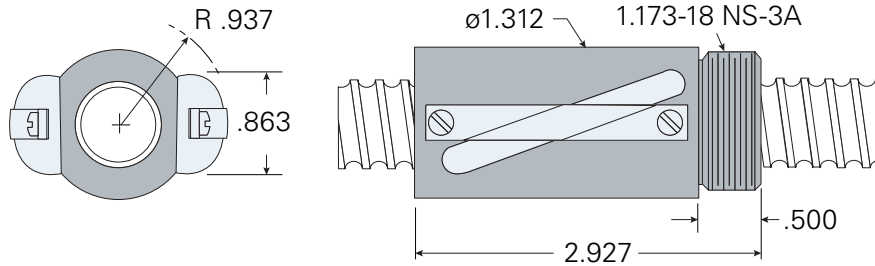

Ball Screw	
<i>single start</i>	
Ball Screw Part Number:	0017
Ball Circle Diameter:	.750"
Lead:	.500"
Root Diameter:	.602"
Screw Weight:	1.20 (lb/ft)

Standard Screw Lengths			
<i>Custom cut lengths available up to 12'</i>			
Length	Part Number	Length	Part Number
2'	CLB7624	8'	CLB7696
4'	CLB7648	12'	CLB76144
6'	CLB7672		

Flange

RFL7500 (alloy)

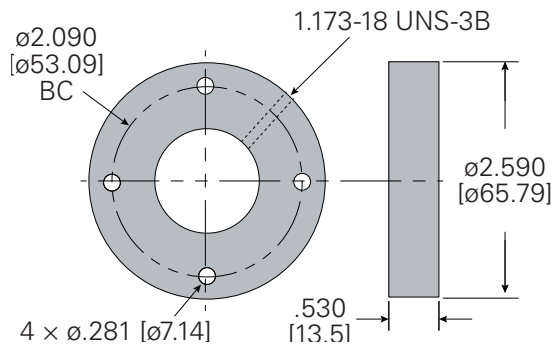

Wiper Kit

(two wipers, one retainer)
BWS750

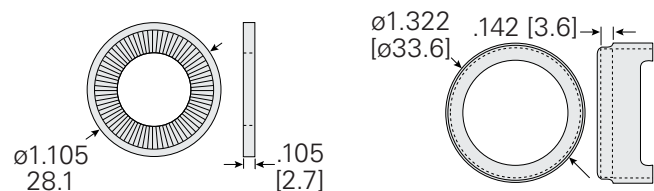

Contact a Helix sales engineer:

sales@helixlinear.com
 216-485-2232

helixlinear.com