

Precision Rolled Ball Screws





Associations

ASSOCIATION FOR
HIGH TECHNOLOGY
DISTRIBUTION **AHTD**

EPTDA
Member

PTDA
Member



Certifications

ISO ISO 9001 : 2008
CERTIFIED

ITAR International Traffic in Arms
Regulations Compliant





Helix Linear Technologies, Inc., Beachwood, Ohio USA

Company

Helix Linear Technologies is a global manufacturer of linear actuators, lead screws and ball screws. Serving clients in the aerospace, medical, life science, security, semiconductor, and defense industries, we focus on helping our customers achieve their application and profitability goals. Our innovative product design and world-class engineering capabilities solve real-world linear motion issues, building a foundation for our client's long-term success.

Culture

Our culture is rooted in agility, responsiveness, and teamwork. Our team is comprised of happy, competitive professionals who excel in manufacturing innovative electromechanical linear motion solutions. We strive to exceed our customers' expectations in all interactions and are committed to continuous improvement.

History

Helix Linear Technologies was founded in 2011 to meet the growing demand for high-precision lead screws in the electromechanical actuation industry. Our rapid growth and expanded product lines now include end-to-end linear actuator solutions, providing our clients with customized options and fully integrated solutions.

Contents

Ball Screw Assemblies

Glossary and Definitions	4
End Fixity	9
Critical Speed	10
Column Load Strength	11
Glossary and Definitions	12
Design Considerations	14
Part Number Configuration	15

Technical Information

.375 diameter × .125 lead	16
.500 diameter × .200 lead	18
.500 diameter × .500 lead	20
.631 diameter × .200 lead	22
.631 diameter × .500 lead	24
.750 diameter × .200 lead	26
.750 diameter × .500 lead	28
.875 diameter × .200 lead	30
1.000 diameter × .250 lead	32
1.000 diameter × .500 lead	34
1.000 diameter × 1.000 lead ..	36

Bearing Support

Introduction	38
Quick Reference Guide	40
Bearing Support Options	
• Universal Double	42
• Universal Single	44
• Flanged Double	46
• Flanged Single	48
• Universal Motor Mount	50
• Flanged Motor Mount	52
• End Machining	54

Glossary and Definitions

Major Diameter of the screw is the largest diameter measured from the crest of one thread to the crest on the opposite side.

Minor Diameter is the smallest diameter of the screw thread, measured from the root of one thread to the root on the opposite side.

Ball Circle Diameter is a theoretical cylinder that passes through the center of the balls in a ball screw assembly.

Figure 1

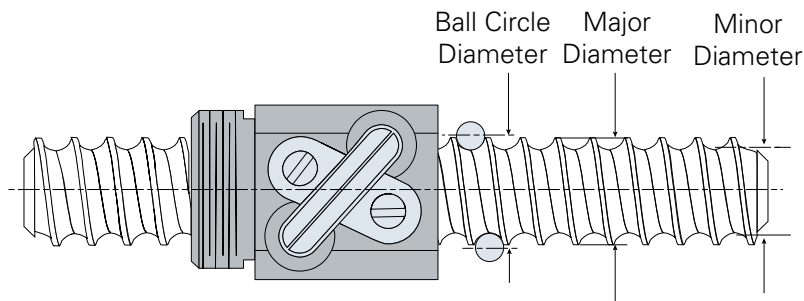

Lead of a ball screw is the distance the nut travels along the screw axis per one revolution of the screw. We offer various lead options to balance speed and precision. The formula for lead is

$$\text{Lead} = \text{Pitch} \times \text{Number of Starts}$$

Pitch is the distance between corresponding points on adjacent threads of a screw. It is a fundamental parameter that influences the screw's lead and overall performance. The formula for pitch is

$$\text{Pitch} = \text{Lead} / \text{Number of Starts}$$

Screw Starts refer to the number of threads that begin simultaneously on a screw. A single-start screw has one continuous thread, while a multi-start screw has multiple threads. Multi-start screws provide faster linear travel per rotation, making them suitable for high-speed applications. Helix Linear manufactures both single-start and multi-start screws to meet diverse application requirements

Figure 2

Single Start
(lead = pitch)

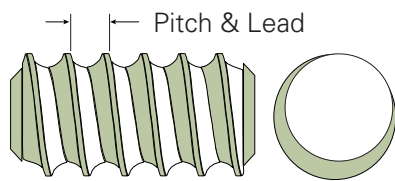

Double Start
(lead = 2 x pitch)

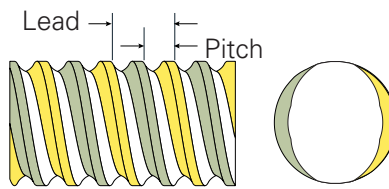

Four Start
(lead = 4 x pitch)

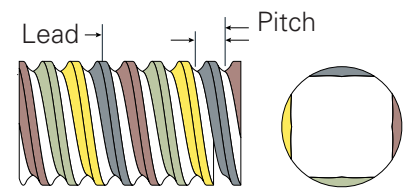

Helix ball screws are used in satellites.

Glossary and Definitions

Matched Leads refer to ball screws that are paired to have consistent leads. This is essential for applications that require synchronized motion or load sharing.

Backlash is the lost motion in a screw system due to clearance between the screw and nut. It is an undesirable characteristic, especially in precision applications, as it leads to positioning errors. Backlash can be minimized by preloading the ball screw or using anti-backlash nuts.

Selective Fitting involves choosing components that fit together with desired tolerances. This process ensures optimal performance by matching parts that complement each other's dimensions. In ball screws, selective fitting helps achieve minimal backlash.

Preloading is the application of an initial load to remove backlash in a ball screw system. This load can be applied mechanically or through differential lead of the screw and nut. Preloading enhances the rigidity and positional accuracy of the ball screw.

Lead accuracy refers to the deviation between the actual lead and the theoretical lead of a ball screw. It is a critical factor for applications requiring high precision. Lead accuracy is typically specified in micrometers per 300 mm or inches per foot. Helix Linear Technologies provides ball screws with C7, C5, C3 and C0 lead accuracy tolerances to meet stringent performance standards.

Efficiency in ball screws is the ratio of output power to input power. It indicates how effectively the screw converts rotational motion into linear motion. The formula for efficiency is

$$\text{Efficiency} = (\text{Output Power} / \text{Input Power}) \times 100\%$$

Helix Linear ball screws are designed to have an operating efficiency of greater than 90%.

Adjustable Preload for ball screws can be configured to fall between 10% (recommended) and 30% (maximum) of the dynamic load rating. Operating within this specified range ensures that the assemblies maintain their load-bearing capacity and lifespan with minimal degradation.

To illustrate the impact of preload magnitude and direction on preloaded units, consider the three examples provided below. These examples are critical for determining the appropriate preload size and force. The direction of the applied load influences both the stiffness of the ball screw and the potential for backlash, factors that are crucial for optimal performance in precision applications.

Tension load is a force that attempts to elongate the screw. Ball screws subjected to tension loads must have sufficient tensile strength to prevent failure. The tensile strength of the material and the minor diameter of the screw are key factors in withstanding tension loads.

Compression load is a force that attempts to shorten the screw. Ball screws under compression must resist buckling and maintain structural integrity. The critical load for buckling depends on the screw's length, diameter, and end fixity conditions.

Figure 3

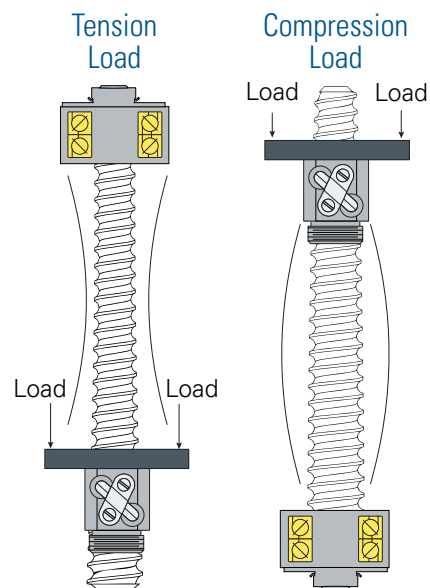

Axial load is a force applied along the axis of the screw. It is the primary load type for which ball screws are designed. Axial loads can be either tensile or compressive, depending on the application. Properly accounting for axial loads ensures the ball screw operates within its design limits and maintains longevity.

Overturning Loading is a load that causes bending in the screw. This type of load can result from misalignment, uneven load distribution, or external forces. Moment loading must be minimized to prevent excessive stress and potential failure. Proper alignment, support, and load distribution are crucial for reducing moment loads in ball screw systems.

Side loading is a load applied perpendicular to the screw axis. It can cause bending and uneven wear in the ball screw. Ball screws are generally not designed to handle significant side loads. To minimize side loading, proper alignment and support of the screw and nut are essential.

Ball Screw Life refers to the expected operational lifespan of a ball screw. It depends on factors such as load, speed, lubrication, and operating environment. Manufacturers provide life expectancy based on standard usage conditions. Regular maintenance and proper usage can extend the ball screw's life beyond its rated expectancy.

$$T_x = \left(\frac{F_r}{F_x} \right) \times T_r$$

Where:

- T_x = Travel other than rated load
- F_r = Rated load
- F_x = Actual load
- T_r = Rated travel life

Figure 4

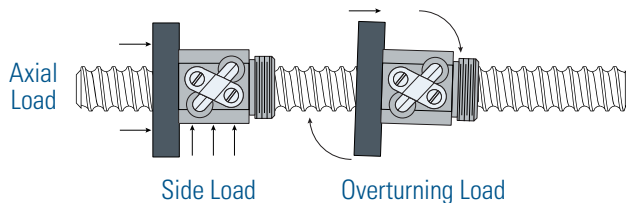

Applied Dynamic Loading is the load applied to the ball screw while it is in motion. It is a critical factor for determining the ball screw's dynamic load rating. Dynamic loading conditions include variations in speed, acceleration, and direction. Properly analyzing dynamic loads ensures the ball screw can handle the expected operational conditions without failure.

Design Life Objective is the intended lifespan of the ball screw in its application. It is based on factors such as load, speed, operating conditions, and maintenance. Manufacturers design ball screws to meet specific life objectives, ensuring they perform reliably throughout their intended use. Properly defining the design life objective helps in selecting the right ball screw for the application.

Equivalent Loading is a simplified representation of varying loads over time. It combines different load magnitudes and durations into a single, constant load value. The equivalent load is used to estimate the ball screw's fatigue life and performance. Calculating equivalent loading involves considering the load spectrum and applying appropriate weighting factors.

$$L_m = \sqrt[3]{\frac{\%_1(L_1)^3 + \%_2(L_2)^3 + \%_3(L_3)^3 + \dots + \%_n(L_n)^3}{100}}$$

Where:

- L_m = equivalent load
- L_n = each increment of load
- $\%_n$ = percent of stroke at load L_n

End Fixity

End fixity describes the type of support provided at the ends of the ball screw. Common types include fixed, floating, and supported ends. End fixity affects the screw's critical speed, buckling resistance, and overall stability. Properly selecting and implementing end fixity is crucial for ensuring reliable ball screw operation.

Figure 5

Free

No support

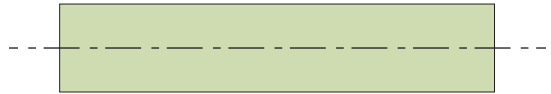

Simple

Restrained against radial and/or axial loads

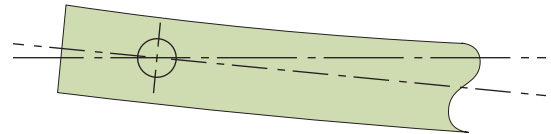

Fixed

Shaft rigidly restrained against radial, axial and moment loads

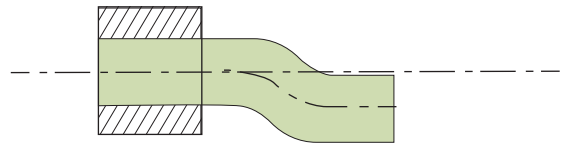
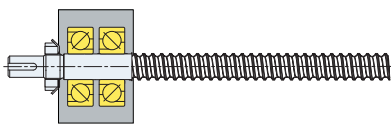

Figure 6

BEARING MOUNT CONFIGURATIONS

Fixed/Free (A)



fixed

free

Simple/Simple (B)



simple

simple

Fixed/Simple (C)



fixed

simple

Fixed/Fixed (D)

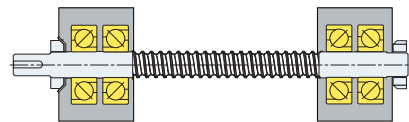

fixed

fixed

Glossary and Definitions

Drive Torque is the torque required to rotate the screw and move the load. It depends on factors such as the lead, friction, and load on the ball screw. Calculating the drive torque is essential for selecting the appropriate motor and ensuring efficient operation. Helix Linear Technologies provides ball screws designed to minimize drive torque requirements.

Back-drive torque is the torque required to rotate the screw in the opposite direction of the load. This characteristic is important for applications where back-driving needs to be controlled or prevented. Properly designed ball screws can minimize back-drive torque to enhance system stability.

Ball Screw Finish: Our ball screws are polished with a super finishing process after hardening. The polishing process improves the surface finish of the ball groove and extends life. For applications that involve harsh environmental conditions, additional protective coatings like nickel, hard chrome, or zinc may be applied. For detailed specifications on these coatings and their application, please contact Helix Linear Technologies.

Materials and Hardness: Our standard imperial ball screws and ball nuts are manufactured from alloy steel and case-hardened to a minimum hardness of Rc 56. For our standard imperial stainless steel ball screws, we use 17-4 PH precipitation hardenable stainless steel, hardened to at least Rc 38. If specialty materials are required, please contact the factory for further details.

Screw Straightness: Maintaining screw straightness is crucial for minimizing vibration. Our ball screw material is straight to within 0.010 inches per foot, and will not exceed 0.025 inches over the entire length. For machined screws, we can achieve straightness tolerances as tight as 0.002 inches per foot, depending on the screw's diameter and length.

Temperature Range: Our ball screws are designed to operate within a temperature range of -65°F (-54°C) to 300°F (149°C), provided that proper lubricants are used.



Ball screws are used in infusion pumps.

Critical Speed

Critical speed is the speed at which the screw may start to vibrate dangerously. It depends on factors such as length, diameter, and end support conditions. Operating a ball screw above its critical speed can lead to resonance, causing excessive vibration and potential failure. It is essential to calculate and consider the critical speed to ensure safe and reliable operation.

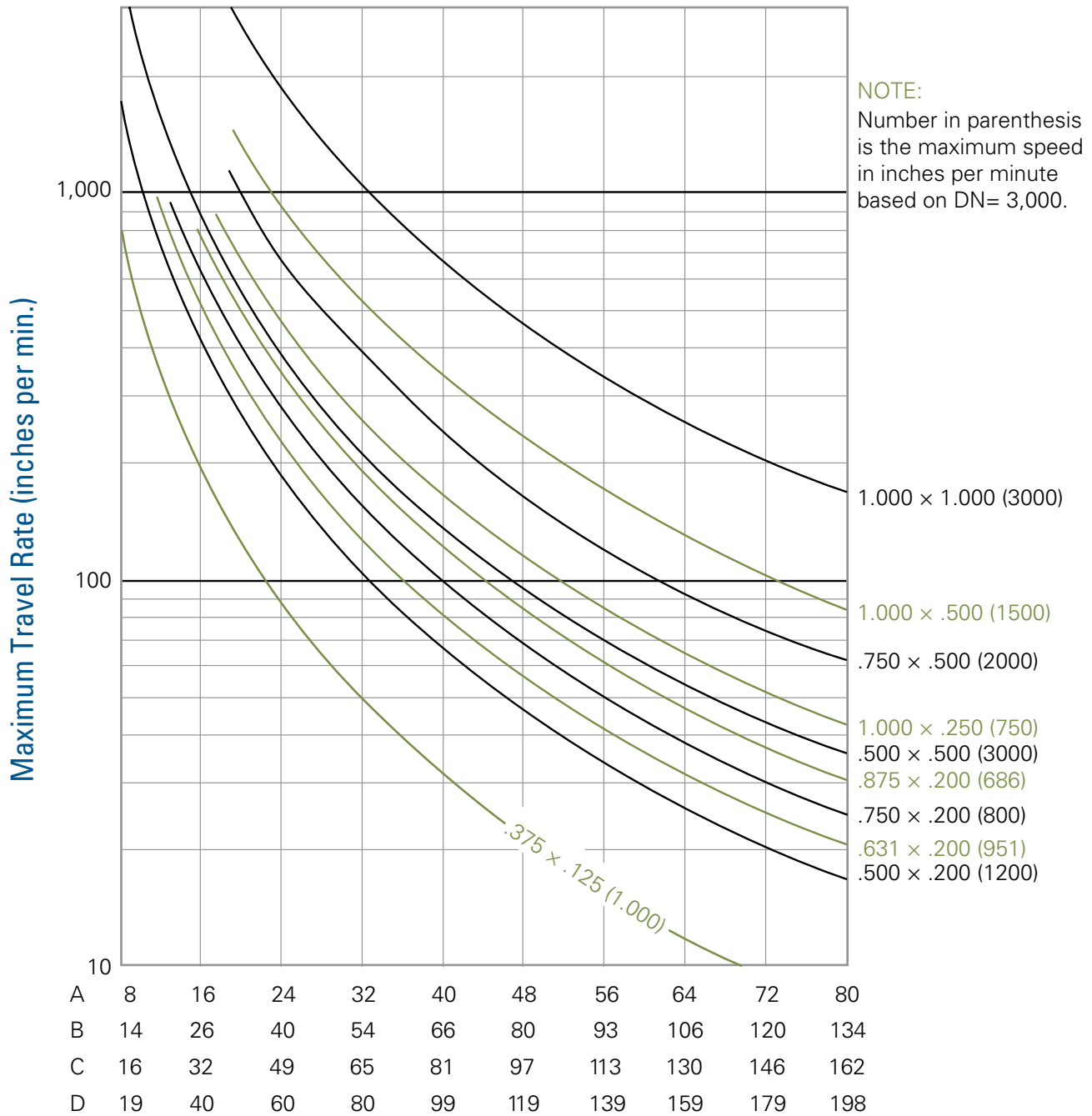

Maximum Length Between Bearings (in)
see page 8 for descriptions of ABCD end fixity

Column Load Strength

Column load strength refers to the ability of the ball screw to withstand compressive forces without buckling. This is determined by the screw's material, length, diameter, and end fixity. Proper design and selection of ball screws ensure they can handle the expected column loads. Exceeding the column load strength can result in deformation and failure of the ball screw.

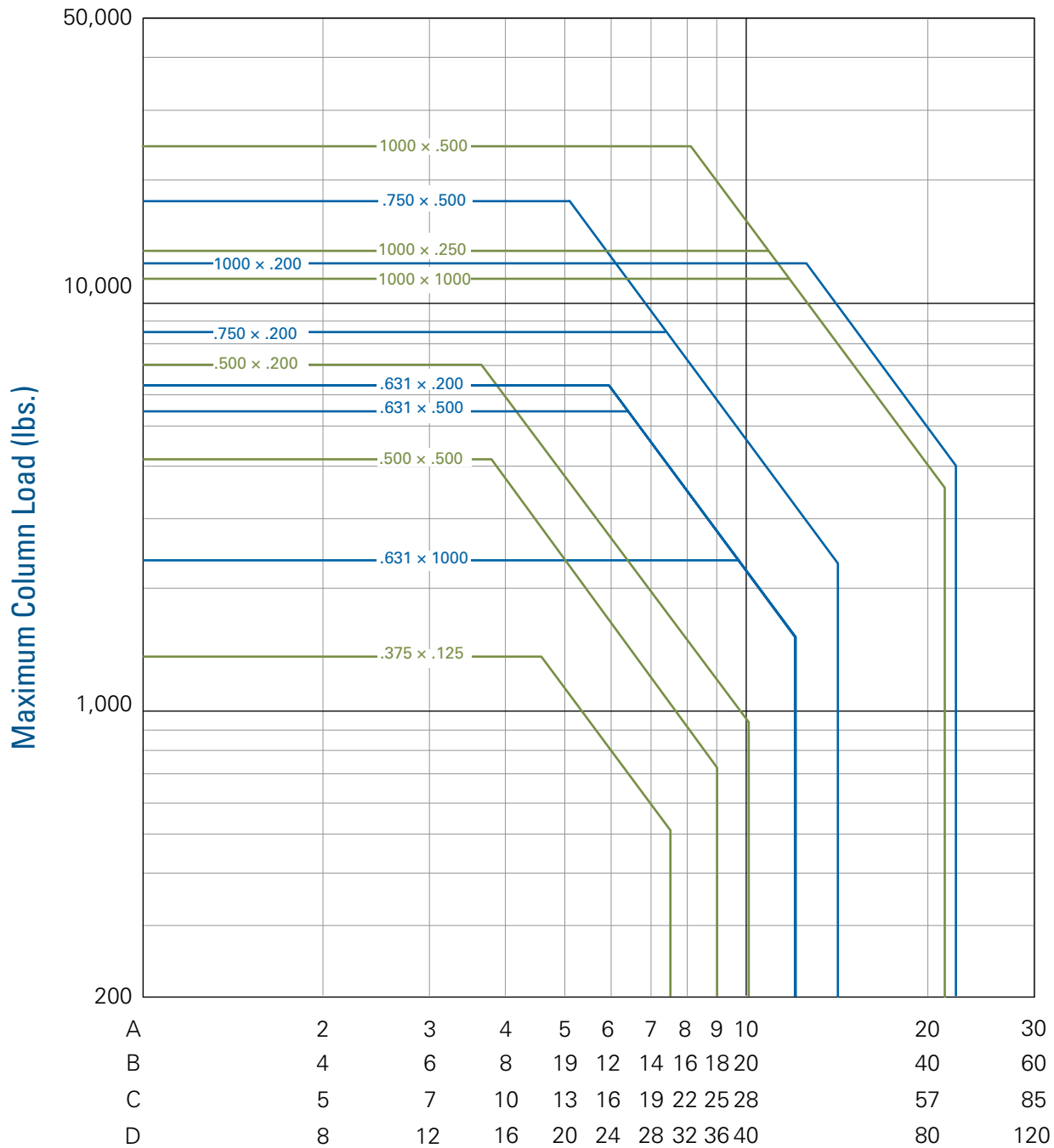

Maximum Length (in.)

see page 9 for descriptions of ABCD end fixity

Accessories

Wiper Kits are compatible with most standard ball screw models. These kits feature nylon brush wipers designed to prevent large particulates from contaminating the ball nut.

For environments with extreme conditions, it is advisable to use boots or bellows to fully enclose the screw. Custom wipers and ice-breakers can be provided. Contact sales@helixlinear.com.

Figure 7

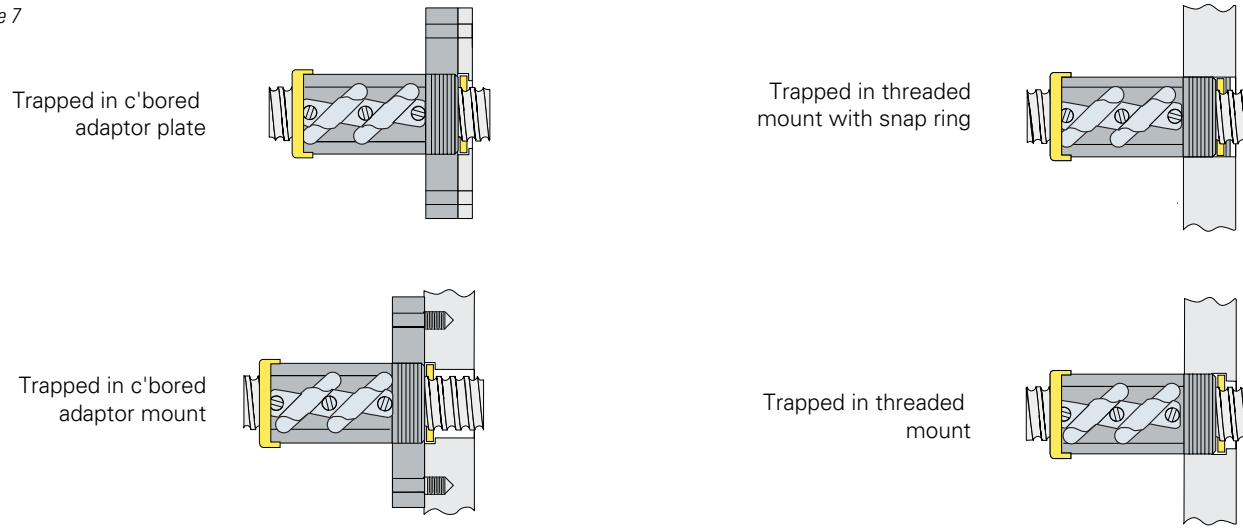

Mounting Flanges: When utilizing a mounting flange instead of the standard V-thread on the ball nut body, it is essential to ensure the flange is permanently secured to prevent it from disengaging during operation. The two primary methods for securing the flange are pinning and using a set screw. For light load applications, commercial thread locking adhesives may also be used. It is recommended that flange pinning be performed at the factory to ensure no metal chips remain after drilling.

Figure 8

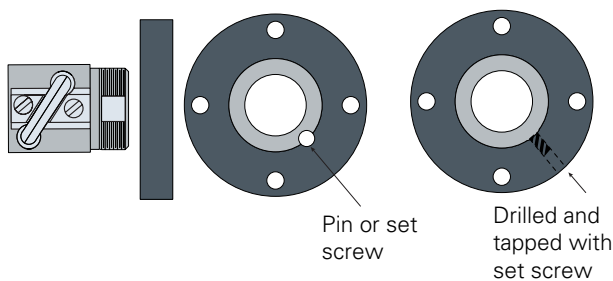

Flange Orientation: The position of the flange bolt holes relative to the return tube components depends on the number of holes in the flange. Unless specified otherwise, the illustrations provided below show the standard orientations.

Figure 9

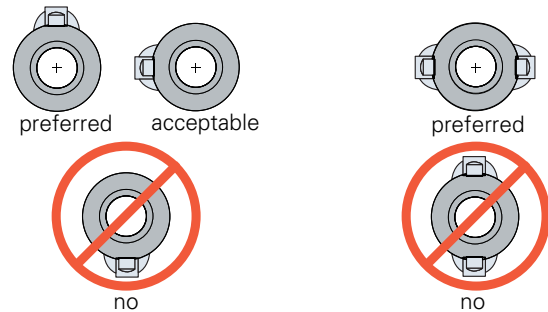

Lubrication: Proper lubrication is essential for maintaining efficiency and extending the life of the ball screw. Various lubrication methods, such as grease or oil, can be used depending on the application. Failure to lubricate ball screws will reduce the expected life by 90%



Ball screws are used in the food and beverage industry.

Design Considerations

Transferring Ball Nuts from Shipping Arbor

Ball nuts are typically shipped on arbors. To transfer the ball nut to the ball screw, align the arbor with the end of the screw thread and carefully rotate the ball nut onto the screw. If the arbor's inside diameter is too

small for the journal, use tape to match the journal's diameter to the screw's root diameter to prevent the bearing balls from falling out.

Figure 10

- 1 Remove cable tie from arbor.

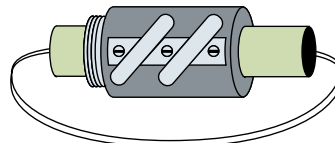

- 2 Slide ball nut off of shipping arbor and onto ball screw.

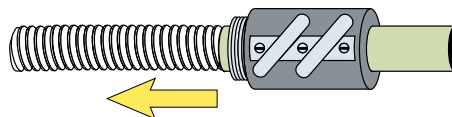

- 3 Rotate ball nut until balls engage with screw thread.

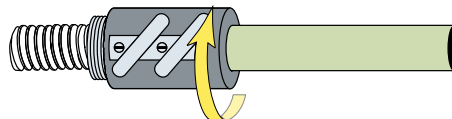

- 4 Keep shipping arbor to facilitate maintenance.

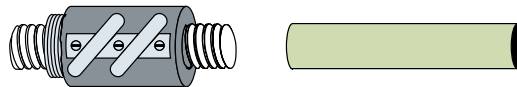

CAUTION: Removing the arbor without proper support will result in the loss of bearing balls, which must be replaced as a set. For additional methods, please visit helixlinear.com.

End Machining

For optimal performance of your ball screw assembly, it is highly recommended that the end machining be performed at the Helix Linear Technologies facility. Ball screws can be supplied machined to your precise specifications or according to standard end machining designs as detailed in our technical documentation.

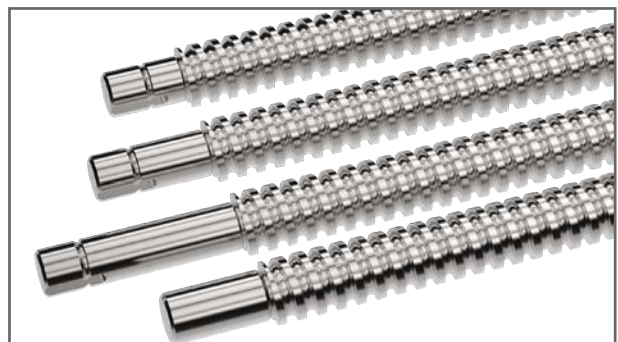

Machined ends of rolled-thread ball screws.

Ball Screw and Nut Assemblies

Part Number Configuration

HBA - 0007 - R - A - HBN6311 - 10.00 - 3K - A1 - T7 - S - A

BALL SCREW CODE

Ball Screw Size	Ball Screw Code	Ball Screw Size	Ball Screw Code
.375 × .125	0012	.750 × .500	0015
.500 × .200	0016	.875 × .200	0008
.500 × .500	0025	1.000 × .250	0022
.631 × .200	0007	1.000 × .500	0023
.631 × .500	0017	1.000 × 1.000	0024
.750 × .200	0014		

THREAD DIRECTION

- R = Right Hand
- L = Left Hand

MATERIAL

- A = Alloy Steel
- S = Stainless Steel

BALL NUT PART NUMBER

OVERALL LENGTH (inches)

0000 = No Nut

LEFT END: EZZE MOUNT OR END MACHINING SHAFT EXTENSION

RIGHT END: EZZE MOUNT OR END MACHINING SHAFT EXTENSION

LEAD ACCURACY TOLERANCE GRADE

- S = ~.0003 in/in
- P = ~.0001 in/in

BACKLASH

- S = Standard <.004"
- R = Reduced Lash

ASSEMBLY

- A = Nut assembled on screw, mounting thread facing left end
- B = Nut assembled on screw, mounting thread facing right end
- U = Nut shipped unassembled from screw on arbor

See tables below

- Single bearing supports are used with Type 1N end machining.
- Double bearing supports are used with Type 3K, 3L, or 3N end machining.
- For annealed ends, specify length of annealed end in increments of 1.00"

END MACHINING (see pages 50-51)

1	Type 1	A	Annealed
2	Type 2	XX	Custom
3	Type 3	00	No End Machining
4	Type 4		

SHAFT EXTENSION (see pages 50-51)

K	Keyway
L	No Keyway
N	No Shaft

EZZE-MOUNT

	Double Bearing Support		Single Bearing Support		Motor Mount
	cover plate facing thread	cover plate away from thread	locating boss facing thread	locating boss away from thread	
Universal				n/a	
Flanged					

.375 diameter × .125 lead

Single Circuit Ball Nut

Ball Nut Part Number	Material	Helix	Dynamic Load (lb)	Static Load (lb)	Balls per Circuit/Nut	Nominal Ball Diameter (in)	Nut Weight (lb)	Torque to Raise 1 lb (in/lb)
HBN3751	Alloy	RH	137	136	60/60	.063	0.12	0.022
HBN3753	Stainless	RH	25	25	60/60	.063	0.12	0.022

Double Circuit Ball Nut

Ball Nut Part Number	Material	Helix	Dynamic Load (lb)	Static Load (lb)	Balls per Circuit/Nut	Nominal Ball Diameter (in)	Nut Weight (lb)	Torque to Raise 1 lb (in/lb)
HBN3752	Alloy	RH	273	2,830	60/120	.063	0.21	0.022
HBN3754	Stainless	RH	51	510	60/120	.063	0.21	0.022

Double Circuit Ball Nut with Adjustable Preload

Ball Nut Part Number	Material	Helix	Dynamic Load (lb)	Static Load (lb)	Balls per Circuit/Nut	Nominal Ball Diameter (in)	Nut Weight (lb)	Torque to Raise 1 lb (in/lb)
HBN3755	Alloy	RH	136	1,415	60/120	.063	0.21	0.022

Ball Screw

single start

Ball Circle Diameter (in)	Lead (in)	Root Diameter (in)	Screw Weight (lb/ft)
.375	.125	.300	.5

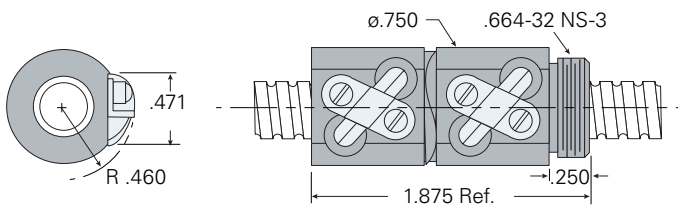
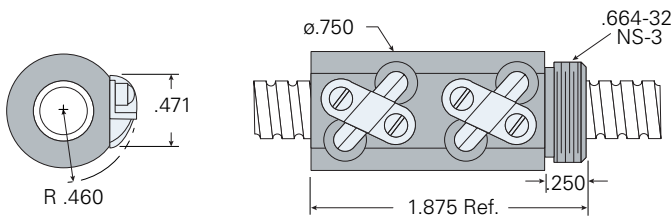
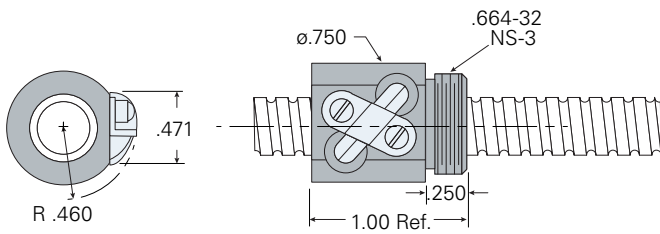

Flange

RFL3750 (alloy)

RFL3750SS (stainless)

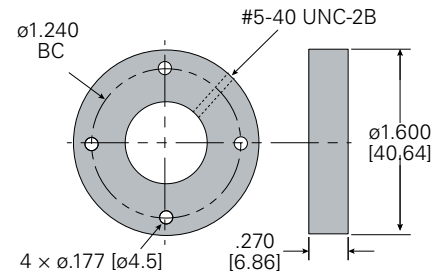

Standard Screw Lengths

Custom cut lengths available up to 12'

	Alloy	Stainless
2'	CLB3724	CLB3824
4'	CLB3748	CLB3848
6'	CLB3772	CLB3872

For longer lengths, contact sales@helixlinear.com.

.500 diameter × .200 lead

Double Circuit Ball Nut

Ball Nut Part Number	Material	Helix	Dynamic Load (lb)	Static Load (lb)	Balls per Circuit/Nut	Nominal Ball Diameter (in)	Nut Weight (lb)	Torque to Raise 1 lb (in/lb)
HBN5002	Alloy	RH	974	7,073	40/80	.125	0.5	0.035

Ball Screw

single start

Ball Circle Diameter (in)	Lead (in)	Root Diameter (in)	Screw Weight (lb/ft)
.500	.200	.404	0.49



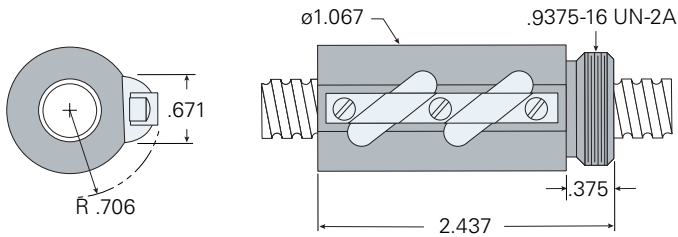

Flange

RFL5000 (alloy)

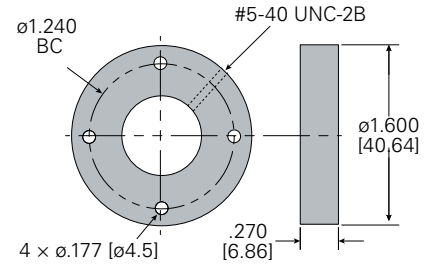

Standard Screw Lengths

Custom cut lengths available up to 12'

	Alloy
2'	CLB5024
4'	CLB5048
6'	CLB5072

For longer lengths, contact sales@helixlinear.com.



Ball screws are used in a wide variety of factory automation projects.

.500 diameter × .500 lead

Double Circuit Ball Nut

Ball Nut Part Number	Material	Helix	Dynamic Load (lb)	Static Load (lb)	Balls per Circuit/Nut	Nominal Ball Diameter (in)	Nut Weight (lb)	Torque to Raise 1 lb (in/lb)
HBN5003	Alloy	RH	786	4,131	30/60	.125	0.27	0.088

Ball Screw

single start

Ball Circle Diameter (in)	Lead (in)	Root Diameter (in)	Screw Weight (lb/ft)
.500	.500	.360	0.500



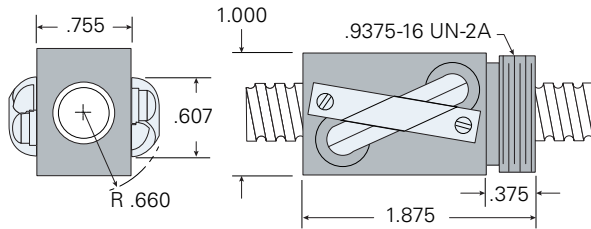

Flange

RFL5000 (alloy)

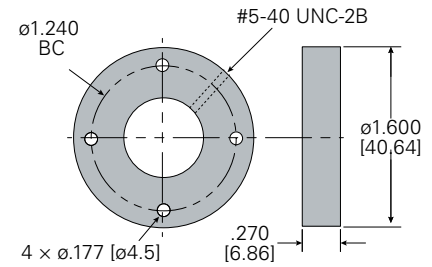

Standard Screw Lengths

Custom cut lengths available up to 12'

	Alloy
2'	CLB5524
4'	CLB5548
6'	CLB5572

For longer lengths, contact sales@helixlinear.com.



Ball screws are used in a wide variety of packaging applications.

.631 diameter × .200 lead

Single Circuit Ball Nut

Ball Nut Part Number	Material	Helix	Dynamic Load (lb)	Static Load (lb)	Balls per Circuit/Nut	Nominal Ball Diameter (in)	Nut Weight (lb)	Torque to Raise 1 lb (in/lb)
HBN6311	Alloy	RH	816	6,388	68/68	.063	.26	0.035
HBN6312	Stainless	RH	141	1,150	68/68	.063	.26	0.035

Double Circuit Ball Nut with Adjustable Preload

Ball Nut Part Number	Material	Helix	Dynamic Load (lb)	Static Load (lb)	Balls per Circuit/Nut	Nominal Ball Diameter (in)	Nut Weight (lb)	Torque to Raise 1 lb (in/lb)
HBN6313	Alloy	RH	743	6,168	68/136	.063	.64	0.035

Ball Screw

single start

Ball Circle Diameter (in)	Lead (in)	Root Diameter (in)	Screw Weight (lb/ft)
.631	.200	.500	.81

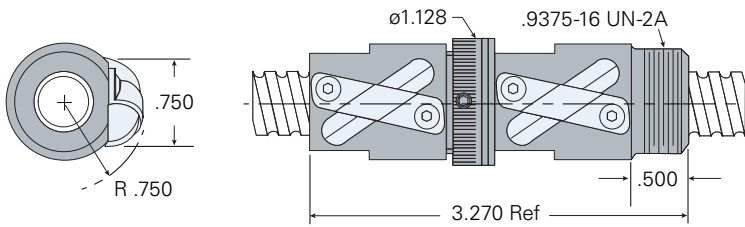
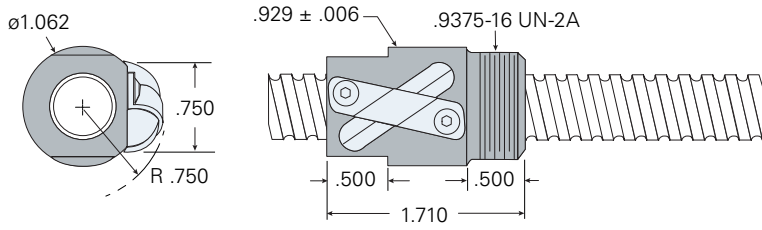

Standard Screw Lengths

Custom cut lengths available up to 12'

	Alloy
2'	CLB6124
4'	CLB6148
6'	CLB6172

For longer lengths, contact sales@helixlinear.com.

Flange

RFL6310 (alloy)

RFL6310SS (stainless)

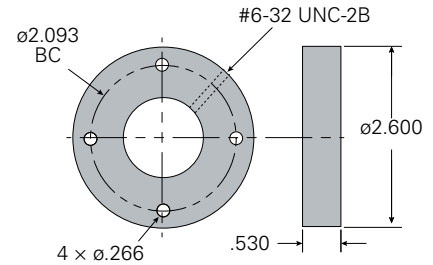

Wipers

(two wipers, one retainer)

BWS631

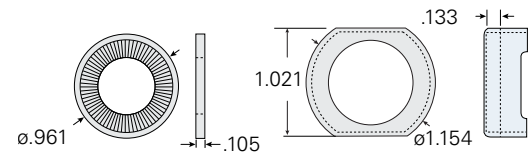

.631 diameter × .500 lead

Double Circuit Ball Nut

Ball Nut Part Number	Material	Helix	Dynamic Load (lb)	Static Load (lb)	Balls per Circuit/Nut	Nominal Ball Diameter (in)	Nut Weight (lb)	Torque to Raise 1 lb (in/lb)
HBN6315	Alloy	RH	960	5,565	37/74	.125	.27	0.088

Double Circuit Ball Nut with Adjustable Preload

Ball Nut Part Number	Material	Helix	Dynamic Load (lb)	Static Load (lb)	Balls per Circuit/Nut	Nominal Ball Diameter (in)	Nut Weight (lb)	Torque to Raise 1 lb (in/lb)
HBN6316	Alloy	RH	960	5,565	37/148	.125	.65	0.088

Ball Screw

double start

Ball Circle Diameter (in)	Lead (in)	Root Diameter (in)	Screw Weight (lb/ft)
.631	.500	.500	.81

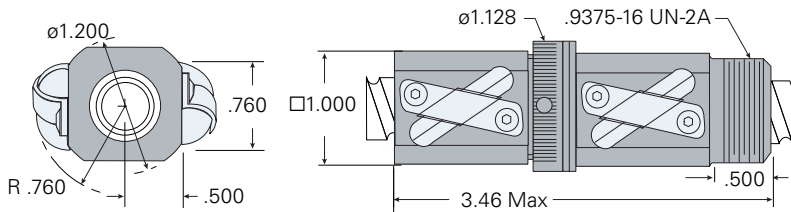
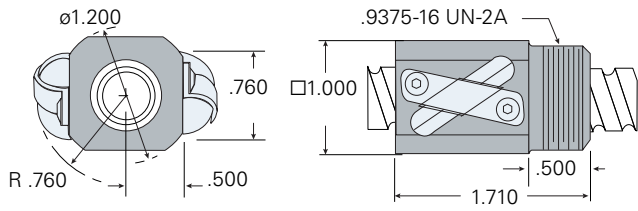

Flange

RFL6310 (alloy)

RFL6310SS (stainless)

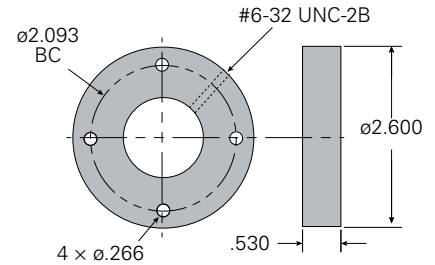

Standard Screw Lengths

Custom cut lengths available up to 12'

	Alloy
2'	CLB6324
4'	CLB6348
6'	CLB6372

For longer lengths, contact sales@helixlinear.com.

.750 diameter × .200 lead

Single Circuit Ball Nut

Ball Nut Part Number	Material	Helix	Dynamic Load (lb)	Static Load (lb)	Balls per Circuit/Nut	Nominal Ball Diameter (in)	Nut Weight (lb)	Torque to Raise 1 lb (in/lb)
HBN7501	Alloy	RH	1,105	8,571	70/70	.141	0.34	0.035

Double Circuit Ball Nut

Ball Nut Part Number	Material	Helix	Dynamic Load (lb)	Static Load (lb)	Balls per Circuit/Nut	Nominal Ball Diameter (in)	Nut Weight (lb)	Torque to Raise 1 lb (in/lb)
HBN7502	Alloy	RH	2,205	17,140	70/140	.141	0.79	0.035

Ball Screw

single start

Ball Circle Diameter (in)	Lead (in)	Root Diameter (in)	Screw Weight (lb/ft)
.750	.200	.602	1.20

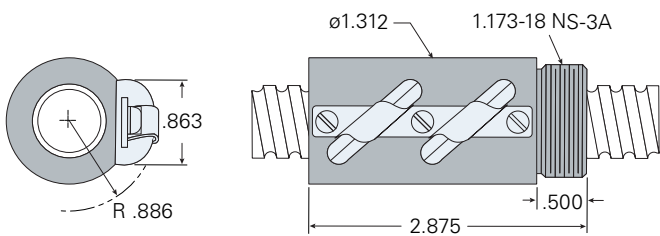
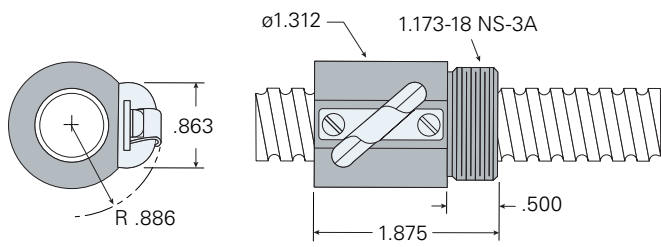

Standard Screw Lengths

Custom cut lengths available up to 12'

	Alloy		Alloy
2'	CLB7524	8'	CLB7596
4'	CLB7548	12'	CLB75144
6'	CLB7572		

For longer lengths, contact sales@helixlinear.com.

Flange

RFL7500 (alloy)

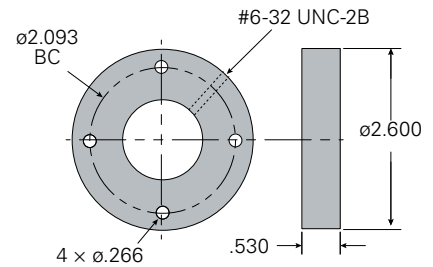

Wipers

(two wipers, one retainer)

BWS750

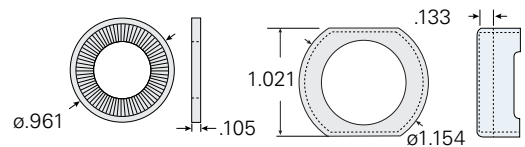

.750 diameter × .500 lead

Double Circuit Ball Nut

Ball Nut Part Number	Material	Helix	Dynamic Load (lb)	Static Load (lb)	Balls per Circuit/Nut	Nominal Ball Diameter (in)	Nut Weight (lb)	Torque to Raise 1 lb (in/lb)
HBN7552	Alloy	RH	2,726	17,430	78/156	.141	0.79	0.088

Ball Screw

single start

Ball Circle Diameter (in)	Lead (in)	Root Diameter (in)	Screw Weight (lb/ft)
.750	.500	.602	1.20



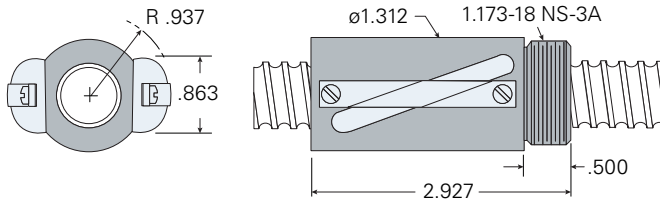

Flange

RFL7500 (alloy)

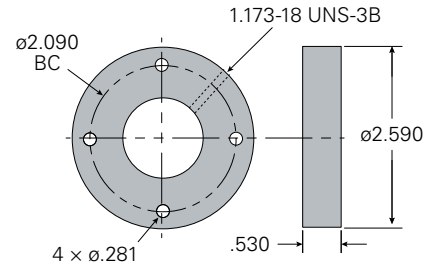

Standard Screw Lengths

Custom cut lengths available up to 12'

	Alloy		Alloy
2'	CLB7624	8'	CLB7696
4'	CLB7648	12'	CLB76144
6'	CLB7672		

For longer lengths, contact sales@helixlinear.com.

Wipers (two wipers, one retainer)

BWS750

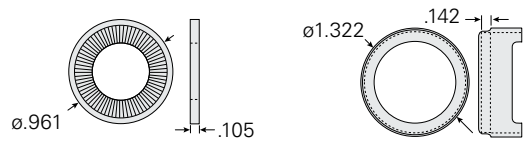

Helix ball screws and lead screws open the doors of trains.

.875 diameter × .200 lead

Double Circuit Ball Nut

Ball Nut Part Number	Material	Helix	Dynamic Load (lb)	Static Load (lb)	Balls per Circuit/Nut	Nominal Ball Diameter (in)	Nut Weight (lb)	Torque to Raise 1 lb (in/lb)
HBN8752	Alloy	RH	1,943	18,065	91/182	.125	0.80	0.035

Ball Screw

double start

Ball Circle Diameter (in)	Lead (in)	Root Diameter (in)	Screw Weight (lb/ft)
.875	.200	.735	1.76



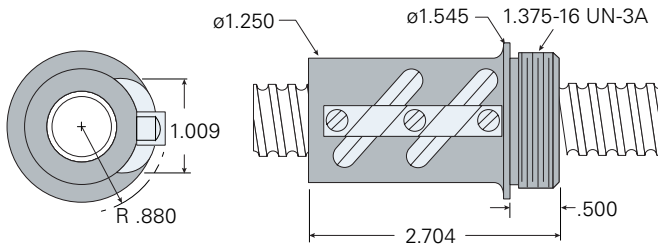

Flange

RFL8751 (alloy)

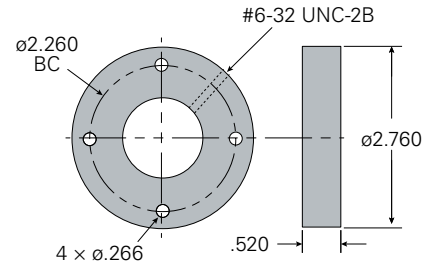

Standard Screw Lengths

Custom cut lengths available up to 12'

	Alloy		Alloy
2'	CLB8724	8'	CLB8796
4'	CLB8748	12'	CLB87144
6'	CLB8772		

For longer lengths, contact sales@helixlinear.com.

Wipers (two wipers, one retainer)

BWS875

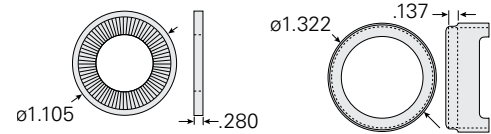

Helix ball screws are used in a wide variety of aerospace applications.

1.000 diameter × .250 lead

Single Circuit Ball Nut

Ball Nut Part Number	Material	Helix	Dynamic Load (lb)	Static Load (lb)	Balls per Circuit/Nut	Nominal Ball Diameter (in)	Nut Weight (lb)	Torque to Raise 1 lb (in/lb)
HBN1001	Alloy	RH	1,615	13,915	86/86	.156	0.80	0.044
HBN1003	Stainless	RH	291	2,506	86/86	.156	0.80	0.044

Double Circuit Ball Nut

Ball Nut Part Number	Material	Helix	Dynamic Load (lb)	Static Load (lb)	Balls per Circuit/Nut	Nominal Ball Diameter (in)	Nut Weight (lb)	Torque to Raise 1 lb (in/lb)
HBN1002	Alloy	RH	3,226	27,828	86/172	.156	1.2	0.044

Double Circuit Ball Nut with Adjustable Preload

Ball Nut Part Number	Material	Helix	Dynamic Load (lb)	Static Load (lb)	Balls per Circuit/Nut	Nominal Ball Diameter (in)	Nut Weight (lb)	Torque to Raise 1 lb (in/lb)
HBN1004	Alloy	RH	1,615	13,915	86/172	.156	1.9	0.044

Ball Screw

double start

Ball Circle Diameter (in)	Lead (in)	Root Diameter (in)	Screw Weight (lb/ft)
1.00	.250	.820	1.22

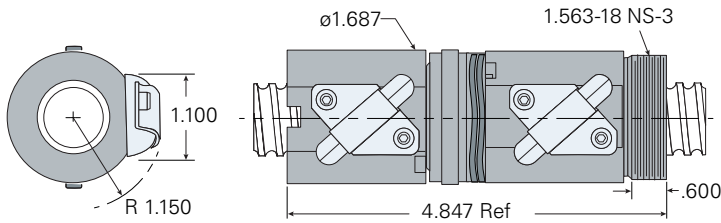
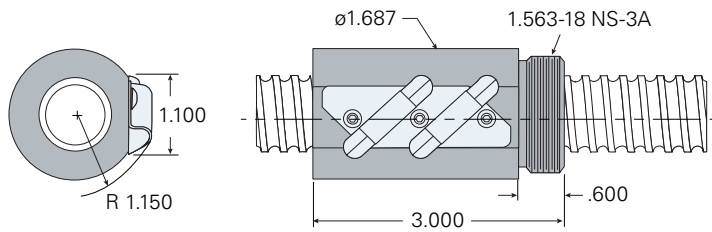
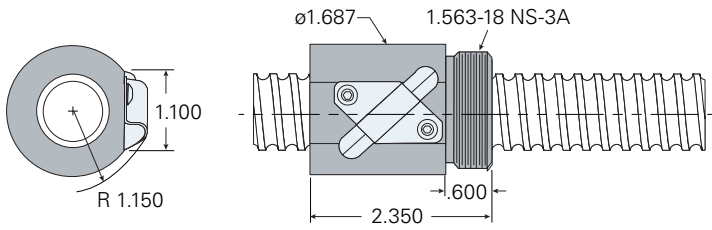

Flange

RFL 1000 (alloy)

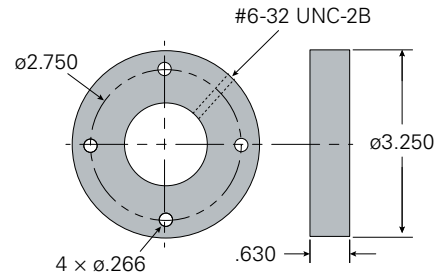

Standard Screw Lengths

Custom cut lengths available up to 12'

Alloy		Alloy	
2'	CLB1024	8'	CLB1096
4'	CLB1048	12'	CLB10144
6'	CLB1072		

For longer lengths, contact sales@helixlinear.com.

Wipers

(two wipers, one retainer)

BWS100

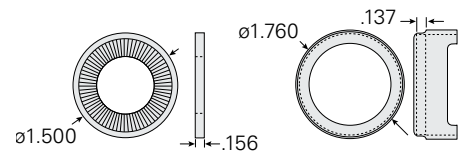

1.000 diameter × .500 lead

Double Circuit Ball Nut

Ball Nut Part Number	Material	Helix	Dynamic Load (lb)	Static Load (lb)	Balls per Circuit/Nut	Nominal Ball Diameter (in)	Nut Weight (lb)	Torque to Raise 1 lb (in/lb)
HBN1052	Alloy	RH	3,443	25,260	86/172	.156	1.2	0.088

Ball Screw

double start

Ball Circle Diameter (in)	Lead (in)	Root Diameter (in)	Screw Weight (lb/ft)
1.000	.500	.820	2.2



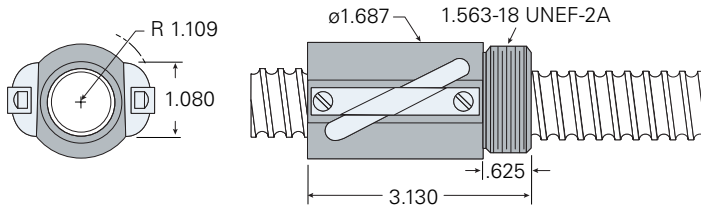

Standard Screw Lengths

Custom cut lengths available up to 12'

	Alloy		Alloy
2'	CLB1524	8'	CLB1596
4'	CLB1548	12'	CLB15144
6'	CLB1572		

For longer lengths, contact sales@helixlinear.com.

Flange

RFL1000 (alloy)

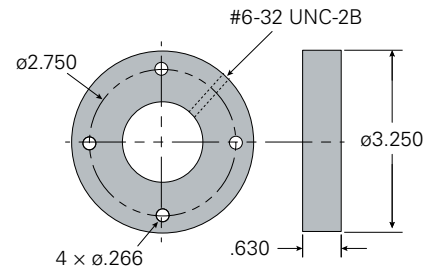

Wipers

(two wipers, one retainer)

BWS100

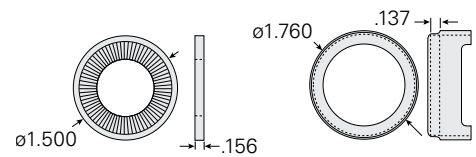

Ball screws are used in a wide variety of aerospace and defense applications.

1.000 diameter × 1.000 lead

Double Circuit Ball Nut

Ball Nut Part Number	Material	Helix	Dynamic Load (lb)	Static Load (lb)	Balls per Circuit/Nut	Nominal Ball Diameter (in)	Nut Weight (lb)	Torque to Raise 1 lb (in/lb)
HBN1102	Alloy	RH	2,148	11,931	50/100	.156	1.12	0.177

Four Circuit Ball Nut with Adjustable Preload

Ball Nut Part Number	Material	Helix	Dynamic Load (lb)	Static Load (lb)	Balls per Circuit/Nut	Nominal Ball Diameter (in)	Nut Weight (lb)	Torque to Raise 1 lb (in/lb)
HBN1103	Alloy	RH	2,071	11,650	50/200	.156	2.5	0.177

Ball Screw

four start

Ball Circle Diameter (in)	Lead (in)	Root Diameter (in)	Screw Weight (lb/ft)
1.000	1.000	.820	2.2

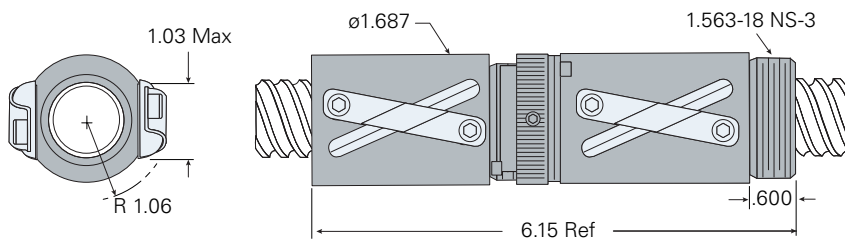
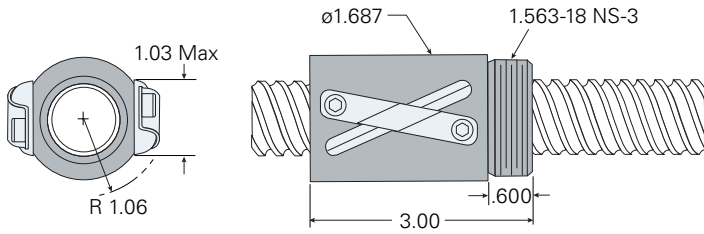

Flange

RFL1000 (alloy)

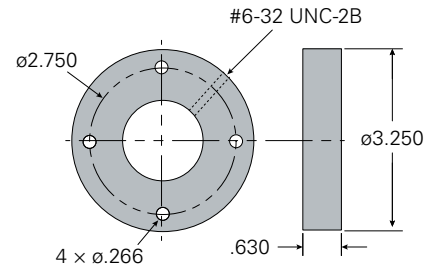

Standard Screw Lengths

Custom cut lengths available up to 12'

Alloy		Alloy	
2'	CLB1124	8'	CLB1196
4'	CLB1148	12'	CLB11144
6'	CLB1172		

For longer lengths, contact sales@helixlinear.com.

Wipers

(two wipers, one retainer)

BWS100

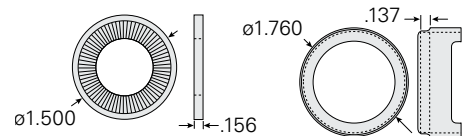

EZZE-MOUNT™ Bearing Supports

Introduction

Linear motion applications using a ball screw or an acme screw require this screw end machining matched with precision bearing mounts. Helix offers both the bearing mounts and end machining as a complete assembly.

Helix can provide the following end machining services:

- Screws cut to precision lengths
- Annealing
- Straightening
- CNC turning and milling
- Grinding
- Assembly of bearing mounts
- Inspection
- Specialized material handling and packaging

EZZE-MOUNT bearing blocks contain precision anti-friction bearings and are designed to be used with both ball screws and acme screws. Single and double bearing base mount and flange mount versions of EZZE-MOUNT bearing blocks are available.

Standard Ends: For each screw size, Helix has designed a family of standard machined ends applicable to a variety of bearing arrangements. The use of standard machined end designs offer quick deliveries.

Land Diameter is the outside diameter of the screw. The difference between the land diameter and the bearing journal is the resulting bearing shoulder.

Root Diameter: The diameter of the screw measured at the bottom of the thread. This diameter is used for determining journal sizes. If the bearing journal diameter is larger than the root diameter, thread tracings may be visible. Generally, these tracings do not have an effect on bearing performance.

Journal: A smooth diameter machined on the end of screw used as a mounting surface for bearings, couplings, pulleys, gears, etc.

Straightness: Although Helix screws are manufactured from straight, cylindrical material, internal stresses may cause the material to bend. When ordering random lengths or cut material without end machining, straightening is recommended. Handling or machining of screws can also cause the material to bend. Before, during and after machining, additional straightening is required.



Annealing is a process which softens the steel to allow for easier end machining. Annealing is usually required to machine the ends of ball screws. Due to its effect on the precision lead accuracies of PRS and GTS ball screws, annealing is not recommended for these products. Hard turning will allow the screw hardened thread to be removed. Acme screws typically do not require annealing before end machining.

End Fixity refers to the method by which the ends of the screw are supported. The degree of end fixity is related to the amount of restraint of the ends of the screw.

The three basic types of end fixity are:

- Free** No support
- Simple** Shaft restrained against radial or axial loads
- Fixed** Shaft rigidly restrained against radial, axial and moment loads

See page 9 for a more detailed definition of end fixity.

Locknut threads are machined to allow the bearing retention on the screw shaft by means of a locknut. The thread used on standard machined ends follows American National Form NS Class 3. Precision ground locknuts are available from Helix on special order.

Undercuts and Radii: Whenever a shaft changes diameter, an undercut or a radius is machined into the transition to minimize stress concentration. Undercuts are preferred for bearing shoulders because they allow clearance for the corner of the bearing.

Figure 11

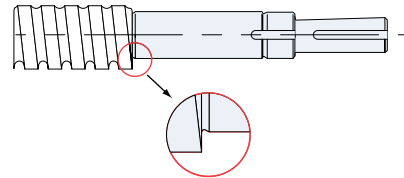

Concentricity refers to multiple diameters sharing the same center. For end machining, close concentricity allows all components to rotate around the same axis resulting in smooth operation and long operating life.

Approval Drawings: If custom ends or special dimensions are desired, an approval drawing can be developed after the order is entered. These drawings will show all the critical dimensions with appropriate tolerance and require customer signature prior to manufacture.

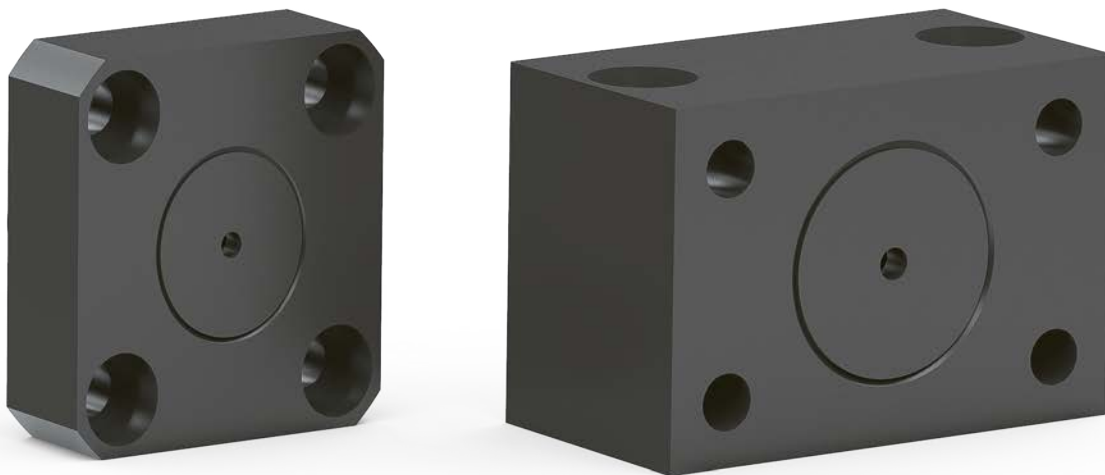

EZZE-MOUNT™ Bearing Supports

Quick Reference Guide

EZZE-MOUNT™

Dia × Lead	End Code Type		Universal Mounts		Flange Mounts	
	1,2,3	4	Double	Single	Double	Single
.375 × .125	7	4	EZM-1007	EZM-4007	EZF-1007	EZF-4007
.500 × .200	10	6	EZM-3010	EZM-4010	EZF-3010	EZF-4010
.500 × .500	8	6	EZM-1008	EZM-4008	EZF-1008	EZF-4008
.631 × .200	12	8	EZM-3012	EZM-4012	EZF-3012	EZF-4012
.631 × .500	12	8	EZM-3012	EZM-4012	EZF-3012	EZF-4012
.631 × 1000	12	8	EZM-3012	EZM-4012	EZF-3012	EZF-4012
.750 × .200	15	8	EZM-3015	EZM-4015	EZF-3015	EZF-4015
.750 × .500	15	8	EZM-3015	EZM-4015	EZF-3015	EZF-4015
.875 × .200	17	10	EZM-3017	EZM-4017	EZF-3017	EZF-4017
1.000 × .200	20	12	EZM-2020	EZM-4020	EZF-2020	EZF-4020
1.000 × .250	20	12	EZM-2020	EZM-4020	EZF-2020	EZF-4020
1.000 × .500	20	12	EZM-2020	EZM-4020	EZF-2020	EZF-4020
1.000 × 1000	20	12	EZM-2020	EZM-4020	EZF-2020	EZF-4020
1.150 × .200	25	16	EZM-3025	EZM-4025	EZF-3025	EZF-4025
1.171 × .413	20	12	EZM-2020	EZM-4020	EZF-2020	EZF-4020
1.250 × .200	25	16	EZM-3025	EZM-4025	EZF-3025	EZF-4025
1.250 × .500	25	16	EZM-3025	EZM-4025	EZF-3025	EZF-4025
1.500 × .200	30	19	EZM-2030	EZM-4030	EZF-2030	EZF-4030
1.500 × .250	30	19	EZM-2030	EZM-4030	EZF-2030	EZF-4030
1.500 × .473	25	16	EZM-3025	EZM-4025	EZF-3025	EZF-4025
1500 × .500	25	16	EZM-3025	EZM-4025	EZF-3025	EZF-4025



EZM Double Bearing

Figure 12

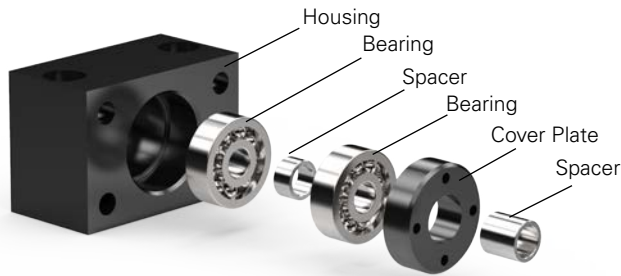

EZM Single Bearing

Figure 13

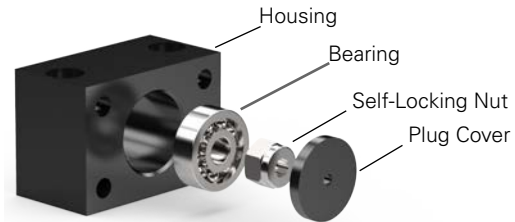

Part Number		Bearing	Locknut	Locknuts Max Axial Load	
Universal	Flanged			lb	kg
BRG-107*	EZF-1007*	627-2RS1	LN107	1,800	816.5
BRG-108*	EZF-1008*	608-2RS1	LN108	2,300	1,043.3
BRG-109*	EZF-1009*	609-2RS1	LN109	2,300	1,043.3
BRG-301*	EZF-3010*	6000-2RS1	LN301	4,100	1,859.7
BRG-302	EZF-3012	7301	LN302	6,900	3,129.8
BRG-305	EZF-3015	7302	LN305	8,100	3,674.1
BRG-307	EZF-3017	7303	LN307	9,900	4,490.6
BRG-200	EZF-2020	7204	LN200	13,200	5,987.4
BRG-325	EZF-3025	7305	LN325	16,200	7,348.2

Bearings marked with an asterisk (*) use two deep groove ball bearings.

All others use two angular contact (40°) universal ground ball bearings in back-to-back configuration.



Helix ball screws are used in medical infusion pumps.

EZZE-MOUNT™

Universal Double-Bearing Support

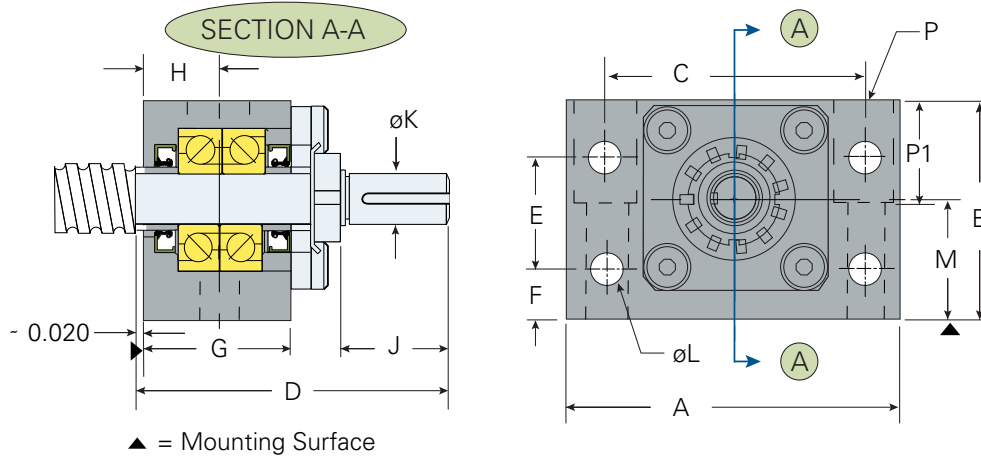

Part #	A (in)	B (in)	C (in)	D (in)	E (in)	F (in)	G (in)
EZM-1007	2.00	1.38	1.50	1.94	.88	.25	1.06
EZM-1008	2.00	1.38	1.50	2.00	.88	.25	1.06
EZM-1009	2.75	2.00	2.00	2.38	1.38	.31	1.19
EZM-3010	2.75	2.00	2.00	2.50	1.38	.31	1.19
EZM-3012	3.50	2.22	2.75	3.29	1.25	.50	1.38
EZM-3015	3.50	2.52	2.75	3.50	1.25	.80	1.38
EZM-3017	4.50	2.69	3.38	3.65	1.38	.62	1.69
EZM-2020	5.00	3.03	3.75	4.03	1.50	.75	1.72
EZM-3025	6.50	3.69	4.75	4.45	2.00	.88	1.94



H (in)	J (in)	ØK (in ⁺⁰ _{-.001})	ØL (in)	M (in)	P				
					Suggested Bolt Size	Ø Thru (in)	Ø C'bore (in)	P1 (in)	End Code
.50	.46	.187 - .186	.22 (4)	.687	¼ × 1⅜ (2)	.28	.41	.41	7
.50	.56	.250 - .249	.22 (4)	.687	¼ × 1⅜ (2)	.28	.41	.41	8
.56	.56	.250 - .249	.28 (4)	1.00	⅝ × 2 (2)	.34	.56	.50	9
.56	.69	.312 - .311	.28 (4)	1.00	⅝ × 2 (2)	.34	.56	.50	10
.69	1.30	.406 - .405	.28 (4)	1.187	⅜ × 1¾ (2)	.41	1.00	.62	12
.69	1.30	.500 - .499	.28 (4)	1.438	⅜ × 2⅛ (2)	.41	1.00	.62	15
.84	1.30	.500 - .499	.41 (4)	1.500	½ × 2¼ (2)	.53	1.25	.88	17
.86	1.30	.625 - .624	.47 (4)	1.625	⅝ × 2½ (2)	.66	1.50	1.00	20
.97	1.61	.750 - .749	.66 (4)	1.875	⅞ × 3¼ (2)	.91	1.75	1.38	25

EZZE-MOUNT™

Universal Single-Bearing Support

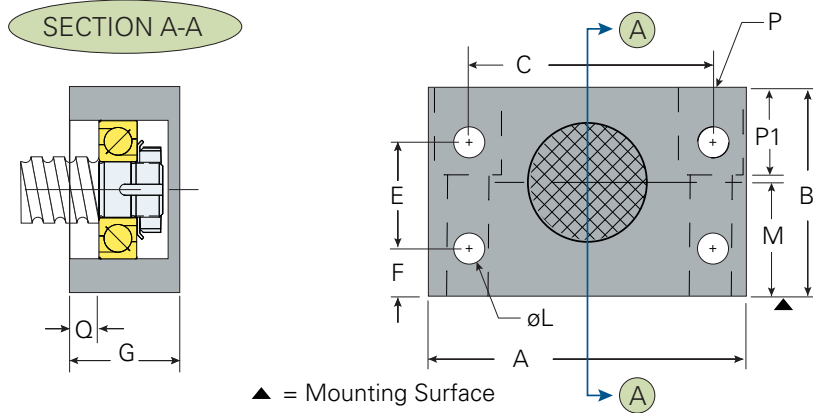

Part #	A (in)	B (in)	C (in)	D (in)	E (in)	F (in)	G (in)
EZM-4007	2.00	1.38	1.50	.19	.88	.25	1.06
EZM-4008	2.00	1.38	1.50	.19	.88	.25	1.06
EZM-4009	2.75	2.00	2.00	.38	1.38	.31	1.19
EZM-4010	2.75	2.00	2.00	.38	1.38	.31	1.19
EZM-4012	3.50	2.22	2.75	.33	1.25	.50	1.38
EZM-4015	3.50	2.52	2.75	.33	1.25	.80	1.38
EZM-4017	4.50	2.69	3.38	.38	1.38	.62	1.69
EZM-4020	5.00	3.03	3.75	.50	1.50	.75	1.72
EZM-4025	6.50	3.69	4.75	.52	2.00	.88	1.94

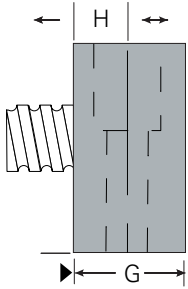

H (in)	L (in)	M (in)	P				End Code
			Suggested Bolt Size	∅ Thru (in)	∅ C'bore (in)	P1 (in)	
.50	.22 (4)	.69	1/4 × 1 3/8 (2)	.28	.41	.41	7
.50	.22 (4)	.69	1/4 × 1 3/8 (2)	.28	.41	.41	8
.56	.28 (4)	1.00	5/16 × 2 (2)	.34	.56	.50	9
.56	.28 (4)	1.00	5/16 × 2 (2)	.34	.56	.50	10
.69	.28 (4)	1.19	3/8 × 1 3/4 (2)	.41	1.00	.62	12
.69	.28 (4)	1.44	3/8 × 2 1/8 (2)	.41	1.00	.62	15
.84	.41 (4)	1.50	1/2 × 2 1/4 (2)	.53	1.25	.88	17
.86	.47 (4)	1.63	5/8 × 2 1/2 (2)	.66	1.50	1.00	20
.97	.66 (4)	1.88	7/8 × 3 1/4 (2)	.91	1.75	1.38	25

EZZE-MOUNT™

Flanged Double-Bearing Support

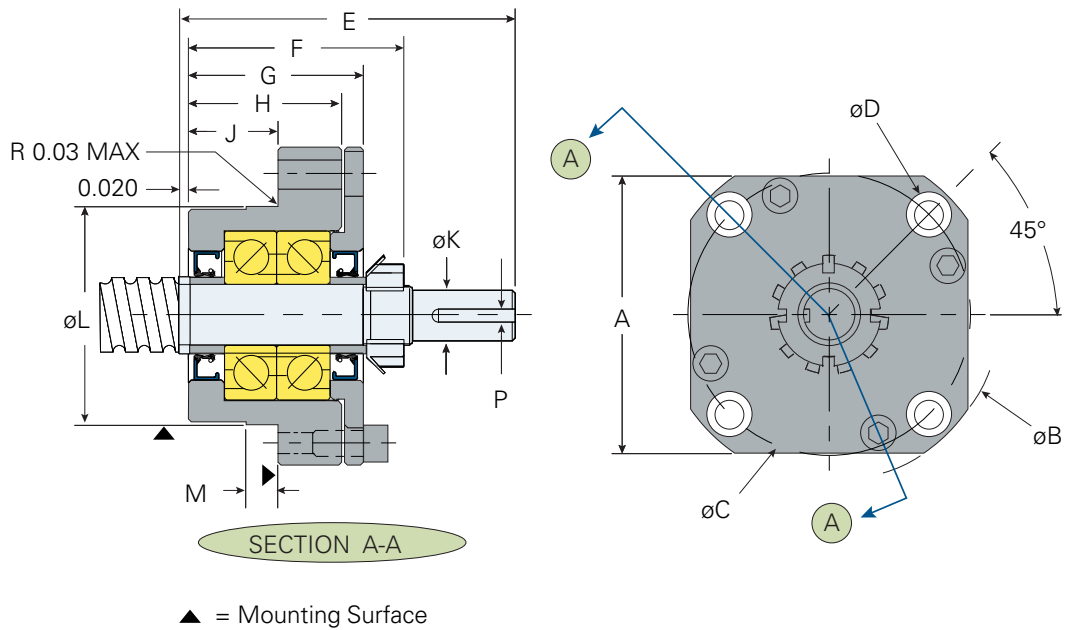

Part #	A (in)	B (in)	C (in)	øD Thru (in)	ø C'bore (in)	E (in)	F (in)	G (in)
EZF-1007	1.88	2.44	1.875	.266	.44	1.94	1.44	1.06
EZF-1008	1.88	2.44	1.875	.266	.44	2.00	1.44	1.06
EZF-1009	2.00	2.60	2.000	.266	.44	2.38	1.81	1.33
EZF-3010	2.00	2.60	2.000	.266	.44	2.50	1.81	1.33
EZF-3012	2.50	3.17	2.500	.266	.44	3.29	1.99	1.57
EZF-3015	2.70	3.27	2.750	.281	.44	3.50	2.10	1.71
EZF-3017	3.38	4.03	3.250	.344	.53	3.65	2.33	1.93
EZF-2020	3.38	4.03	3.250	.344	.53	4.03	2.71	1.98
EZF-3025	4.38	5.31	4.250	.531	.81	4.45	2.89	2.36



H (in)	J (in)	ØK (in)	L (in)	M (in)	P (in)	End Code
.82	.50	.187 - .186	1.3775 - 1.3770	.188	.063	7
.82	.50	.250 - .249	1.3775 - 1.3770	.188	.094	8
1.09	.71	.250 - .249	1.4967 - 1.4951	.188	.094	9
1.09	.71	.312 - .311	1.4967 - 1.4951	.190	.125	10
1.38	.75	.406 - .405	1.8894 - 1.8888	.312	.125	12
1.50	.88	.500 - .499	2.1256 - 2.1250	.312	.125	15
1.63	.94	.500 - .499	2.5193 - 2.5185	.312	.125	17
1.72	1.03	.625 - .624	2.5193 - 2.5185	.312	.188	20
1.94	1.19	.750 - .749	3.1492 - 3.1482	.375	.188	25

EZZE-MOUNT™

Flanged Single-Bearing Support

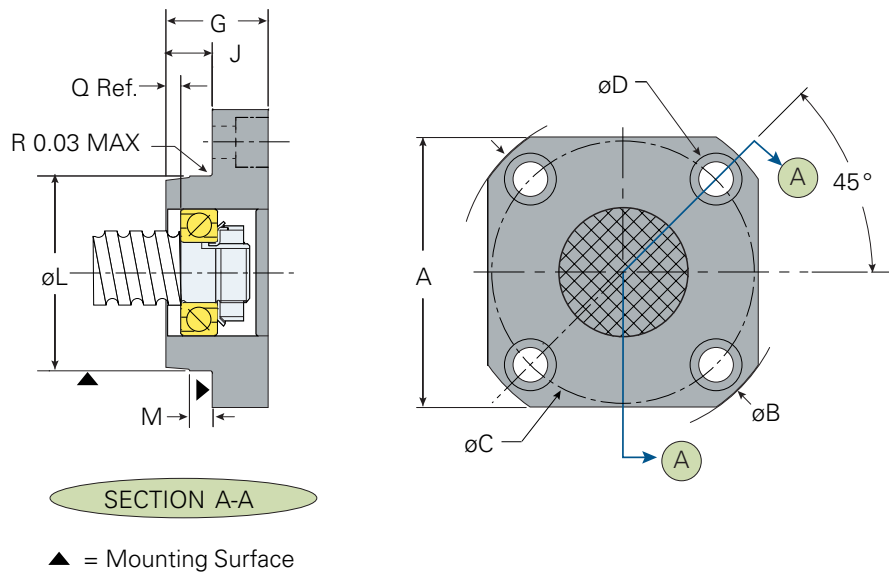

Part No.	A (in)	B (in)	C (in)	øD Thru (in)	ø C'bore (in)
EZF-4007	1.88	2.44	1.875	.266	.44
EZF-4008	1.88	2.44	1.875	.266	.44
EZF-4009	2.00	2.60	2.000	.266	.44
EZF-4010	2.00	2.60	2.000	.266	.44
EZF-4012	2.50	3.17	2.500	.266	.44
EZF-4015	2.70	3.27	2.750	.281	.44
EZF-4017	3.38	4.03	3.250	.344	.53
EZF-4020	3.38	4.03	3.250	.344	.53
EZF-4025	4.38	5.31	4.250	.531	.81

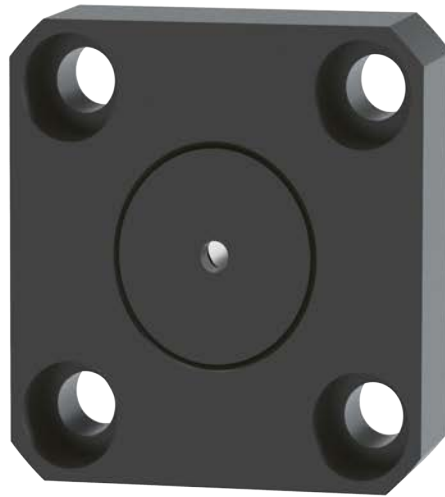

G (in)	J (in)	L (in)	M (in)	Q (in)	End Code
1.00	.40	1.3775 - 1.3770	.188	.13	7
1.00	.40	1.3775 - 1.3770	.188	.13	8
1.00	.44	1.4957 - 1.4951	.188	.13	9
1.00	.44	1.4957 - 1.4951	.190	.13	10
1.15	.55	1.8894 - 1.4951	.312	.13	12
1.25	.63	2.1256 - 2.1250	.312	.20	15
1.32	.63	2.5193 - 2.5185	.312	.20	17
1.47	.72	2.5193 - 2.5185	.312	.20	20
1.67	.76	3.1492 - 3.1482	.375	.25	25

EZZE-MOUNT™

Universal Bearing Support with Motor Mount

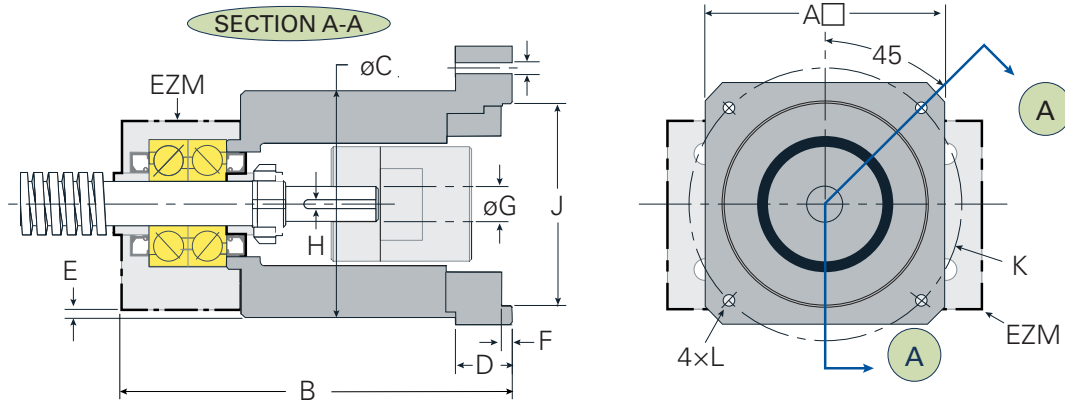

EZZE Mount™	NEMA Frame	Reference number	A (in)	B (in)	C (in)	D (in)	E (in)
EZM-1008-17	17	U1	1.75	3.35	1.75	0.52	.19
EZM-1009-23	23	U2	2.50	4.10	2.50	0.38	.26
EZM-3010-23	23	U2	2.50	4.10	2.50	0.38	.26
EZM-3012-23	23	U2	2.50	4.48	2.50	0.38	.10
EZM-3012-34	34	U3	3.25	4.92	2.50	0.81	.10
EZM-3015-23	23	U2	2.50	4.90	2.50	0.54	–
EZM-3015-34	34	U3	3.25	5.13	2.50	0.81	.19
EZM-3017-34	34	U3	3.25	5.56	3.12	0.81	.13
EZM-2020-34	34	U3	3.44	5.96	3.44	0.81	.10
EZM-3025-34	34	U3	4.00	6.44	4.38	0.81	.31

Figure 14: Universal bearing support for a ball screw assembly



The Universal Bearing Support with Motor Mount is designed to simplify and enhance the installation process of ball screw assemblies. This system incorporates a motor mount for precise and efficient setup.

For assistance in configuring a ball screw assembly with a motor mount to meet your requirements, please contact our sales team at sales@helixlinear.com

F (in)	G (in)	H (in)	J (in)	K (in)	L
.25	.25	.094	.871 ⁺⁰ _{-.003}	1.725	#8-32
.19	.38	.125	1.506 ⁺⁰ _{-.003}	2.625	#10-32
.19	.38	.125	1.506 ⁺⁰ _{-.003}	2.625	#10-32
.19	.38	.125	1.506 ⁺⁰ _{-.003}	2.625	#10-32
.16	.50	.125	2.882 ⁺⁰ _{-.004}	3.875	#10-32
.19	.38	.125	1.506 ⁺⁰ _{-.003}	2.625	#10-32
.16	.50	.125	2.882 ⁺⁰ _{-.004}	3.875	#10-32
.16	.50	.125	2.882 ⁺⁰ _{-.004}	3.875	#10-32
.16	.50	.125	2.882 ⁺⁰ _{-.004}	3.875	#10-32
.16	.50	.125	2.882 ⁺⁰ _{-.004}	3.875	#10-32

Figure 15: Universal bearing support with motor mount for a ball screw assembly

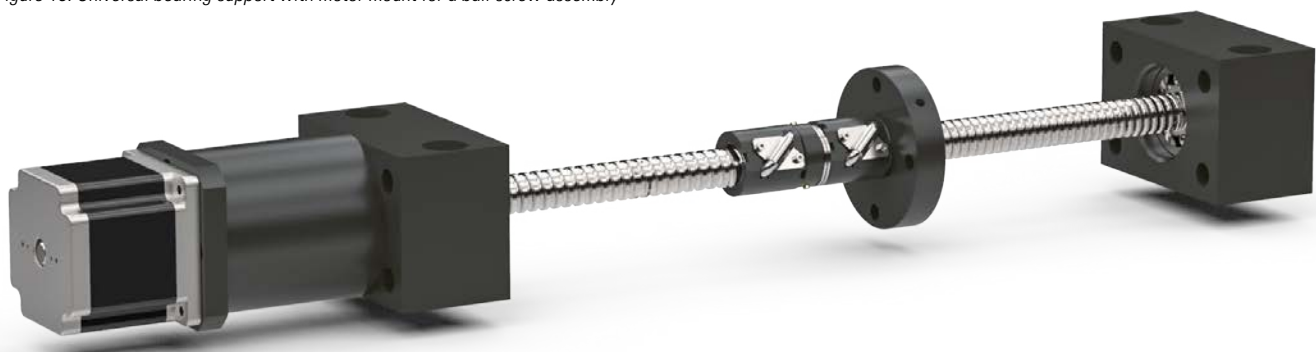

EZZE-MOUNT™

Flanged Bearing Support with Motor Mount

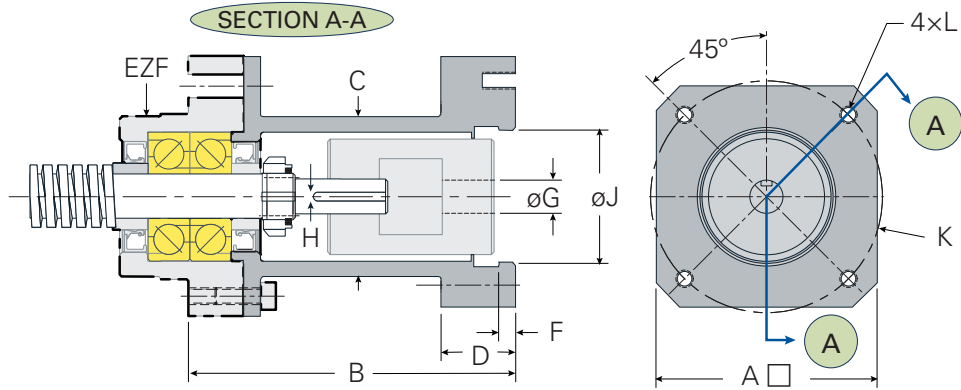

EZZE Mount™	NEMA Frame	Reference number	A (in)	B (in)	C (in)	D (in)
EZF-1008-17	17	Y1	1.750	2.840	2.200	.520
EZF-1009-23	23	Y2	2.500	3.410	2.100	.880
EZF-3010-23	23	Y2	3.440	4.920	2.370	1.670
EZF-3012-23	23	Y2	4.500	5.670	2.370	2.410
EZF-3012-34	34	Y3	4.000	5.780	3.000	1.670
EZF-3015-23	23	Y2	4.500	6.530	3.000	2.410
EZF-3015-34	34	Y3	2.500	3.410	2.100	.880
EZF-3017-34	34	Y3	2.500	3.700	1.810	.880
EZF-2020-34	34	Y3	2.500	3.840	1.980	.880
EZF-3025-34	34	Y3	3.250	4.620	2.250	1.670

Figure 16: Flanged bearing support for a ball screw assembly



The Universal Double-Bearing with Flange Motor Mount is designed to streamline the installation of lead screw assemblies, featuring an EZZE-MOUNT bearing support and motor mount for precise and efficient setup.

For assistance in configuring your ball screw assembly with a motor mount, please reach out to our sales team at sales@helixlinear.com

F (in)	G (in)	H (in)	J (in)	K (in)	L
.250	.250	.094	.871 ⁺⁰ _{-.003}	1.725	#8-32
.190	.380	.125	1.506 ⁺⁰ _{-.003}	2.625	#10-32
.190	.380	.125	1.506 ⁺⁰ _{-.003}	2.625	#10-32
.190	.380	.125	1.506 ⁺⁰ _{-.003}	2.625	#10-32
.160	.500	.125	2.882 ⁺⁰ _{-.004}	3.875	#10-32
.190	.380	.125	1.506 ⁺⁰ _{-.003}	2.625	#10-32
.160	.500	.125	2.882 ⁺⁰ _{-.004}	3.875	#10-32
.160	.500	.125	2.882 ⁺⁰ _{-.004}	3.875	#10-32
.160	.500	.125	2.882 ⁺⁰ _{-.004}	3.875	#10-32
.160	.500	.125	2.882 ⁺⁰ _{-.004}	3.875	#10-32

Figure 17: Flanged bearing support with motor mount for a ball screw assembly



End Machining

TYPE 1

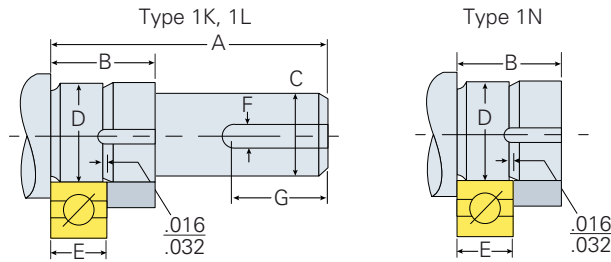

Code	A (in)	B (in)	C (in)	D (in)	E (in)	F (in)	G (in)	Lock nut	Lock washer
7	1.12	.65	.186	.2757/.2754	.276	.063	.34	1/4-20	-
8	1.31	.68	.249	.3151/.3148	.276	.094	.46	5/16-24	-
9	1.38	.72	.249	.3544/.3541	.315	.094	.46	5/16-24	-
10	1.37	.69	.311	.3939/.3936	.315	.125	.50	N-00	W-00
12	2.11	.81	.405	.4726/.4723	.394	.125	1.00	N-01	W-01
15	2.15	.84	.499	.5908/.5905	.433	.125	1.00	N-02	W-02
17	2.23	.92	.499	.6695/.6692	.472	.125	1.00	N-03	W-03
20	2.37	1.06	.624	.7877/.7873	.551	.188	1.00	N-04	W-04
25	2.68	1.12	.749	.9846/.9842	.591	.188	1.00	N-05	W-05

TYPE 2

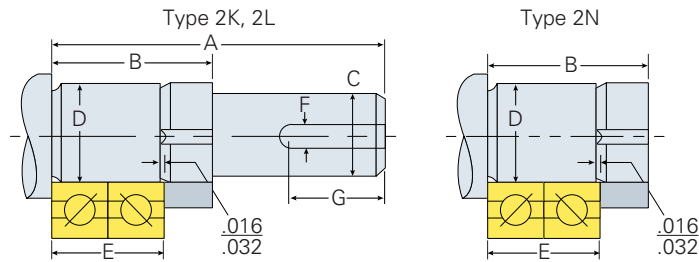

Code	A (in)	B (in)	C (in)	D (in)	E (in)	F (in)	G (in)	Lock nut	Lock washer
7	1.12	.65	.186	.2757/.2754	.552	.063	.34	1/4-20	-
8	1.31	.68	.249	.3151/.3148	.552	.094	.46	5/16-24	-
9	1.38	.72	.249	.3544/.3541	.630	.094	.46	5/16-24	-
10	1.37	.69	.311	.3939/.3936	.630	.125	.50	N-00	W-00
12	2.11	.81	.405	.4726/.4723	.788	.125	1.00	N-01	W-01
15	2.15	.84	.499	.5908/.5905	.866	.125	1.00	N-02	W-02
17	2.23	.92	.499	.6695/.6692	.944	.125	1.00	N-03	W-03
20	2.37	1.06	.624	.7877/.7873	1.102	.188	1.00	N-04	W-04
25	2.68	1.12	.749	.9846/.9842	1.182	.188	1.00	N-05	W-05

TYPE 3

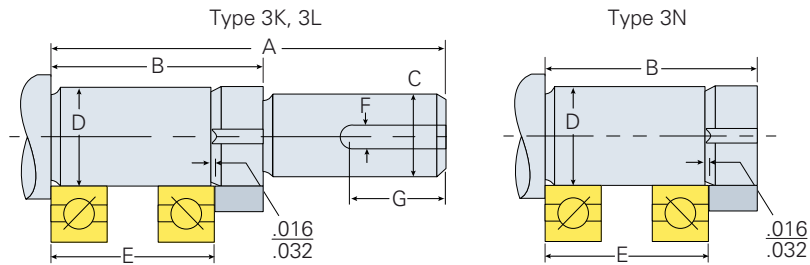

Code	A (in)	B (in)	C (in)	D (in)	E (in)	F (in)	G (in)	Lock nut	Lock washer
7	1.94	1.48	.186	.2757/.2754	1.104	.063	.34	1/4-20	-
8	2.00	1.44	.249	.3151/.3148	1.060	.094	.46	5/16-24	-
9	2.38	1.81	.249	.3544/.3541	1.438	.094	.46	5/16-24	-
10	2.50	1.81	.311	.3939/.3936	1.438	.125	.50	N-00	W-00
12	3.29	1.99	.405	.4726/.4723	1.576	.125	1.00	N-01	W-01
15	3.50	2.18	.499	.5908/.5905	1.732	.125	1.00	N-02	W-02
17	3.65	2.33	.499	.6695/.6692	1.888	.125	1.00	N-03	W-03
20	4.03	2.71	.624	.7877/.7873	2.204	.188	1.00	N-04	W-04
25	4.45	2.89	.749	.9846/.9842	2.364	.188	1.00	N-05	W-05

TYPE 4

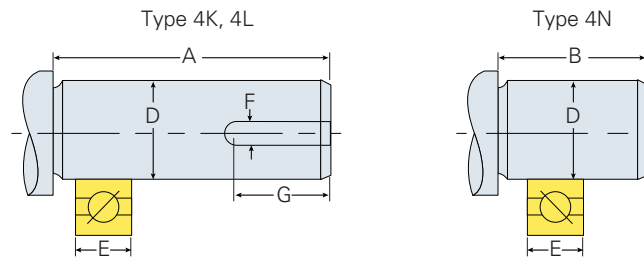

Code	A (in)	B (in)	D (in)	F (in)	G (in)
4	1.38	.50	.250	.063	0.63
6	1.50	.75	.375	.125	0.75
8	2.63	1.00	.500	.125	1.50
10	2.63	1.25	.625	.188	1.50
12	2.72	1.50	.750	.188	1.50
16	2.84	1.50	1.000	.25	1.50



23200 Commerce Park Road
Beachwood, Ohio 44122 USA
sales@helixlinear.com
216-485-2232

helixlinear.com